

September 2015

# Hybrid Capture<sup>®</sup> System Automated Plate Washer User Manual



**CE**

**IVD**

**REF**

6000-00174 (120 V)  
6000-00175 (240 V)



QIAGEN  
19300 Germantown Road  
Germantown, MD 20874  
USA

**EC**

**REP**

QIAGEN GmbH  
QIAGEN Strasse 1  
40724 Hilden  
GERMANY

1087789EN Rev. 02

---

Trademarks: QIAGEN<sup>®</sup>, Sample to Insight<sup>®</sup>, *digene*<sup>®</sup>, HC2<sup>®</sup>, Hybrid Capture<sup>®</sup> (QIAGEN Group); Combitip<sup>®</sup>, Eppendorf<sup>®</sup> (Eppendorf AG); Delrin<sup>®</sup>, Teflon<sup>®</sup> (E.I. du Pont de Nemours and Company); Santoprene<sup>™</sup> (Exxon Mobil Corporation); Tygon<sup>®</sup> (Saint-Gobain Performance Plastics Corporation).  
Registered names, trademarks, etc., used in this document, even when not specifically marked as such, are not to be considered unprotected by law.  
© 2015 QIAGEN, all rights reserved.

---

# Contents

1	Introduction .....	6
1.1	General information .....	6
1.1.1	Technical assistance .....	6
1.1.2	Version management .....	6
1.2	Intended use .....	6
2	Safety Information .....	7
2.1	Proper use .....	8
2.2	Electrical safety .....	9
2.3	Environment .....	10
2.4	Biological safety .....	11
2.5	Waste disposal .....	11
2.6	Symbols .....	12
3	Unpacking .....	14
4	Installation .....	15
4.1	Selecting the AC line voltage .....	15
4.1.1	120 line voltage selection .....	15
4.1.2	220 line voltage selection .....	16
4.2	Manifold installation .....	17
4.3	Setting up the reservoirs .....	18
5	Functional Description .....	21
5.1	Keypad and display .....	22
5.2	Positive-displacement pump .....	24

---

5.3	Air pump and aspirate needles.....	24
5.4	Waste reservoir.....	24
6	General Operation.....	25
6.1	Functional verification.....	25
6.2	Maintenance rinse function.....	26
6.3	Prime cycle.....	26
6.4	Rinse cycle.....	27
6.5	Wash cycle.....	27
6.6	Emptying the waste reservoir.....	28
6.7	Powering OFF.....	28
7	Maintenance.....	29
7.1	Monthly maintenance.....	29
7.1.1	Cleaning.....	29
7.1.2	Flushing the reservoir tubing.....	31
7.1.3	Replacing aspirate exhaust filter.....	32
7.2	Cleaning manifold needles.....	32
7.3	Installing manifold tubing.....	34
7.4	Cleaning reagent spills.....	36
7.5	Repositioning the syringe plunger.....	37
7.6	Installing fuses.....	39
7.7	Repair.....	41
7.8	Decontamination before shipping.....	41
7.9	Maintenance schedule.....	42
8	Troubleshooting.....	43

---

9	Technical Data .....	49
9.1	Operating conditions .....	49
9.2	Transport conditions .....	50
9.3	Storage conditions .....	50
10	Ordering Information .....	51
	Appendix A – Waste Electrical and Electronic Equipment (WEEE) .....	52
	Appendix B – Warranty .....	53

---

# 1 Introduction

The Hybrid Capture System (HCS) Automated Plate Washer has been designed specifically for use with the *digene*<sup>®</sup> Hybrid Capture 2 (HC2<sup>®</sup>) DNA tests.

Read this user manual before operating the HCS Automatic Plate Washer.

## 1.1 General information

### 1.1.1 Technical assistance

For technical assistance and more information, please see our Technical Support Center at **[www.qiagen.com/TechSupportCenter](http://www.qiagen.com/TechSupportCenter)** or contact QIAGEN Technical Services or a local distributor.

### 1.1.2 Version management

This document is *Hybrid Capture System Automatic Plate Washer User Manual*; see the front cover of this user manual for document number and revision.

## 1.2 Intended use

The HCS Automatic Plate Washer is intended for use in conjunction with *digene* HC2 DNA tests as described in the respective *digene* HC2 DNA test instructions for use.

---

## 2 Safety Information

This manual contains information about warnings and cautions that must be followed by the user to ensure safe operation of the HCS Automated Plate Washer and to maintain the instrument in a safe condition.

**WARNING** The term **WARNING** is used to inform you about situations that could result in personal injury to you or other persons.



Details about these circumstances are provided to avoid personal injury to you or other persons.

**CAUTION** The term **CAUTION** is used to inform you about situations that could result in damage to the instrument or other equipment.



Details about these circumstances are provided to avoid damage to the instrument or other equipment.

Before using the instrument, it is essential to read this manual carefully and to pay particular attention to any details it contains concerning hazards that may arise from the use of the instrument.

The details given in this manual are intended to supplement, not supersede, the normal safety requirements prevailing in the user's country.

## 2.1 Proper use

### **WARNING/ CAUTION** Risk of personal injury and material damage



Improper use of the HCS Automated Plate Washer may cause personal injuries to the user or damage to the instrument.

The HCS Automated Plate Washer must only be operated by qualified personnel who have been appropriately trained.

### **WARNING** Risk of personal injury



In case of an emergency or malfunction, power OFF the HCS Automated Plate Washer using the power switch at the rear of the instrument and unplug the power cord from the wall power outlet. Contact QIAGEN Technical Services for assistance.

Wear powder-free gloves to prevent alkaline phosphatase contamination of the HCS Automated Plate Washer. Substances that may contain alkaline phosphatase include Detection Reagent 1, bacteria, mold, saliva, hair and skin oils. Exogenous alkaline phosphatase can react with the Detection Reagent 2 of the *digene* HC2 DNA test and cause false-positive test results.



---

## 2.2 Electrical safety

Only operate the HCS Automated Plate Washer with the power cord provided with the instrument. For satisfactory and safe operation of the HCS Automated Plate Washer, it is essential that the line power cord is connected to true electrical earth (ground).

Make sure that the HCS Automated Plate Washer is rated for the proper voltage (see "Selecting the AC line voltage," page 15). Record the serial number, located on the back of the instrument, in a secure location for future reference.

### **WARNING** Electrical hazard



Any interruption of the protective conductor (earth/ground lead) or disconnection of the protective conductor terminal is likely to make the instrument dangerous. Intentional interruption is prohibited.

Lethal voltages are contained inside the instrument. When the instrument is connected to line power, terminals may be live, and opening covers or removing parts is likely to expose live parts. Do not remove the cover.

When working with the HCS Automated Plate Washer:

- Make sure the line power cord is connected to a line power outlet that has a protective conductor (earth/ground).
- Do not operate the instrument with any covers or parts removed.
- If the instrument becomes electrically unsafe for use, make the instrument inoperative by powering OFF the HCS Automated Plate Washer and unplugging the instrument from the wall power outlet. Secure the instrument against unauthorized or unintentional operation. Contact QIAGEN Technical Services for assistance.

---

The instrument is likely electrically unsafe when:

- The instrument shows visible damage
- The line power cord shows signs of damage
- The instrument has been stored under unfavorable conditions for a prolonged period
- The instrument has been subjected to severe transport stresses

## 2.3 Environment

Locate the HCS Automated Plate Washer indoors and shield the instrument from excess exposure to dust, vibration, strong magnetic fields, direct sunlight, drafts, excessive moisture or large temperature fluctuations.

Position the HCS Automated Plate Washer with a minimum of 20 cm (8 inches) between the back panel assembly and walls or objects to service fuses and AC power cord. In case of an emergency or malfunction, power OFF the HCS Automated Plate Washer and unplug the power cord from the wall power outlet.

If the instrument is exposed to temperatures outside 10–40°C, allow the instrument to equilibrate sufficiently to operate within this range. Failure to do so may result in damage to the instrument.

## 2.4 Biological safety

### **WARNING** Hazardous substances



The products used with this instrument may contain hazardous substances. When working with chemicals, always wear a suitable lab coat, disposable gloves and protective goggles. For more information, please consult the appropriate safety data sheets (SDSs). These are available online in PDF format at [www.qiagen.com/safety](http://www.qiagen.com/safety) where you can find, view and print the SDS for each QIAGEN kit and kit component. For further information see the instructions for use that comes with the kit.









To dispose of the HCS Automated Plate Washer, follow all national, state and local health and safety regulation and laws for disposing of laboratory waste. For disposal of Waste Electrical and Electronic Equipment (WEEE compliance), see “Appendix A – Waste Electrical and Electronic Equipment (WEEE),” page 52.







## 2.5 Waste disposal

Waste may contain certain hazardous chemicals or contagious/biohazardous materials and must be collected and disposed of properly in accordance with all national, state and local health and safety regulations and laws.

## 2.6 Symbols

The following symbols may be found on the instrument, in this user manual or on labels associated with the instrument.

Symbol	Location	Description
	On the instrument	Warning, dangerous voltage
	On the instrument	General warning sign
	On the instrument	Warning, biological hazard
	Type plate on the instrument	CE mark for Europe
	Type plate on the instrument	In vitro diagnostic medical device
	Type plate on the instrument	RoHS mark for China (the restriction of the use of certain hazardous substances in electrical and electronic equipment)
 	Type plate on the instrument	Waste Electrical and Electronic Equipment (WEEE)

Symbol	Location	Description
	Type plate on the instrument	Manufacturer
	Type plate on the instrument	Global Trade Item Number
	On the instrument	Serial number
	Instrument box label	Consult instructions for use
	Instrument box label	Fragile, handle with care
	In this user manual	Authorized representative in the European Community
	In this user manual	Catalog number

---

## 3 Unpacking

Save all packaging material in case it becomes necessary to return the instrument.

1. Place the shipping carton on the floor for easy access and removal of equipment.
2. Remove the reservoir kit using the pull handle.
3. Remove the accessories and AC power cord from the box.
4. Remove the foam cushions from the sides of the instrument.

**Important:** Do not lift the instrument by holding the syringe assembly on the back of the instrument.

5. Place hands under the front and rear side of the instrument and pull up to remove the instrument from the carton.
6. Refer to the shipping checklist below to verify that all items on the list have been received.
  - HCS Automated Plate Washer
  - 8-port manifold including needle cleaning wire
  - Reservoir kit
  - Region-specific AC power cord
  - Bag containing spare fuses and microwell strips
  - One white, 96-well microplate
  - Dust cover
7. Inspect all components for shipping damage. In case of damage, or if any items are missing, contact your local QIAGEN representative or QIAGEN Technical Services.

## 4 Installation

### 4.1 Selecting the AC line voltage

The HCS Automated Plate Washer is supplied with the correct voltage setting appropriate to the customer's country. Before operating the instrument, make sure that the setting is correct by inspecting the fuse module. If unsure of the correct voltage setting, contact your local power company.

The fuse module is installed in the Power Entry Module (PEM) located on the back of the instrument. The fuse module of the HCS Automated Plate Washer has 2 different fuses:

- A larger 375 mA fuse required for 110–120 volt use
- A smaller 160 mA fuse required for 220–240 volt use

#### **WARNING** Risk of personal injury



Disconnect the power cord from the wall power outlet before installing the fuse module and Power Entry Module.

To remove the fuse module, pry it open at the slot in the top middle with a small screwdriver and slide outwards (see "Installing fuses," page 39)

#### 4.1.1 120 line voltage selection

The small arrow below the selected "110–120V" voltages shown on the fuse module must align with the white arrow on the PEM for proper operation.

**Note:** This is the correct orientation of the fuse module in the PEM for operation in the voltage of 99 to 132 volts.

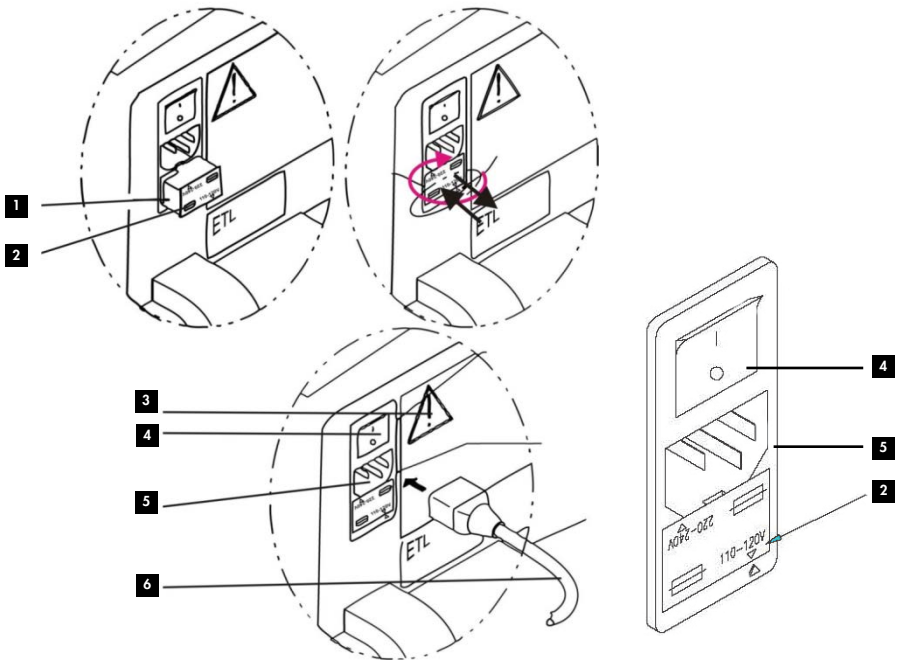

- |  |  |
|--|--|
| <b>1</b> Fuse module   | <b>4</b> Switch in <b>OFF</b> position |
| <b>2</b> Voltage: 110–120 V or 220–240 V<br>Installation shown for 110–120 V | <b>5</b> Power Entry Module            |
| <b>3</b> Safety warning  | <b>6</b> Power supply cable            |

#### 4.1.2 220 line voltage selection

The small arrow below the selected “220–240V” voltages shown on the fuse module must align with the white arrow on the PEM for proper operation.

**Note:** This is the correct orientation of the fuse module in the PEM for operation in the voltage of 198 to 264 volts.



## 4.2 Manifold installation

The manifold connectors are color-coded to assist in correctly connecting the manifold to the washer tubing.

### **CAUTION**    **Damage to the instrument**



Handle the manifold carefully. The dispense and aspirate needles on the manifold are fragile.

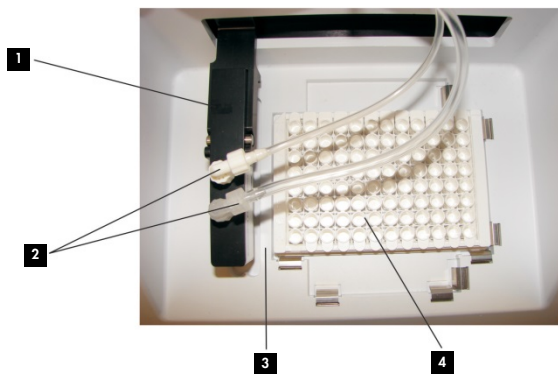

**1** Manifold

**2** White and clear fittings at correct angle

**3** Clear microwell strip

**4** Microplate

8. With the label facing forward, place the manifold in the harness cradle by inserting the side pins into the brackets.
9. Connect the white fitting to the white connector and connect the clear fitting to the clear connector.

**Important:** The washer tubing must be connected correctly for proper functioning of the manifold.

**Important:** Do not over-tighten the fittings.

10. Hand-tighten the fittings by turning clockwise.
11. Align the tubing from the manifold slightly backward at about a 45 degree angle.

**CAUTION**    **Damage to the instrument**



The clear microwell strip must be properly seated in the position nearest the microplate to prevent damage to the aspirate and dispense needles.

12. Place a clear microwell strip into the slot nearest to the plate.

### 4.3 Setting up the reservoirs

Prior to operating the HCS Automated Plate Washer, the reservoirs must be connected properly. The tubing connectors are color-coded to assist in correctly connecting the instrument to the reservoirs. The following graphics provide a visual aid to setting up the reservoirs properly.

**CAUTION**    **Damage to the instrument**



Do not over-tighten the fittings.

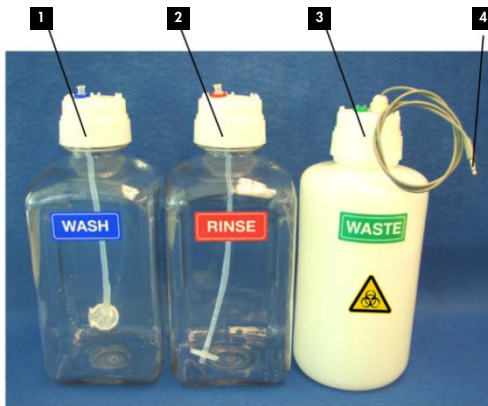

- 1** Wash bottle with blue fitting
- 2** Rinse bottle with red fitting
- 3** Waste bottle with green fittings
- 4** Waste bottle sensor connector

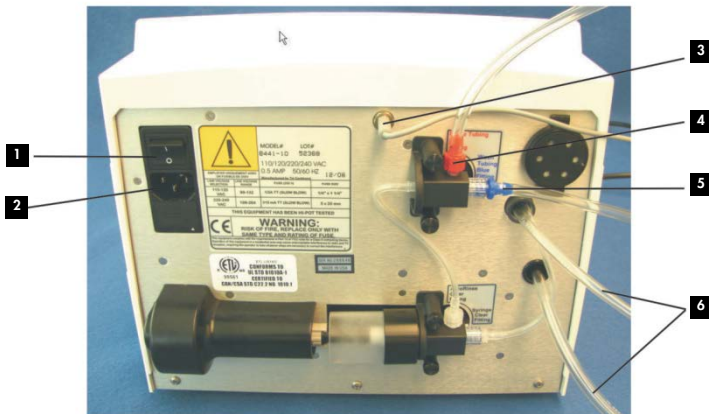

- 1** Power switch
- 2** Power cord connection
- 3** Waste bottle sensor connection (gray)
- 4** Rinse bottle connection (red)
- 5** Wash bottle connection (blue)
- 6** Tubing to vacuum pump

1. Fill the rinse reservoir with deionized or distilled water.
2. Fill the wash reservoir with wash buffer.  
**Note:** Refer to the respective *digene* HC2 DNA test instructions for use for instructions on preparing the wash buffer.
3. Place the wash, rinse and waste reservoirs behind the HCS Automated Plate Washer.
4. Make sure the cap on the waste reservoir is tight to prevent vacuum leaks.
5. Insert the 2 green fittings into the 2 green grommets on the waste reservoir cap.  
**Note:** It does not matter which green fitting goes into which green grommet.
6. Push the green fittings in until they are fully seated in the green grommets.
7. Insert the blue fitting into the wash reservoir cap.
8. Insert the red fitting into the rinse reservoir cap.
9. Connect the blue Luer fitting of the wash tubing to the connector on the back of the instrument labeled "Wash Tubing Blue Fitting". Refer to the illustration, above, for the location.
10. Hand-tighten the blue Luer fitting by turning clockwise.
11. Connect the red Luer fitting of the rinse tubing to the connector on the back of the instrument labeled "Rinse Tubing Red Fitting". Refer to the illustration, above, for the location.
12. Hand-tighten the red Luer fitting by turning clockwise.
13. Connect the waste bottle sensor plug into the connection on the back of the instrument. Refer to the illustration, above, for the location.
14. Insert the power cord into the power cord connection on the back panel.

## 5 Functional Description

The HCS Automated Plate Washer is a self-contained microplate washer utilizing a positive-displacement pump to assure accurate, consistent plate washing.

The following figure shows the major external components of the instrument.



**1** Reservoir bottles

**2** Manifold

**3** Plate

**4** Keypad and display

## 5.1 Keypad and display

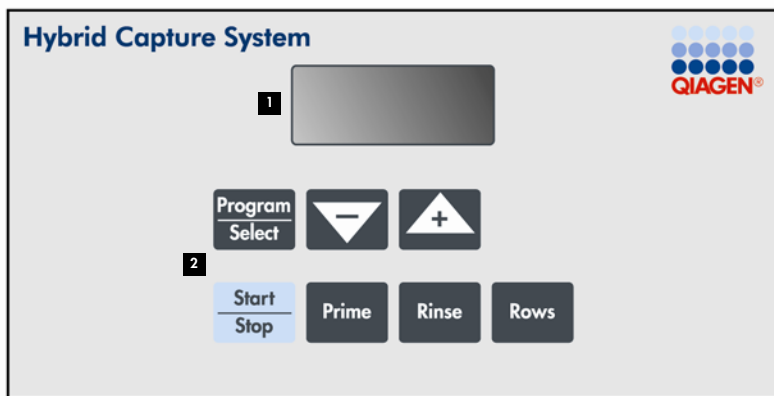

The operating controls for the HCS Automated Plate Washer are on the front panel. The following figure shows the keypad and display on the front panel.







1 Display

2 Keypad

The keypad has 7 keys:

Key	Function
	Selects between programs. <b>Note:</b> This button is not used as there is currently only one wash program.
	Starts a wash cycle or stops a wash cycle in progress.
	Runs the <b>Prime</b> cycle.

<b>Key</b>	<b>Function</b>
	Runs the <b>Rinse</b> cycle.
	Used to enter or change the number of rows to be washed.
	Decreases the number of rows to be washed.
	Increases the number of rows to be washed.

The display of the HCS Automated Plate Washer indicates the current setting of selected parameters and indicates status when a wash is in progress.

<b>Display</b>	<b>Description</b>
<b>Pri</b>	The instrument is completing the prime routine.
<b>rin</b>	The instrument is completing the rinse routine.
<b>run</b>	The instrument is completing the wash cycle.
<b>P1</b>	The wash cycle is complete.
<b>FUL</b>	The waste reservoir is full.

---

## 5.2 Positive-displacement pump

Wash buffer is dispensed by an accurate, reliable, positive-displacement pump. The dispense cycle begins when a valve on the syringe assembly opens the port to the wash buffer reservoir and the pump moves in the fill direction to draw wash buffer into the syringe. When the syringe is full, the valve moves to the dispense position.

The pump dispenses the volume of wash buffer into the microplate wells. During the wash cycle, the valve and syringe operate under program control to maintain adequate wash buffer in the pump. Wash buffer flows through flexible tubing from the syringe into the manifold dispense needles to the microplate wells.

## 5.3 Air pump and aspirate needles

Waste is aspirated from the microplate wells using the air pump and aspirate needles.

The air pump maintains a vacuum in the waste reservoir and this is connected by flexible tubing to the aspirate needles in the manifold. As the manifold is lowered over the microplate, liquid in the microplate wells is aspirated by the vacuum, and the waste is emptied into the waste reservoir. The rate of aspiration is such that only the tips of the aspirate needles make contact with the liquid and carryover from row to row is minimized.

## 5.4 Waste reservoir

A liquid-level sensor in the waste reservoir signals when the waste reservoir is nearly full. When liquid has reached the liquid-level sensor, the waste reservoir must be emptied before the HCS Automated Plate Washer will begin a new wash cycle. The HCS Automated Plate Washer will display **FUL** and will not run until the waste reservoir is emptied.



## 6 General Operation

The HCS Automated Plate Washer is a self-contained microplate washer. Make sure to perform the required functional verification procedure, below, before operating the HCS Automated Plate Washer for the first time.

### 6.1 Functional verification

1. Power ON the instrument.
2. Place a clear microwell strip and microplate onto the HCS Automated Plate Washer.
3. Make sure that the manifold is sitting level (front to back) in its cradle.
4. Press **Rinse** and visually verify the liquid leaves the rinse reservoir and is dispensed into the clear microwell strip.

When the function is complete, **P1** displays.

5. Press **Prime** and visually verify the liquid leaves the wash reservoir and is dispensed into the clear microwell strip.

When the function is complete, **P1** displays.

6. Press **Rows** to verify that the default is set to **12** to correspond to 12 rows on the plate.
7. Press **Start/Stop**.

A wash cycle begins.

8. Verify that the HCS Automated Plate Washer performs 2 bottom wash cycles followed by 4 full-height wash cycles.

All wells should be equivalent and not overflow. The instrument should automatically perform a maintenance rinse cycle after completion of the wash program. During the 2 bottom wash cycles, the microplate wells are partially filled. During the 4 full-height washes, the microplate wells are overfilled to form a rounded reverse meniscus.

If functional verification fails, see "Troubleshooting," page 43, for additional instructions.

---

## 6.2 Maintenance rinse function

**Important:** Leave the instrument powered ON at all times so the rinse function is performed every 8 hours.

To maintain reliability, the instrument performs a rinse cycle every 8 hours while not in use and powered ON. The rinse cycle protects the manifold needles from drying out and prevents the wash buffer from causing salt deposits to clog the instrument due to evaporation. Make sure the rinse reservoir is filled with enough deionized or distilled water for the rinse cycle to occur every 8 hours. A full rinse reservoir contains enough liquid for 2 weeks of operation.

If the HCS Automated Plate Washer is not required for a period of time greater than 2 weeks, see "Powering OFF," page 28, for instructions on powering OFF the instrument.

## 6.3 Prime cycle

Priming fills the syringe pump, lines and manifold with wash buffer.

Perform the prime cycle after:

- The instrument is set up
- The reservoirs are filled or changed
- The manifold is changed

1. Press **Prime** to initiate the prime cycle.

During the prime cycle the display will show **Pri**.

2. Press **Start/Stop** to cancel the prime cycle.

---

## 6.4 Rinse cycle

The rinse cycle uses deionized or distilled water to purge the syringe, tubing and manifold of wash buffer.

1. Press **Rinse** to initiate the rinse cycle  
During the rinse cycle, the display will show **rin**.
2. Press **Start/Stop** to cancel the rinse cycle.

## 6.5 Wash cycle

A prime cycle precedes each wash cycle, and a rinse cycle automatically starts approximately 2 seconds after the wash cycle ends.

1. Press **Rows** to enter the number of rows to wash.
2. Select the number of rows (**1–12**) with the **(-)** and **(+)** arrow keys.
3. Press **Rows** to exit the row selection.
4. Press **Start/Stop** to begin washing the plate.  
During the wash cycle, the display will show **run**.
5. Press **Start/Stop** a second time to cancel a wash cycle.  
If the wash cycle was canceled, press **Start/Stop** a third time to return the manifold to the standby row.

---

## 6.6 Emptying the waste reservoir

When the liquid in the waste reservoir covers the end of the sensor probe, the instrument will beep and display **FUL** when **Start/Stop** is pressed to begin a wash cycle. The waste reservoir must be emptied before the wash cycle will begin.

1. Remove the lid of the waste reservoir.
2. Empty the waste reservoir.
3. Replace the lid of the waste reservoir.
4. Make sure the cap on the waste reservoir is tight to prevent vacuum leaks.
5. Press the **Start/Stop** key to begin a wash cycle.

## 6.7 Powering OFF

If powering OFF the HCS Automated Plate Washer, the wash buffer must be completely removed from the instrument to prevent damage.

1. Remove the lids of the rinse and wash reservoirs.
2. Empty the rinse and wash reservoirs.
3. Rinse the rinse and wash reservoirs with deionized or distilled water.
4. Fill the rinse and wash reservoirs with distilled or deionized water.
5. Replace the lids of the rinse and wash reservoirs.
6. Press the **Prime** key.  
The prime cycle begins.
7. Press the **Rinse** key.  
The rinse cycle begins.
8. Repeat the prime and rinse cycles.
9. Power OFF the instrument.

---

# 7 Maintenance

Perform maintenance as described in this section. QIAGEN charges for repairs that are required due to incorrect maintenance.

The user is responsible for carrying out appropriate decontamination if hazardous materials are spilled on or inside the instrument.

Clean the outside of the instrument with a mild detergent.

**Note:** Before using any cleaning or decontamination method, except those recommended in this user manual, check with your local QIAGEN representative or QIAGEN Technical Services to ensure that the proposed method will not damage the equipment.

Maintain your instrument in good working order. In the event that the instrument has been subject to adverse conditions (such as fire, flood, earthquake, etc.), perform a service inspection to ensure safe operation.

## 7.1 Monthly maintenance

### 7.1.1 Cleaning

Clean the tubing, rinse reservoir and wash reservoir with a 0.5% sodium hypochlorite solution (bleach) and rinse thoroughly with deionized or distilled water once a month. Cleaning monthly prevents contamination from alkaline phosphatase.

---

Wear disposable powder-free gloves, safety glasses and a lab coat while performing this procedure.

1. Prepare about 1 liter of a 0.5% sodium hypochlorite solution.

**Note:** Industrial bleach contains 10% sodium hypochlorite. To dilute industrial bleach, prepare a 20:1 mixture. Household bleach contains 5% sodium hypochlorite. To dilute household bleach, prepare a 10:1 mixture.

2. Clean all outside surfaces of the HCS Automated Plate Washer with a low-lint paper towel wetted with the 0.5% sodium hypochlorite solution.

**Important:** Make sure not to get the solution inside the chassis.

3. Rinse with a low-lint paper towel wetted with deionized or distilled water.
4. Dry the surface with low-lint paper towels.
5. Empty the wash and rinse reservoirs.
6. Add about 500 ml of the 0.5% sodium hypochlorite solution into each reservoir.
7. Cap the reservoirs and shake to cover all internal surfaces of the reservoirs.
8. Perform a rinse cycle. Repeat to complete a total of 3 rinse cycles.  
See "Rinse cycle," page 27, for additional instructions.
9. Perform a prime cycle. Repeat to complete a total of 3 prime cycles.  
See "Prime cycle," page 26, for additional instructions.
10. Dispose of any remaining 0.5% sodium hypochlorite solution and completely rinse the rinse and wash reservoirs with deionized or distilled water.
11. Fill the rinse reservoir with deionized or distilled water and the wash reservoir with wash buffer.
12. Perform 3 rinse cycles followed by 3 prime cycles.

### 7.1.2 Flushing the reservoir tubing

The tubing in both the wash and rinse reservoirs must be flushed monthly. Flushing the tubing and filter removes trapped particles and prevents excessive pressure on the dispense pump and syringe assembly.

Perform this procedure while holding the cap, tubing and filter over a sink.

#### **CAUTION**    **Damage to the instrument**



To avoid contamination, be careful not to let the filter touch the sink.

1. Disconnect the blue and red tubing connectors from the rear of the instrument.
2. Aspirate approximately 10 ml of deionized or distilled water into either a 12.5 ml Eppendorf® Combitip® (cat. no. 226140-1) or a 10–25 ml syringe.
3. Insert Combitip or syringe into the blue wash tubing fitting.
4. Unscrew the bottle cap with attached filter, being careful to handle by the cap only.
5. Dispense deionized or distilled water into the fitting and through the tubing to flush the filter.
6. Remove the Combitip or syringe.
7. Aspirate air into the Combitip or syringe and repeat the flush to dispense air into the tubing.
8. Repeat steps 2–7 for the red rinse tubing fitting.
9. Reconnect the blue and red tubing connectors to the rear of the instrument.
10. Refill both tubes by pressing **Prime** and then **Rinse**.

### 7.1.3 Replacing aspirate exhaust filter

The exhaust filter material consists of 2 ordinary cotton balls. Replace the cotton balls monthly by removing the exhaust cap on the rear panel of the instrument, replacing the old cotton balls with new cotton balls and returning the exhaust cap filter. Refer to the graphic below as a visual aid.

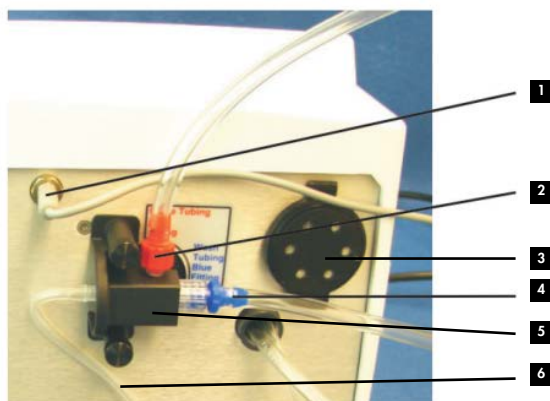

- |  |  |
|--|--|
| <b>1</b> Waste bottle sensor connection (gray) | <b>4</b> Wash bottle connection (blue) |
| <b>2</b> Rinse bottle connection (red)         | <b>5</b> Autorinse valve and cover     |
| <b>3</b> Exhaust filter                        | <b>6</b> Autorinse tubing              |

## 7.2 Cleaning manifold needles

A needle cleaning wire is supplied with each manifold and is used to clear aspirate or dispense needles clogged by particulates or dried salt deposits when rinsing fails to clear a bore.

The needles are made of stainless steel. The manifold tips are a coaxial design with the center tube dispensing liquid and the outer tube aspirating liquid.



**CAUTION**    **Damage to the instrument**



Take care to prevent bending the precision stainless steel tips.

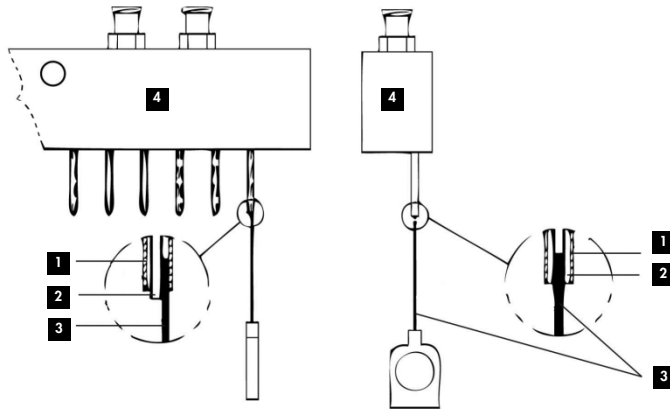

- 1** Aspirate needle
- 2** Dispense needle

- 3** Cleaning wire
- 4** Manifold

1. Release the manifold.
2. Clean the dispense needles. Avoid bending the assembly.
3. Replace the manifold.
4. Follow the cleaning procedure before starting a new wash cycle.  
See "Cleaning," page 29, for additional instructions.

## 7.3 Installing manifold tubing

Install the manifold tubing as needed if the tubing becomes worn, dry or cracked. The Replacement Tubing Kit is required to perform this procedure.

### **CAUTION**    **Damage to the instrument**



The dispense and aspirate needles on the manifold are fragile.

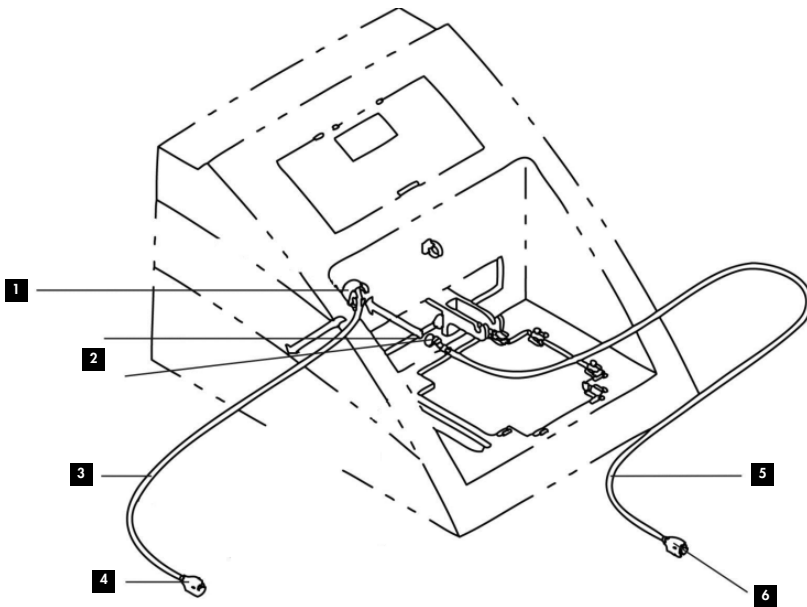

**1** Conduit

**2** White fitting

**3** Waste/manifold assembly (clear)

**4** Clear fitting

**5** Syringe/manifold assembly (white)

**6** White fitting

Follow these instructions to install new tubing:

1. Identify and remove existing tubing to be replaced.
2. Prepare new tubing for the waste/manifold assembly (clear fitting) and syringe/manifold assembly (white fitting).
3. Thread the clear fitting on clear tubing assembly through the conduit from the rear of the instrument.
4. Thread the white fitting on white tubing assembly through the conduit from the front of the instrument.
5. Turn the conduit so the tubing relief slot is at the right side when viewed from the front of the case.

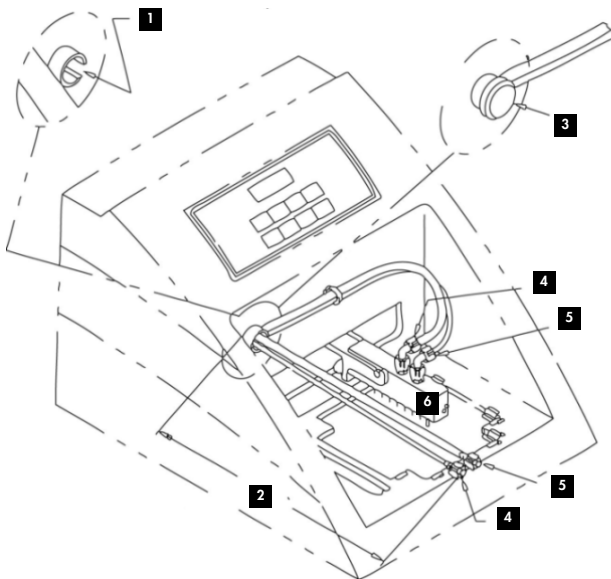

- |   |                        |
|---|------------------------|
| <b>1</b> Slot in conduit on right side    | <b>4</b> White fitting |
| <b>2</b> 27 cm (10.5) inches of tubing    | <b>5</b> Clear fitting |
| <b>3</b> Black cap installed over conduit | <b>6</b> Manifold      |

- 
6. Measure 27 cm (10.5 inches) of tubing from the front of the case to the end of the Luer fitting.
  7. Install the black cap to close off the front end of the conduit.
  8. Thread both Luer fittings through the tubing clip.
  9. Perform the cleaning procedure before starting a new wash cycle.  
See "Cleaning," page 29, for additional instructions

## 7.4 Cleaning reagent spills

If the Detection Reagent 1 from a *digene* HC2 DNA kit spills on or near the instrument, follow the procedure in "Cleaning," page 29.

## 7.5 Repositioning the syringe plunger

The syringe plunger becomes disconnected when it cannot move. This can be caused by kinked tubing, clogged tubing or a clogged valve. The following procedure disconnects the syringe and repositions it to allow the syringe plunger to move.

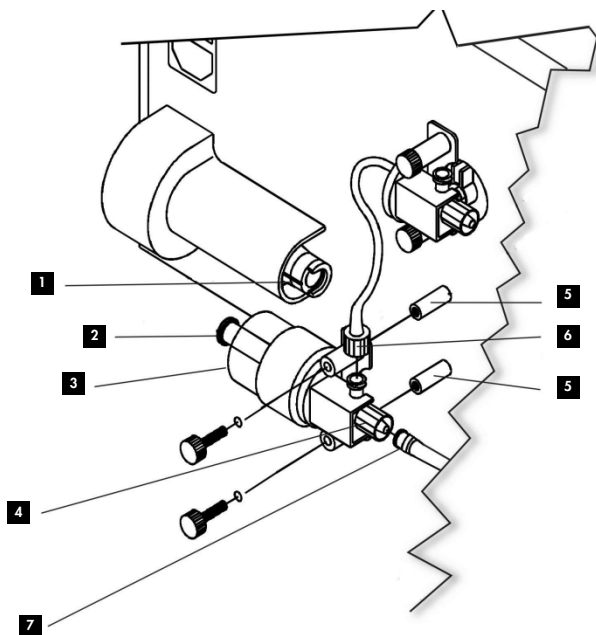

- |   |  |
|---|--|
| <b>1</b> Follower groove                    | <b>4</b> Valve nut                     |
| <b>2</b> Syringe plunger (black color part) | <b>5</b> Studs                         |
| <b>3</b> Syringe assembly                   | <b>6</b> Tube nut from autorinse valve |
|   | <b>7</b> Fitting                       |

1. Remove the tube nut from the autorinse valve.
2. Remove the fitting from the valve nut and release the studs.
3. Reposition the syringe plunger into the follower groove.

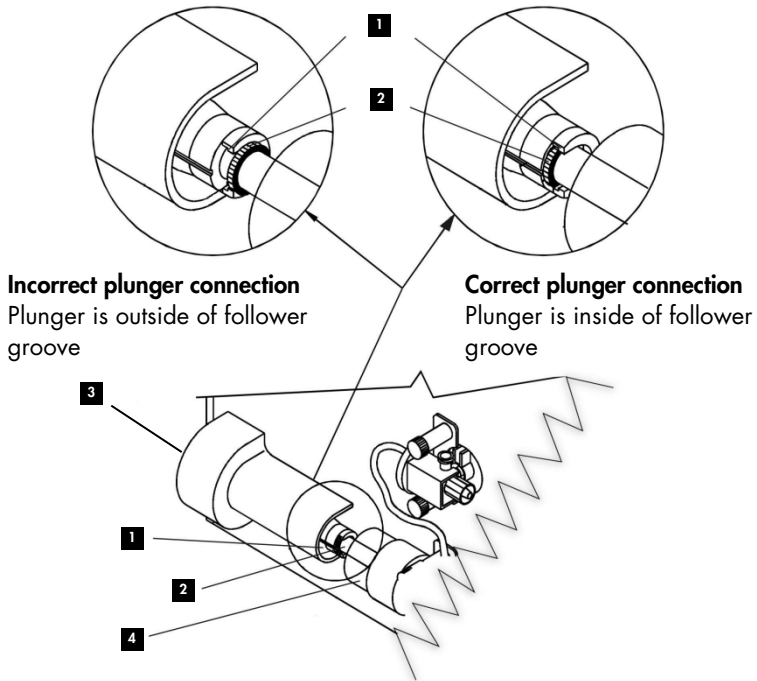

- |                          |                                     |
|--------------------------|-------------------------------------|
| <b>1</b> Follower groove | <b>3</b> Stepper motor nut location |
| <b>2</b> Syringe plunger | <b>4</b> Syringe                    |

4. Reinstall the syringe onto the studs, making sure that the syringe plunger is fully engaged into the follower groove.
5. Reconnect the tube nut to the autorinse valve.
6. Reinstall the valve nut.

## 7.6 Installing fuses

Fuses are installed if the input voltage is changed or if a fuse is blown.

**Important:** For proper operation, install both types of fuses.

### **WARNING** Risk of personal injury



Disconnect the power cord from the wall power outlet before removing the fuse module.

1. Power OFF the instrument and unplug the power cord.
2. Remove the fuse drawer using a small screwdriver, or equivalent tool, by prying at the slot at the top middle of the fuse drawer as shown below.

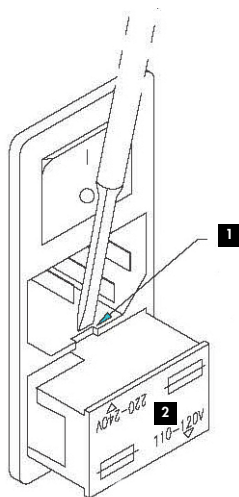

**1** Opening slot for fuse drawer

**2** Fuse drawer

3. Place the fuse drawer on the bench.
4. Install a 375 mA fuse for 110–120 volts into the fuse clips on the correct side of the fuse drawer as labeled.
5. Install a 160 mA fuse for 220–240 volts into the fuse clips on the correct side of the fuse drawer as labeled.

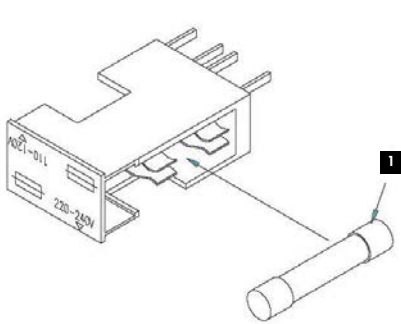

**1** 375 mA fuse for 110–120 V

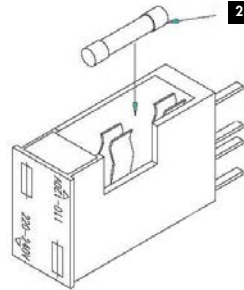

**2** 160 mA fuse for 220–240 V

6. Install the fuse drawer as required for the supplied power.  
See “Selecting the AC line voltage,” page 15, for additional instructions.

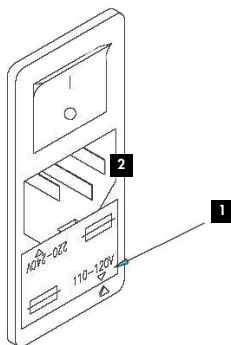

**1** Voltage: 110–120 V or 220–240 V  
Installation shown for 110–120 V

**2** Power Entry Module



---

## 7.7 Repair

Do not ship the instrument back for repair until advised to do so by your local QIAGEN representative or QIAGEN Technical Services.

Do not attempt to repair the instrument; removing the case will nullify the warranty. In the event that the product is inoperable, contact your local QIAGEN representative and provide complete details about the operational failures. When describing the performance of the instrument, please have the serial number of the HCS Automated Plate Washer.

In the event that you are requested to return the instrument or any part thereof, it is your obligation to fully decontaminate the instrument. Your local QIAGEN representative or QIAGEN Technical Services may request a certificate to verify decontamination is included with the returned instrument. Failure to do this may result in refusal to repair the instrument. Contact your local QIAGEN representative or QIAGEN Technical Services for a return goods authorization (RGA) number. Write this number on the outside of the shipping box.

## 7.8 Decontamination before shipping

Any laboratory equipment that has been used for research or clinical analysis is considered a potential biohazard and requires decontamination before servicing or shipping. Wear powder-free gloves when handling potentially contaminated equipment.

To decontaminate the HCS Automated Plate Washer, follow the cleaning procedure (see "Cleaning," page 29).

## 7.9 Maintenance schedule

Model \_\_\_\_\_ Serial number \_\_\_\_\_ Institution \_\_\_\_\_

Date	Start of day			End of day		Monthly		
	Fill wash reservoir	Perform prime cycle	Check needles (clean if required)	Fill rinse reservoir	Perform rinse cycle	Flush, wash and rinse reservoir tubing	Clean	Replace exhaust filter
1								
2								
3								
4								
5								
6								
7								
8								
9								
10								
11								
12								
13								
14								
15								
16								
17								
18								
19								
20								
21								
22								
23								
24								
25								
26								
27								
28								
29								
30								
31								

## 8 Troubleshooting

Refer to this section to resolve equipment operation problems. If the recommended steps do not resolve the problem, contact QIAGEN Technical Services for assistance.

### Possible problem or cause

### Corrective action

---

#### **The display is blank, the beeper does not sound when keys are pressed and the motors do not operate**

- |  |  |
|--|--|
| a) The power cord is not plugged in properly | Make sure that the power cord is plugged into a known, working power source. |
| b) The power source is not functioning       | Make sure the power source has power and correct as necessary.               |
| c) The fuse has blown                        | Replace the fuse. See "Installing fuses," page 39.                           |

#### **The instrument is not responding to key presses**

- |  |  |
|--|--|
| Invalid data in the instrument's stored programs | Power OFF the instrument, wait 5 seconds and then power ON the instrument to clear any possible electronic memory conflicts. |
|--|--|

---

**Possible problem or cause****Corrective action**

---

**The manifold hits the microplate when aspirating rows**

The manifold is not calibrated to the proper position within the microplate wells

Contact your local QIAGEN representative or QIAGEN Technical Services.

**The instrument aspirates wells partially or not at all**

a) The manifold aspirate needles are partially or completely clogged

Clean needles with supplied tool (see "Cleaning manifold needles," page 32).

b) The tubing is kinked, obstructed, too short or not connected properly

Check tubing and connections.  
Replace worn tubing. See "Installing manifold tubing," page 34, for additional instructions.

c) The waste reservoir cap is loose or the fittings on the cap are loose

Tighten the cap of the waste reservoir; check all fittings for tightness of fit.

**The instrument dispenses partially or not at all**

a) The manifold dispense needles are clogged

Clean needles with the supplied tool (see "Cleaning manifold needles," page 32).

Possible problem or cause	Corrective action
b) The wash reservoir filter is clogged	Flush the filter (see “Flushing the reservoir tubing,” page 31) or replace the filter.
c) The tubing is kinked, obstructed, too short or not connected properly	Check tubing and connections. Replace worn tubing. See “Installing manifold tubing,” page 34, for additional instructions.

### The instrument overfills wells

a) The dispense or aspirate needles are clogged	Clean the manifold needles with the supplied tool (see “Cleaning manifold needles,” page 32).
b) The aspiration pump or waste reservoir tubing is kinked, obstructed or not connected properly	Check tubing and connections. Replace worn tubing. See “Installing manifold tubing,” page 34, for additional instructions.
c) The waste reservoir cap is loose or the fittings on the cap are loose	Tighten the cap on the waste reservoir and check all fittings for tight fit.
d) The manifold needles are not parallel to the well strips	Adjust the manifold so that it is level. Make sure all well strips are securely locked into the microplate rack.

---

**Possible problem or cause****Corrective action**

---

- |  |  |
|--|--|
| e) The aspirate and dispense tubing connections to the manifold reversed | Make sure the clear fittings are attached to the clear connections and the white fittings are attached to the white connections. |
|--|--|

**Waste reservoir sensor does not register FUL when submerged in liquid.**

- |   |  |
|---|--|
| Accumulated residue is preventing the float switch from functioning | Wipe the residue off the white float switch located on the probe attached to the inside of the cap of the waste reservoir. |
|---|--|

**Waste bottle has collapsed**

- |  |   |
|--|---|
| The aspirate needles in the manifold are clogged or the tubing is kinked | Clean the manifold needles with the supplied tool (see "Cleaning manifold needles," page 32).<br><br>Check tubing and straighten kinks. |
|--|---|

**Grinding noise from the back of the instrument and no fluid movement**

- |  |   |
|--|---|
| a) The syringe plunger is immobilized due to dried wash buffer | Power OFF the instrument. Using a large standard screw driver, turn the stepper motor nut (see page 38) counter-clockwise 5 turns. Power ON the instrument and run 3 rinse cycles (see "Rinse cycle," page 27). |
|--|---|

---

**Possible problem or cause****Corrective action**

---

- b) The syringe plunger is outside of the follower groove
- Reposition the syringe plunger. See "Repositioning the syringe plunger," page 37, for additional instructions.

**The syringe plunger pops out of the follower groove**

- a) The tubing from the wash or rinse reservoirs is kinked or blocked
- Clear the tubing of all obstructions.  
Reposition the syringe plunger. See "Repositioning the syringe plunger," page 37, for additional instructions.
- b) The wash or rinse reservoir filter is clogged
- Flush the filter or replace the filter. See "Flushing the reservoir tubing," page 31, for additional instructions.
- c) The syringe assembly needs to be replaced
- Contact your local QIAGEN representative or QIAGEN Technical Services.

**Possible problem or cause**

**Corrective action**

---

**High background or false-positive results in the respective *digene* HC2 DNA test**

- |   |  |
|---|--|
| a) Alkaline phosphatase contamination of the HCS Automated Plate Washer | Clean the wash and rinse bottles. See “Cleaning,” page 29, for additional instructions.  |
| b) Bacterial or fungal contamination                                    | Make sure that the wash and rinse reservoirs are free from bacterial or fungal contamination.<br><br>Replace the wash buffer and deionized or distilled water in the reservoirs. |



# 9 Technical Data

## 9.1 Operating conditions

<b>Condition</b>	<b>Parameter</b>
Dimensions (w x d x h)	242 x 280 x 369 mm (9.5 x 11 x 14.5 inches)
Weight	5.4 kg (12 lbs)
Power requirements for 6000-00174	110–120 Volts AC, 60Hz
Power requirements for 6000-00175	220–240 Volts AC, 50Hz
Transient overvoltage	Not to exceed 10% of nominal voltage(s)
Power consumption	30 watts maximum
Air temperature	10–40°C
Place of operation	For indoor use only
Pollution level	II
Altitude	Up to 2000 meters (6500 feet)

<b>Condition</b>	<b>Parameter</b>
Wash, rinse and waste reservoir capacity	2 liters each
Residual volume	Less than 7 $\mu$ l per well
Accuracy at 300 $\mu$ l	< $\pm$ 5%
Liquid contact materials	Glass, nylon, stainless steel, polypropylene Tygon <sup>®</sup> , Teflon <sup>®</sup> , Delrin <sup>®</sup> , Santoprene <sup>™</sup> , polyethylene

## 9.2 Transport conditions

<b>Condition</b>	<b>Parameter</b>
Air temperature	1–40°C in manufacturer's package
Weight	11.3 kg (25 lbs) shipping weight

## 9.3 Storage conditions

<b>Condition</b>	<b>Parameter</b>
Air temperature	1–40°C in manufacturer's package

## 10 Ordering Information

Product	Contents	Cat. no.
Hybrid Capture System Automated Plate Washer	96-well microplate washer, 120 V	6000-00174
Hybrid Capture System Automated Plate Washer	96-well microplate washer, 240 V	6000-00175
<b>Accessories and replacement parts</b>		
Reservoir Kit	Waste reservoir, rinse reservoir, wash reservoir, caps with tubing, slip connector, fittings	6000-00176
Replacement Syringe Assembly	Syringe assembly, valve, valve cover	6000-00177
Maintenance Kit	2 needle cleaning wires, 2 filters, valve cover, 4 fuses, 2 reservoir filters, 4 clear microplate strips	6000-00178
Wash Reservoir Cap Assembly	Wash reservoir cap, fittings	6000-00179
Rinse Reservoir Cap Assembly	Rinse reservoir cap, fittings	6000-00180
Waste Reservoir Cap and Bottle	Waste reservoir and cap, fittings	6000-3120
Replacement Tubing Kit	Replacement tubing, fittings	6000-00181
Replacement Manifold	Replacement manifold, fittings	6000-00183

For up-to-date licensing information and product-specific disclaimers, see the respective QIAGEN handbook or user manual. QIAGEN kit handbooks and user manuals are available at [www.qiagen.com](http://www.qiagen.com) or can be requested from QIAGEN Technical Services or your local distributor.

---

## Appendix A – Waste Electrical and Electronic Equipment (WEEE)

This section provides information about disposal of waste electrical and electronic equipment by users.

The following crossed-out wheeled bin symbol (see below) indicates that this product must not be disposed of with other waste; it must be taken to an approved treatment facility or to a designated collection point for recycling, according to local laws and regulations.



Separate collection and recycling of waste electronic equipment at the time of disposal helps to conserve natural resources and make sure that the product is recycled in a manner that protects human health and the environment.

QIAGEN provides recycling upon request at additional cost. To recycle electronic equipment, you should contact your local QIAGEN sales office for the required return form. After you submit the form, QIAGEN will contact you either to request follow-up information for scheduling the collection of your electronic waste or to provide you with an individual quote.

---

## Appendix B – Warranty

The HCS Automated Plate Washer is warranted against defects in materials and workmanship for a period of one year from the date it is shipped from the manufacturer. If notified of such defects during the warranty period, the manufacturer will, at its option, either repair or replace products that prove to be defective.

The warranty shall not apply to defects resulting from improper or inadequate maintenance by the customer, unauthorized modification or service, misuse, operation outside of the environmental specifications for the product or instruments returned with inadequate packaging.

---

This page intentionally left blank

---

This page intentionally left blank

---

Ordering [www.qiagen.com/contact](http://www.qiagen.com/contact) | Technical Support [support.qiagen.com](http://support.qiagen.com) | Website [www.qiagen.com](http://www.qiagen.com)