

December 2020

QIAcube[®] Connect MDx User Manual

The QIAcube Connect MDx is intended for in vitro diagnostic use.



IVD

CE

REF



R1 MAT

9003070

QIAGEN GmbH, QIAGEN Strasse 1, D-40724 Hilden

1121932

Contents

1	Introduction	6
1.1	About this user manual	6
1.1.1	Technical assistance	6
1.1.2	Policy statement	7
1.2	Intended use of the QIAcube Connect MDx	7
1.3	Requirements for QIAcube Connect MDx users	7
1.4	Glossary	8
1.5	Accessories	8
2	Safety Information	9
2.1	Proper use	9
2.2	Electrical safety	11
2.3	Environment	12
2.4	Biological safety	13
2.5	Chemicals	14
2.6	Waste disposal	15
2.7	Mechanical hazards	15
2.7.1	Centrifuge	16
2.8	Heat hazard	17
2.9	Maintenance safety	17
2.10	Radiation safety	19
2.11	Symbols on the QIAcube Connect MDx	20
3	General Description	21
3.1	QIAcube Connect MDx principle	22
3.2	External features of the QIAcube Connect MDx	24
3.3	Internal features of the QIAcube Connect MDx	29
3.4	Disposables	36
4	Installation Procedures	38
4.1	Installation environment	38
4.1.1	Site requirements	38

4.1.2	Power requirements	39
4.1.3	Grounding requirements	40
4.2	Unpacking the QIAcube Connect MDx	40
4.3	Installing the QIAcube Connect MDx	41
4.3.1	Removal of the QIAcube Connect MDx accessories and shipping material	41
4.3.2	Installation of AC power cord	42
4.3.3	Installation of external barcode scanner	43
4.3.4	Installing the centrifuge rotor and buckets	43
4.3.5	Installing the shaker adapter	44
4.4	Configuration of the QIAcube Connect MDx	45
4.4.1	System configurations	46
4.4.2	Settings configuration	48
4.4.3	Network configuration	49
4.5	Packaging and transporting of the QIAcube Connect MDx	53
5	Operating Procedures	55
5.1	QIAcube Connect MDx software	58
5.2	Switching the QIAcube Connect MDx on and off	61
5.3	Logging in and Logging out	62
5.4	Setting up a protocol run	63
5.4.1	Material selection	67
5.4.2	Protocol selection	68
5.4.3	Parameter definition	69
5.4.4	Sample number definition	70
5.4.5	Loading buffer bottles	70
5.4.6	Loading tips and enzymes	73
5.4.7	Loading the centrifuge	75
5.4.8	Loading the shaker	82
5.5	Starting a protocol run	85
5.6	Stopping a protocol run	87
5.7	Saving run reports to the USB flash drive	88
5.8	Low space on flash memory	90

5.9	Independent heater/shaker operation	90
5.10	Independent centrifuge operation	92
5.11	Managing protocols	95
5.11.1	Installing new protocols	95
5.11.2	Deleting all protocols	96
5.11.3	Saving protocols	97
5.12	Updating software	98
5.13	User Management	100
5.13.1	Setting up a new user	101
5.13.2	Changing data for an existing user	103
5.13.3	Deleting or temporarily deactivating a user	104
5.13.4	Changing password	105
6	Cleaning and Maintenance	107
6.1	Cleaning agents	108
6.2	Disinfection	108
6.3	Regular maintenance	111
6.4	Daily maintenance	111
6.5	Monthly maintenance	113
6.6	Periodic maintenance	114
6.6.1	Cleaning the robotic arm modules	114
6.6.2	Cleaning the centrifuge	115
6.6.3	Operating the centrifuge after cleaning	120
6.7	Optional Maintenance	121
6.7.1	UV run	121
6.7.2	Tightness test	123
6.8	Decontaminating the QIAcube Connect MDx	124
6.9	Servicing	124
7	Troubleshooting	125
7.1	Contacting QIAGEN Technical Services	125
7.2	Creating a support package	125
7.3	Operation	126

	7.3.1	Protocol interruption	129
	7.3.2	Centrifuge.....	129
	7.3.3	Reagent volume detection and ultrasonic pipe	131
	7.3.4	Touchscreen	132
	7.3.5	O-Ring exchange.....	134
8		Glossary	140
9		Appendix A – Technical data	142
	9.1	Operating conditions.....	142
	9.2	Transport conditions.....	142
	9.3	Storage conditions	142
	9.4	Mechanical data and hardware features	143
	9.5	Declaration of Conformity	144
	9.6	Waste Electrical and Electronic Equipment (WEEE)	144
	9.7	EMC Declaration.....	145
	9.8	Liability Clause	146
10		Appendix B – QIAcube Connect MDx Accessories	148
11		Version history.....	151
Index			152

1 Introduction

Thank you for choosing the QIAcube Connect MDx. We are confident it will become an integral part of your laboratory. Before using the QIAcube Connect MDx, it is essential that you read this user manual carefully and pay attention to the safety information. The instructions and safety information in the user manual must be followed to ensure safe operation of the instrument and to maintain the instrument in a safe condition.

1.1 About this user manual

This user manual provides information about the QIAcube Connect MDx in the following sections:

1. Introduction
2. Safety Information
3. General Description
4. Installation Procedures
5. Operating Procedures
6. Cleaning and Maintenance
7. Troubleshooting
8. Glossary
9. Appendix A – Technical data
10. Appendix B – QIAcube Connect MDx Accessories
11. Version history

1.1.1 Technical assistance

At QIAGEN®, we pride ourselves on the quality and availability of our technical support. Our Technical Services Departments are staffed by experienced scientists with extensive practical and theoretical expertise in molecular biology and the use of QIAGEN products. If you have any questions or experience any difficulties regarding the QIAcube Connect MDx or QIAGEN products in general, do not hesitate to contact us.

QIAGEN customers are a major source of information regarding advanced or specialized uses of our products. This information is helpful to other scientists as well as to the researchers at QIAGEN. We therefore encourage you to contact us if you have any suggestions about product performance or new applications and techniques.

For technical assistance and more information, please see our Technical Support Center at www.qiagen.com/support/technical-support or call one of the QIAGEN Technical Service Departments or local distributors (see back cover or visit www.qiagen.com).

For up-to-date information about QIAcube Connect MDx instrument, visit <https://www.qiagen.com/products/qiacube-connect-mdx>.

1.1.2 Policy statement

It is the policy of QIAGEN to improve products as new techniques and components become available. QIAGEN reserves the right to change specifications at any time.

To produce useful and appropriate documentation, we appreciate your comments on this user manual. Please contact QIAGEN Technical Services.

1.2 Intended use of the QIAcube Connect MDx

QIAcube Connect MDx is designed to perform automated isolation and purification of nucleic acids in molecular diagnostic and/or molecular biology applications. The system is intended for use by professional users, such as technicians and physicians trained in molecular biological techniques and the operation of the QIAcube Connect MDx system.

The QIAcube Connect MDx is intended to be used only in combination with QIAGEN and PAXgene kits indicated for use with the QIAcube Connect MDx for the applications that will be described in the kit handbooks.

1.3 Requirements for QIAcube Connect MDx users

The table below covers the general level of competence and training necessary for transportation, installation, use, maintenance, and servicing of the QIAcube Connect MDx.

Task	Personnel	Training and experience
Delivery	No special requirements	No special requirements
Installation, routine use and maintenance	Laboratory technicians or equivalent	Appropriately trained and experienced personnel familiar with use of computers and automation in general
Servicing and annual maintenance	QIAGEN Field Service Specialists only	Trained and authorized by QIAGEN

1.4 Glossary

For a glossary of terms used in this User Manual, refer to Section 8.

1.5 Accessories

For information about QIAcube Connect MDx accessories, refer to Appendix B of this User Manual.

2 Safety Information

Before using the QIAcube Connect MDx, it is essential that you read this user manual carefully and pay attention to the safety information. The instructions and safety information in the user manual must be followed to ensure safe operation of the instrument and to maintain the instrument in a safe condition.

Possible hazards that could harm the user or result in damage to the instrument are clearly stated at the appropriate places throughout this consolidated operating guide.

If the equipment is used in a manner not specified by the manufacturer, the protection provided by the equipment may be impaired.

The following safety conventions appear throughout this manual:

WARNING 	The term WARNING is used to inform you about situations that could result in personal injury to you or other persons. Details about these circumstances are given in a box like this one.
--	--



CAUTION 	The term CAUTION is used to inform you about situations that could result in damage to the instrument or other equipment. Details about these circumstances are given in a box like this one.
---	--

The advice given in this manual is intended to supplement, not supersede, the normal safety requirements prevailing in the user's country.

2.1 Proper use

WARNING 	Risk of personal injury and material damage [W1] Improper use of the QIAcube Connect MDx may cause personal injuries or damage to the instrument. The QIAcube Connect MDx must only be operated by qualified personnel who have been appropriately trained. Servicing of the QIAcube Connect MDx must only be performed by a QIAGEN Field Service specialist.
---	--

Perform the maintenance as described in section 6, Maintenance Procedures. QIAGEN charges for repairs that are required due to incorrect maintenance.

WARNING 	Risk of personal injury and material damage [W2] The QIAcube Connect MDx is too heavy to be lifted by one person. To avoid personal injury or damage to the instrument, do not lift the instrument alone.
WARNING 	Risk of personal injury and material damage [W3] Do not attempt to move the QIAcube Connect MDx during operation.

CAUTION 	Damage to the instrument [C1] Avoid spilling water or chemicals onto the QIAcube Connect MDx. Damage caused by water or chemical spillage will void your warranty.
---	--

In case of emergency, power OFF the QIAcube Connect MDx at the power switch located in front of the instrument and unplug the power cord from the power outlet.

CAUTION 	Damage to the instrument [C2] Only use QIAGEN spin columns and QIAcube Connect MDx specific consumables with the QIAcube Connect MDx. Damage caused by use of other types of spin columns or chemistries will void your warranty.
--	---

WARNING 	Risk of personal injury and material damage [W4] Do not use damaged rotor adapters. The rotor adapters can only be used once. High g forces exerted in the centrifuge can cause damage to re-used rotor adapters.
---	---

CAUTION 	Damage to the instrument [C3] Empty the tip disposal container prior to use to prevent a tip jam in the waste drawer. Failure to empty the waste container may block the robotic arm that could cause run failure or instrument damage.
---	---

WARNING 	Risk of personal injury and material damage [W5] To prevent plastic crash, load the tubes properly. After a plastic crash, sharp plastic particles could be inside the centrifuge. Be careful when handling items inside the centrifuge.
---	--

CAUTION 	Damage to the instrument [C4] Only use the correct volume of liquids. Exceeding the recommended volume of liquids may damage the centrifuge rotor or instrument.
---	---

WARNING 	<p>Risk of fire or explosion [W6]</p> <p>When using ethanol or ethanol-based liquids on the QIAcube Connect MDx, handle such liquids carefully and in accordance with the required safety regulations. If liquid has been spilled, wipe it off and leave the QIAcube Connect MDx hood open to allow flammable vapors to disperse.</p>
---	---

WARNING 	<p>Risk of explosion [W7]</p> <p>The QIAcube Connect MDx is intended for use with reagents and substances supplied with QIAGEN kits or other than outlined in respective Information for use. Use of other reagents and substances may lead to fire or explosion.</p>
---	---

If hazardous material is spilled on or inside the QIAcube Connect MDx, the user is responsible for carrying out appropriate decontamination.

Note: Do not place items on top of the QIAcube Connect MDx hoods.

CAUTION 	<p>Damage to the instrument [C5]</p> <p>Do not lean against the touchscreen when it is pulled out.</p>
--	--

2.2 Electrical safety

Note: Disconnect the line power cord from the power outlet before servicing.

WARNING 	<p>Electrical hazard [W8]</p> <p>Any interruption of the protective conductor (earth/ground lead) inside or outside the instrument or disconnection of the protective conductor terminal is likely to make the instrument dangerous.</p> <p>Intentional interruption is prohibited.</p> <p>Lethal voltages inside the instrument</p> <p>When the instrument is connected to line power, terminals may be live and opening covers or removing parts is likely to expose live parts.</p>
---	---

<p>WARNING</p> 	<p>Damage to electronics [W9]</p> <p>Before powering ON the instrument, make sure that the correct supply voltage is used.</p> <p>Use of incorrect supply voltage may damage the electronics.</p> <p>To check the recommended supply voltage, refer to the specifications indicated in the type plate of the instrument.</p>
---	---

<p>WARNING</p> 	<p>Risk of electric shock [W10]</p> <p>Do not open any panels on the QIAcube Connect MDx.</p> <p>Risk of personal injury and material damage</p> <p>Only perform maintenance that is specifically described in this user manual.</p>
---	--

To ensure satisfactory and safe operation of the QIAcube Connect MDx, follow these guidelines:

- The line power cord must be connected to a line power outlet that has a protective conductor (earth/ground).
- Do not adjust or replace internal parts of the instrument.
- Do not operate the instrument with any covers or parts removed.
- If liquid has spilled inside the instrument, power OFF the instrument, disconnect it from the power outlet, and contact QIAGEN Technical Services.

If the instrument becomes electrically unsafe, prevent other personnel from operating it, and contact QIAGEN Technical Services.

The instrument may be electrically unsafe when:

- It or the line power cord appears to be damaged.
- It has been stored under unfavorable conditions for a prolonged period.
- It has been subjected to severe transport stresses.
- Liquids come in contact directly with electrical components of the QIAcube Connect MDx.

2.3 Environment

Parameters such as temperature range and humidity range are described in section 9, Appendix A – Technical data.

Operating conditions

WARNING 	Explosive atmosphere [W11] The QIAcube Connect MDx is not designed for use in an explosive atmosphere.
---	--

CAUTION 	Damage to the instrument [C6] Direct sunlight may bleach parts of the instrument and cause damage to plastic parts. The QIAcube Connect MDx must be located out of direct sunlight.
---	--

2.4 Biological safety

Specimens and reagents containing materials from humans should be treated as potentially infectious. Use safe laboratory procedures as outlined in publications such as Biosafety in Microbiological and Biomedical Laboratories, HHS (www.cdc.gov/labs/pdf/CDC-BiosafetyMicrobiologicalBiomedicalLaboratories-2009-P.PDF).

Samples may contain infectious agents. You should be aware of the health hazard presented by such agents and should use, store, and dispose of such samples according to the required safety regulations.

<p>WARNING</p> 	<p>Samples containing infectious agents [W12]</p> <p>Some samples used with this instrument may contain infectious agents. Handle such samples with the greatest of care and in accordance with the required safety regulations.</p> <p>Always wear safety glasses, 2 pairs of gloves, and a lab coat.</p> <p>The responsible body (e.g., laboratory manager) must take the necessary precautions to ensure that the surrounding workplace is safe, and that the instrument operators are suitably trained and not exposed to hazardous levels of infectious agents as defined in the applicable Material Safety Data Sheets (MSDSs) or OSHA*, ACGIH† or COSHH‡ documents.</p> <p>Venting for fumes and disposal of wastes must be in accordance with all national, state, and local health and safety regulations and laws.</p>
---	---

2.5 Chemicals

<p>WARNING</p> 	<p>Hazardous chemicals [W13]</p> <p>Some chemicals used with this instrument may be hazardous or may become hazardous after completion of the protocol run.</p> <p>Always wear safety glasses, gloves, and a lab coat.</p> <p>The responsible body (e.g., laboratory manager) must take the necessary precautions to ensure that the surrounding workplace is safe and that the instrument operators are not exposed to hazardous levels of toxic substances (chemical or biological) as defined in the applicable Material Safety Data Sheets (MSDSs) or OSHA*, ACGIH† or COSHH‡ documents.</p> <p>Venting for fumes and disposal of wastes must be in accordance with all national, state, and local health and safety regulations and laws.</p>
--	---

Toxic fumes

If working with volatile solvents or toxic substances, you must provide an efficient laboratory ventilation system to remove vapors that may be produced.

<p>WARNING</p> 	<p>Toxic fumes [W14]</p> <p>Do not use bleach to clean or disinfect the QIAcube Connect MDx. Bleach in contact with salts from the buffers can produce toxic fumes.</p>
---	--

* OSHA : Occupational Safety and Health Administration (United States of America).

† ACGIH : American Conference of Government Industrial Hygienists (United States of America).

‡ COSHH : Control of Substances Hazardous to Health (United Kingdom).

WARNING 	Toxic fumes [W15] Do not use bleach to disinfect used labware. Bleach in contact with salts from the buffers used can produce toxic fumes.
---	--

2.6 Waste disposal

Used labware, such as sample tubes, QIAGEN spin columns, filter-tips, buffer bottle and enzyme tubes, or rotor adapters, may contain hazardous chemicals or infectious agents from the purification process. These hazardous wastes must be collected and disposed of properly according to local safety regulations.

For more information about how to dispose of the QIAcube Connect MDx, see section 9.6, Waste Electrical and Electronic Equipment (WEEE).

WARNING 	Hazardous chemicals and infectious agents [W16] The waste may contain toxic material and must be disposed of properly. Refer to your local safety regulations for proper disposal procedures.
---	---

2.7 Mechanical hazards

The hood of the QIAcube Connect MDx must remain closed during operation of the instrument. Only open the hood when instructed to do so by the instruction for use.

While loading the worktable, always stand clear of the instrument. Do not lean on the worktable when the robotic arm of the instrument is moving to reach loading position with its lid open. Wait until the robotic arm completed its movements before you start to load or unload.

WARNING 	Moving parts [W17] Avoid contact with moving parts during operation of the QIAcube Connect MDx. Under no circumstances should you place your hands under the robotic arm when it is lowering. Do not attempt to move any tip racks or tubes whilst the instrument is operating.
---	---

<p>WARNING</p> 	<p>Moving parts [W18]</p> <p>To avoid contact with moving parts during operation of the QIAcube Connect MDx, the instrument must be operated with the hood closed.</p> <p>If the hood sensor or lock is not functioning correctly, contact QIAGEN Technical Services.</p>
---	--

2.7.1 Centrifuge

Make sure that the rotor and buckets are installed correctly. All buckets must be mounted before starting a protocol run, regardless of the number of samples to be processed. If the rotor or buckets show signs of mechanical damage or corrosion, do not use the QIAcube Connect MDx; contact QIAGEN Technical Services.

<p>CAUTION</p> 	<p>Damage to the instrument [C7]</p> <p>The QIAcube Connect MDx must not be used if the centrifuge lid is broken, or if the lid lock is damaged.</p> <p>Make sure that no loose material is inside the centrifuge during operation.</p> <p>Make sure that the rotor is installed correctly and that all buckets are properly mounted, regardless of the number of samples to be processed. Load the rotor only as instructed by the software.</p> <p>Only use rotors, buckets, and consumables designed for use with the QIAcube Connect MDx. Damage caused by use of other consumables will void your warranty.</p> <p>We recommend replacing the centrifuge rotor and buckets after 20,000 cycles, which is equivalent to 9 years of usage with two runs per day for 220 days each year. For more information contact QIAGEN Technical Services.</p>
---	---

In case of breakdown caused by power failure, the centrifuge lid can be opened manually to remove the samples (see section 7.3.2).

<p>WARNING</p> 	<p>Moving parts [W19]</p> <p>In case of breakdown caused by power failure, remove the power cord and wait 10 minutes before attempting to manually open the centrifuge lid.</p>
---	--

CAUTION 	<p>Damage to the instrument [C8]</p> <p>After a power failure, do not move the z-module (robotic arm) manually in front of the instrument. Damage may occur if the QIAcube Connect MDx hood is closed and collides with the z-module.</p>
---	--

WARNING 	<p>Risk of personal injury and material damage [W20]</p> <p>Raise the centrifuge lid carefully. The lid is heavy and may cause injury if it falls.</p>
---	---

CAUTION 	<p>Risk of overheating [C9]</p> <p>To ensure proper ventilation, maintain a minimum clearance of 10 cm at the sides and rear of the QIAcube Connect MDx.</p> <p>Slits and openings that ensure the ventilation of the QIAcube Connect MDx must not be covered.</p>
---	---







2.8 Heat hazard

The QIAcube Connect MDx worktable contains a heated shaker.

WARNING 	<p>Hot surface [W21]</p> <p>The shaker can reach temperatures of up to 70°C (158°F). Avoid touching it when it is hot. Carefully remove the samples after a run.</p>
---	---

2.9 Maintenance safety

WARNING/ CAUTION 	<p>Risk of personal injury and material damage [W22]</p> <p>Only perform maintenance that is specifically described in this user manual.</p>
--	---

<p>WARNING</p> 	<p>Risk of explosion [W23]</p> <p>When cleaning the QIAcube Connect MDx with alcohol-based disinfectant, leave the QIAcube Connect MDx hood open to allow flammable vapors to disperse.</p> <p>Only clean the QIAcube Connect MDx when worktable components have cooled down.</p>
<p>WARNING</p> 	<p>Risk of fire [W24]</p> <p>Do not allow cleaning fluid or decontamination agents to come into contact with the electrical parts of the QIAcube Connect MDx.</p>
<p>WARNING</p> 	<p>Risk of personal injury and material damage [W25]</p> <p>To prevent the rotor nuts from loosening during operation of the centrifuge, securely tightened the nuts using the rotor key supplied with QIAcube Connect MDx.</p>
<p>WARNING</p> 	<p>UV irradiation hazard [W26]</p> <p>A mechanical lock ensures that the hood must be closed for operation of the UV LED.</p> <p>If the hood sensor or lock is not functioning correctly, contact QIAGEN Technical Services.</p>
<p>WARNING</p> 	<p>Risk of personal injury and material damage [W27]</p> <p>Make sure that lids from spin columns and 1.5 ml microcentrifuge tubes are in the correct position and pushed all the way down to the bottom of the slots on the sides of the rotor adapter. Incorrectly positioned lids can break off during centrifugation.</p>
<p>WARNING</p> 	<p>Risk of personal injury and material damage [W28]</p> <p>Be sure the lid is completely removed from the spin column. Spin columns with partially removed lids may not be removed properly from the rotor, causing the protocol run to crash.</p>
<p>CAUTION</p> 	<p>Damage to the instrument [C10]</p> <p>Do not use bleach, solvents, or reagents containing acids, alkalis or abrasives to clean QIAcube Connect MDx.</p>

CAUTION 	Damage to the instrument [C11] Do not use spray bottles containing alcohol or disinfectant to clean surfaces of the QIAcube Connect MDx. Spray bottles should be used only to clean items that have been removed from the worktables.
---	---

2.10 Radiation safety

WARNING 	Risk of personal injury [W29] Do not expose your skin to UV-C light from the UV LED lamp.
---	---

WARNING 	Risk of personal injury [W30] Hazard Level 2 laser light: Do not stare into the light beam when using handheld bar code scanner.
---	--

2.11 Symbols on the QIAcube Connect MDx

Symbol	Location	Description
	Next to the Shaker	Heat hazard – the temperature of the shaker can reach up to 70°C (158°F).
	Near the centrifuge; near the robotic arm	Mechanical hazard – avoid contact with moving parts.
	On the instrument, near bottle rack	Fire hazard – usage of ethanol in bottle rack.
	In front of worktable	Biological hazard – some samples used with this instrument may contain infectious agents and must be handled with gloves.
	Inside the waste drawer	Biohazard – the waste drawer may be contaminated with biohazardous material and must be handled with gloves.
	Type plate on the back of the instrument	CE mark for European Conformity
	Type plate at the back of the instrument	CSA listing mark for Canada and the USA
	Type plate on the back of the instrument	FCC mark of the United States Federal Communications Commission
	Type plate on the back of the instrument	RCM mark for Australia and New Zealand
	Type plate on the back of the instrument	RoHS mark for China (the restriction of the use of certain hazardous substances in electrical and electronic equipment)
	Type plate on the back of the instrument	Waste Electrical and Electronic Equipment (WEEE) mark for Europe
	Type plate on the back of the instrument	Legal manufacturer
	At the back of the instrument	Consult instructions for use
	Type plate at the back of the instrument	See warnings and precautions
	Type plate at the back of the instrument	In vitro diagnostic medical device

3 General Description

The QIAcube Connect MDx performs fully automated isolation and purification of nucleic acids in molecular diagnostic and molecular biology applications.

It can process up to 12 samples per single run. The QIAcube Connect MDx is designed to automate selected QIAGEN DSP and non-DSP kits and the PAXgene Blood RNA Kit. The QIAcube Connect MDx controls integrated components, including a centrifuge, heated shaker, pipetting system, UV LED and robotic gripper.

The QIAcube Connect MDx gives the option to start a protocol either in the IVD mode of the software (for validated IVD applications only) or in the Research mode of the software (for Molecular Biology Applications (MBA) only). The usage of IVD protocols is only possible and strictly restricted to the IVD mode of the software. This User Manual focuses on operating the QIAcube Connect MDx in the IVD-software mode. For detailed instructions on how to operate the QIAcube Connect MDx using the Research mode of the software (with MBA-protocols or any customized protocols), please refer to the **User Manual of the QIAcube Connect** (available on the QIAcube Connect product webpage under the **Product Resources** tab).

QIAcube Connect MDx is preinstalled with various protocols for processing QIAGEN spin columns for purification of RNA, genomic DNA and viral nucleic acids. In the Research mode of the software, further protocols are available, for e.g. plasmid DNA and protein purification as well as DNA and RNA cleanup. The user first selects the software mode for the type of application to be performed using the touchscreen, then chooses an application or scans a kit barcode and loads labware, samples, and reagents onto the QIAcube Connect MDx worktable. The user then closes the instrument hood and starts the protocol, which provides all necessary commands for sample lysis and purification using QIAGEN spin columns. A fully automated load check helps to ensure correct loading of the worktable.

Offering an augmented user interface, users stay connected to their instrument through the built-in screen and also remotely with a computer or a mobile device (e.g., a tablet) and the QIASphere App using the associated QIASphere Connectivity Package (see section 10, Appendix B - QIAcube Connect MDx Accessories), enabling quick response times and ability to monitor runs while being away from the instrument.

Note: Setup of a run on a mobile device (e.g., a tablet) and transfer of the information to the QIAcube Connect MDx instrument is only possible with the Research mode of the software. The IVD

mode of the software does not support this feature. Instead, the user needs to be in front of the instrument and use the touchscreen of the instrument to set up a run.

3.1 QIAcube Connect MDx principle

Sample preparation using the QIAcube Connect MDx follows the same steps as the manual procedure (i.e., lyse, bind, wash and elute). Depending on chosen application, the procedure may be alternated, or steps may not be required. Moving forward to laboratory automation, no change in purification chemistry is required as you simply continue to use trusted QIAGEN spin-column kits.

1. Samples are lysed in the orbital shaker, which can be heated if required by the protocol.
2. Each lysate is transferred to a spin column in a rotor adapter. If the lysate needs to be homogenized or cleared, it is first transferred to the middle position of the rotor adapter.
3. Nucleic acids or proteins bind to the silica membrane or purification resin of the QIAGEN spin column and are washed to remove contaminants.
4. The spin column is transferred to a microcentrifuge tube for elution of purified nucleic acids or protein.

For an example workflow using a QIAGEN spin-column kit, see the QIAamp DNA DSP Procedure flowchart on the next page.

QIAamp DNA DSP Procedure

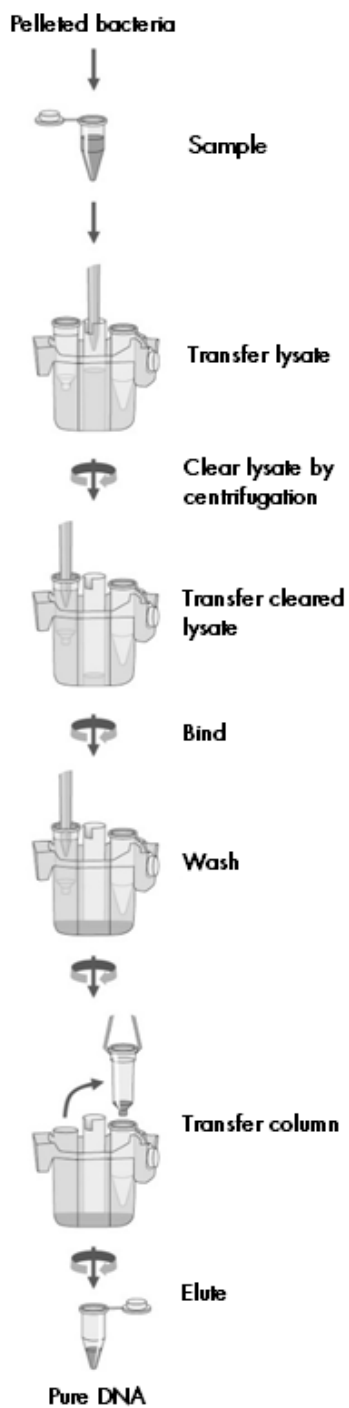

QIAamp DNA DSP procedure flowchart

3.2 External features of the QIAcube Connect MDx



Front view of the QIAcube Connect MDx

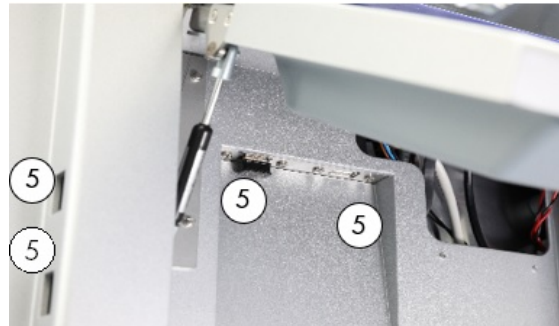

Pulled-out touchscreen



Rear view of QIAcube Connect MDx



Rear view of QIAcube Connect MDx

- | | | | |
|---|--------------|---|--|
| 1 | Touchscreen | 5 | 2 USB ports on the left side of the touchscreen; 2 USB ports behind the touchscreen (Wi-Fi module plugged into 1 USB port) |
| 2 | Hood | 6 | RJ-45 Ethernet port |
| 3 | Waste drawer | 7 | Power cord socket |
| 4 | Power switch | 8 | Cooling air outlet |
| | | 9 | External barcode scanner (not depicted) |

Touchscreen

The QIAcube Connect MDx is controlled using a swivel-mounted touchscreen. The touchscreen allows the user to operate the instrument and to guide the user through worktable setup. During sample processing, the touchscreen shows the protocol status and remaining time.



Pulled-out touchscreen

Hood

The QIAcube Connect MDx hood protects users from the moving robotic arm and from potentially infectious material placed on the worktable. The hood can be manually opened to gain access to the worktable. During operation of the QIAcube Connect MDx, the hood must remain closed and should only be opened when instructed to do so by the software. Therefore, a hood lock has been implemented to avoid inappropriate opening.

<p>WARNING</p> 	<p>Moving parts [W18]</p> <p>To avoid contact with moving parts during operation of the QIAcube Connect MDx, the instrument must be operated with the hood closed.</p> <p>If the hood sensor or lock is not functioning correctly, contact QIAGEN Technical Services.</p>
---	--

Power switch

The power switch is located at the front right of the QIAcube Connect MDx and is used to power ON and OFF the instrument.

RJ-45 Ethernet port

The RJ-45 Ethernet port located at the back of the instrument beside the power cord socket, is only used to connect the QIAcube Connect MDx to local area network via cable.

USB ports

The QIAcube Connect MDx has four USB ports. Two are located on the left of the touchscreen and two are located behind the touchscreen.

The USB ports located on the left of the touchscreen allow connection of the QIAcube Connect MDx to a USB flash drive. Data files, such as support package, protocols or report files, can be transferred via the USB port from the QIAcube Connect MDx to the USB flash drive. The USB ports can also be used to plug in the supplied external barcode scanner.

USB ports located below the touchscreen, allow insertion of a Wi-Fi adapter to enable Wi-Fi connection to a local network.



Important: Use only the USB flash drive provided by QIAGEN. Do not connect other USB flash drive devices to USB ports.

Important: Do not remove the USB flash drive while downloading or transferring data or software to or from the instrument.

Important: Always turn off the QIAcube Connect MDx in order to plug or unplug the Wi-Fi USB device. Plug-and-play of the Wi-Fi USB device while the instrument is turned on is not supported.

Waste drawer

Used disposable filter-tips are discarded through two slots in the worktable and collected in the waste drawer. Used columns (e.g., QIAshredder columns) are also discarded into this drawer.

<p>CAUTION</p> 	<p>Damage to the instrument [C3]</p> <p>Empty the tip disposal container prior to use to prevent a tip jam in the waste drawer. Failure to empty the waste container may block the robotic arm that could cause run failure or instrument damage.</p>
<p>WARNING</p> 	<p>Hazardous chemicals and infectious agents [W16]</p> <p>The waste may contain toxic material and must be disposed of properly. Refer to your local safety regulations for proper disposal procedures.</p>

<p>WARNING</p> 	<p>Hazardous chemicals [W13]</p> <p>Some chemicals used with this instrument may be hazardous or may become hazardous after completion of the protocol run.</p> <p>Always wear safety glasses, gloves, and a lab coat.</p> <p>The responsible body (e.g., laboratory manager) must take the necessary precautions to ensure that the surrounding workplace is safe and that the instrument operators are not exposed to hazardous levels of toxic substances (chemical or biological) as defined in the applicable Material Safety Data Sheets (MSDSs) or OSHA*, ACGIH† or COSHH‡ documents.</p> <p>Venting for fumes and disposal of wastes must be in accordance with all national, state, and local health and safety regulations and laws.</p>
---	---

<p>WARNING</p> 	<p>Samples containing infectious agents [W12]</p> <p>Some samples used with this instrument may contain infectious agents. Handle such samples with the greatest of care and in accordance with the required safety regulations.</p> <p>Always wear safety glasses, 2 pairs of gloves, and a lab coat.</p> <p>The responsible body (e.g., laboratory manager) must take the necessary precautions to ensure that the surrounding workplace is safe, and that the instrument operators are suitably trained and not exposed to hazardous levels of infectious agents as defined in the applicable Material Safety Data Sheets (MSDSs) or OSHA§, ACGIH** or COSHH†† documents.</p> <p>Venting for fumes and disposal of wastes must be in accordance with all national, state, and local health and safety regulations and laws.</p>
---	---

Power cord socket

The power cord socket is located at the rear right of the QIAcube Connect MDx and allows connection of the QIAcube Connect MDx to a power outlet via the supplied power cord.

* OSHA : Occupational Safety and Health Administration (United States of America).

† ACGIH : American Conference of Government Industrial Hygienists (United States of America).

‡ COSHH : Control of Substances Hazardous to Health (United Kingdom).

§ OSHA : Occupational Safety and Health Administration (United States of America).

** ACGIH : American Conference of Government Industrial Hygienists (United States of America).

†† COSHH : Control of Substances Hazardous to Health (United Kingdom).

<p>WARNING</p> 	<p>Electrical hazard [W8]</p> <p>Any interruption of the protective conductor (earth/ground lead) inside or outside the instrument or disconnection of the protective conductor terminal is likely to make the instrument dangerous.</p> <p>Intentional interruption is prohibited.</p> <p>Lethal voltages inside the instrument</p> <p>When the instrument is connected to line power, terminals may be live and opening covers or removing parts is likely to expose live parts.</p>
---	---

<p>WARNING</p> 	<p>Damage to electronics [W9]</p> <p>Before powering ON the instrument, make sure that the correct supply voltage is used.</p> <p>Use of incorrect supply voltage may damage the electronics.</p> <p>To check the recommended supply voltage, refer to the specifications indicated in the type plate of the instrument.</p>
---	--

<p>WARNING</p> 	<p>Risk of electric shock [W10]</p> <p>Do not open any panels on the QIAcube Connect MDx.</p> <p>Risk of personal injury and material damage</p> <p>Only perform maintenance that is specifically described in this user manual.</p>
---	---

Cooling air outlet

Cooling air outlets are located at the rear left side of the QIAcube Connect MDx and allow cooling of the internal components of the QIAcube Connect MDx.

<p>CAUTION</p> 	<p>Risk of overheating [C9]</p> <p>To ensure proper ventilation, maintain a minimum clearance of 10 cm at the sides and rear of the QIAcube Connect MDx.</p> <p>Slits and openings that ensure the ventilation of the QIAcube Connect MDx must not be covered.</p>
---	--

External barcode scanner

The QIAcube Connect MDx is equipped with a 2D handheld barcode scanner to allow kit bar code and sample bar code scanning.

WARNING 	Risk of personal injury Hazard Level 2 laser light: Do not stare into the light beam when using handheld bar code scanner.	[W30]
---	--	--------------

3.3 Internal features of the QIAcube Connect MDx

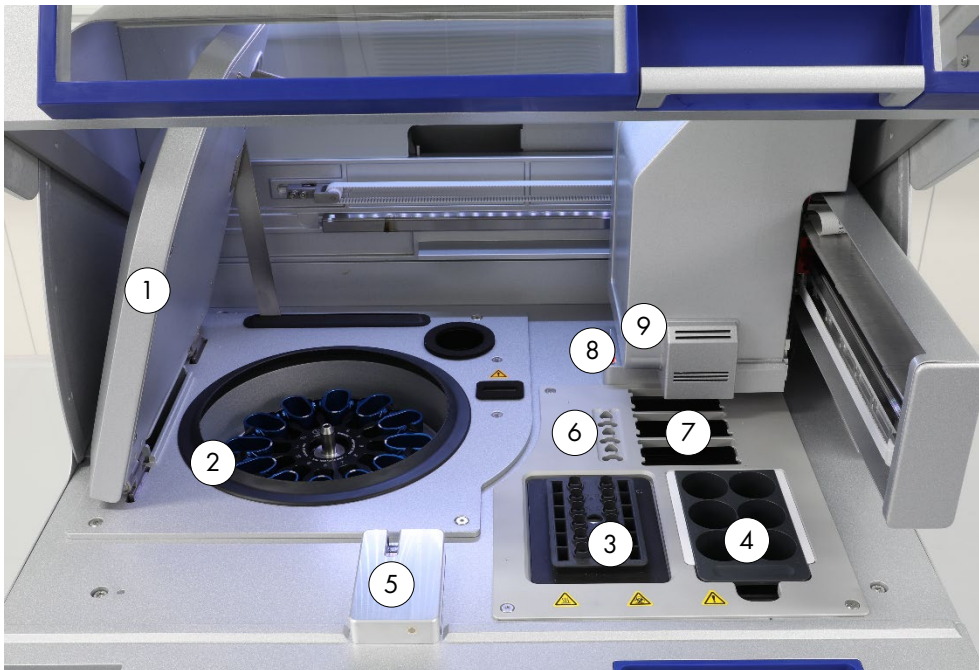

Internal view of the QIAcube Connect MDx.

- | | | | |
|---|--------------------------|---|---|
| 1 | Centrifuge lid | 6 | Microcentrifuge tube slots |
| 2 | Centrifuge | 7 | 3 Slots for tip racks |
| 3 | Shaker | 8 | Disposal slots for tips and columns |
| 4 | Reagent bottle rack | 9 | Robotic arm (includes gripper, pipetting system, optical sensor, ultrasonic sensor, and UV LED) |
| 5 | Tip sensor and hood lock | | |

Centrifuge

The centrifuge is equipped with 12 swing-out buckets, each of which can hold a disposable rotor adapter. Up to 12 samples can be processed per run. For ease of use and high process safety, a grey line marks the side of the bucket that must face toward the center of the rotor. All centrifuge buckets must be mounted before starting a run, regardless of the number of samples to be processed. Be sure to follow the loading instructions provided by the software to ensure correct loading of the centrifuge.

The centrifuge can also be operated individually via the touchscreen (refer to section 6.6.3, Operating the centrifuge after cleaning).

Note: Be sure to follow the centrifuge loading instructions provided by the software.

WARNING 	Risk of personal injury and material damage [W5] To prevent plastic crash, load the tubes properly. After a plastic crash, sharp plastic particles could be inside the centrifuge. Be careful when handling items inside the centrifuge.
---	--

WARNING 	Risk of personal injury and material damage [W20] Raise the centrifuge lid carefully. The lid is heavy and may cause injury if it falls.
---	--

Shaker

The heated orbital shaker enables fully automated lysis of up to 12 samples. Two kinds of shaker adapters are available for 2 ml microcentrifuge tubes and 2 ml screw-cap tubes. Sample tubes are placed into a rack that fits onto the shaker adapter. The lid of each microcentrifuge tube or shaker rack plug of each screw-cap tube is held in a slot at the edge of the shaker rack. This ensures that microcentrifuge tubes cannot be displaced during sample processing and allows shaker loading to be checked. The shaker can also be operated individually via the touchscreen (see section 5.1, QIAcube Connect MDx software).

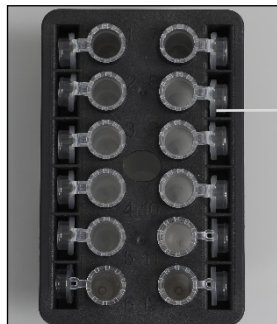

Sample tube lids are held in slots at the edge of the shaker rack

Shaker rack with 2ml microcentrifuge tubes

Note: For shaker loading follow instructions provided by the software.

WARNING 	Risk of personal injury and material damage [W5] To prevent plastic crash, load the tubes properly. After a plastic crash, sharp plastic particles could be inside the centrifuge. Be careful when handling items inside the centrifuge.
---	--

WARNING 	Hot surface [W21] The shaker can reach temperatures of up to 70°C (158°F). Avoid touching it when it is hot. Carefully remove the samples after a run.
---	--





Reagent bottle rack

The reagent bottle rack holds up to six 30 ml QIAcube Connect MDx specific reagent bottles and, for ease of use and high process safety, fits onto the QIAcube Connect MDx worktable only in the correct orientation. Liquid is aspirated from the bottles by the pipetting system. A labeling strip should be attached to the reagent bottle rack. For increased convenience and ease of use, the labeling strip fits only in the correct orientation on the reagent bottle rack. The use of the labeling strip ensures that the rack is correctly positioned on the worktable for liquid-level detection.

Note: Reagent bottles designed for use with the QIAcube Connect MDx and supplied by QIAGEN must be used. Otherwise, errors may occur during liquid detection.



Reagent bottle rack with white labeling strips at the sides

<p>WARNING</p> 	<p>Risk of fire or explosion [W6]</p> <p>When using ethanol or ethanol-based liquids on the QIAcube Connect MDx, handle such liquids carefully and in accordance with the required safety regulations. If liquid has been spilled, wipe it off and leave the QIAcube Connect MDx hood open to allow flammable vapors to disperse.</p>
<p>WARNING</p> 	<p>Risk of explosion [W7]</p> <p>The QIAcube Connect MDx is intended for use with reagents and substances supplied with QIAGEN kits or other than outlined in respective Information for use. Use of other reagents and substances may lead to fire or explosion.</p>
<p>WARNING</p> 	<p>Risk of personal injury and material damage [W5]</p> <p>To prevent plastic crash, load the tubes properly. After a plastic crash, sharp plastic particles could be inside the centrifuge. Be careful when handling items inside the centrifuge.</p>
<p>WARNING</p> 	<p>Hot surface [W21]</p> <p>The shaker can reach temperatures of up to 70°C (158°F). Avoid touching it when it is hot. Carefully remove the samples after a run.</p>

Tip sensor

During sample preparation, the tip sensor checks that the tip adapter has picked up a tip and checks whether it is a 200 µl or a 1000 µl type filter-tip.

Microcentrifuge tube slots

In addition to the 12 tubes that the shaker can accommodate, up to 3 additional microcentrifuge tubes can be used in the microcentrifuge accessory position. These slots are used by applications in which, for example, proteinase K or another enzyme is required for the purification protocol.

Tip rack slots

Three tip racks can be placed on the QIAcube Connect MDx worktable. Tips can be purchased in prefilled tip racks holding 200 µl filter-tips or 1000 µl filter-tips, regular or wide-bore.

Note: Only filter-tips designed for use with the QIAcube Connect MDx and supplied by QIAGEN must be used.

Disposal slots for tips and columns

Disposable filter-tips are alternately discarded through each of the round-shaped tip disposal slots into the waste drawer. This prevents discarded tips from piling up in the waste drawer.

Used columns (e.g., QIAshredder columns) are discarded through the square-shaped disposal slot into the waste drawer.

Robotic arm

The robotic arm provides accurate and precise positioning of the robotic gripper and pipetting system on the QIAcube Connect MDx worktable and includes an optical and ultrasonic sensor, as well as a UV LED.

<p>WARNING</p> 	<p>Moving parts [W18]</p> <p>To avoid contact with moving parts during operation of the QIAcube Connect MDx, the instrument must be operated with the hood closed.</p> <p>If the hood sensor or lock is not functioning correctly, contact QIAGEN Technical Services.</p>
---	--

WARNING 	Moving parts Avoid contact with moving parts during operation of the QIAcube Connect MDx. Under no circumstances should you place your hands under the robotic arm when it is lowering. Do not attempt to move any tip racks or tubes whilst the instrument is operating.	[W17]
---	---	--------------

Robotic gripper

The robotic gripper transfers spin columns. During transfer of a spin column, a stabilizing rod holds the rotor adapter in place, ensuring it remains properly seated in the centrifuge bucket. The robotic gripper is behind the panel covering the robotic arm.



Robotic gripper

Stabilizing rod

Robotic gripper automates spin-column processing

Pipetting system

The QIAcube Connect MDx is equipped with a single-channel pipetting system that moves in the X, Y and Z directions. The dilutor, fitted with a tip adapter, is connected to a precision syringe pump, which enables accurate transfer of liquids. The tip adapter allows aspiration and dispensing of liquid through an attached disposable tip. Disposable filter-tips (200 µl, 1000 µl and 1000 µl wide-bore) are used for sample processing to minimize the risk of cross-contamination.

Optical sensor

During the load check, the optical sensor checks that the number of rotor adapters corresponds to the number of samples in the shaker and that both shaker and rotor are correctly loaded. The optical sensor also checks the type of tips loaded on the worktable and whether there are enough tips for the protocol run.

Ultrasonic sensor

During the load check, the ultrasonic sensor checks that the buffer bottles in the reagent bottle rack contain enough buffer for the protocol run.

Note: The ultrasonic sensor has a black beam collimator. If, for any reason, this beam collimator falls off or is missing, the instrument will display an error message to inform the user that the beam collimator is missing and that runs cannot be started. To replace the beam collimator (see image below), push it manually into its original position. If you are still having difficulties and the error message remains, contact your local technical service department for further support.

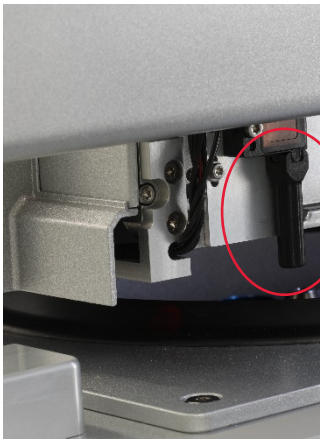

Black beam collimator (see red circle) of the ultrasonic sensor

Speakers

The system is equipped with speakers with different audio signals to notify different instrument states such as:

- Run completed
- Error
- Aborted run

Interior LED

The QIAcube Connect MDx is equipped with an interior LED which illuminates the worktable for ease of use. The LED can also indicate the instrument status (e.g. error) by blinking.

UV LED

The QIAcube Connect MDx is equipped with a UV LED light for decontamination. During the maintenance decontamination procedure, the UV LED is moved over the worktable. The hood and the waste drawer must be closed before starting the procedure and must not be opened during the procedure.

WARNING 	Risk of personal injury Do not expose your skin to UV-C light from the UV LED lamp.	[W29]
---	---	--------------

3.4 Disposables

Rotor adapter

A disposable rotor adapter holds a QIAGEN spin column and a microcentrifuge tube in a centrifuge bucket during sample processing. If required by the protocol, an additional column (e.g., QIAshredder column) can be placed in the middle position of the rotor adapter. For ease of use and high process safety, the rotor adapters are designed so that they fit into a centrifuge bucket only in the correct orientation. Spin-column and microcentrifuge tube lids are held securely in slots at the edge of the rotor adapter.

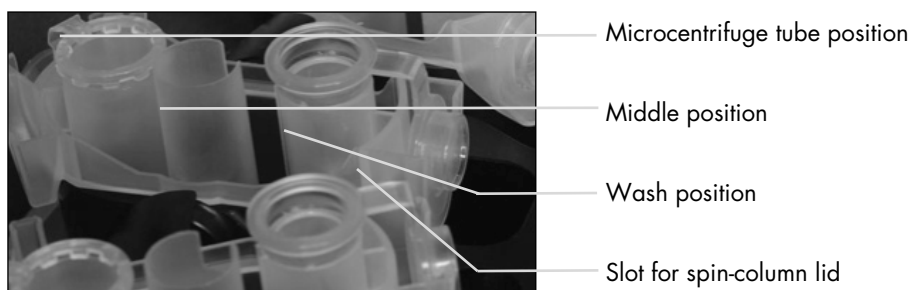

Assembly of a rotor adapter

The wash position of the rotor adapter is open at the bottom, enabling wash buffers to flow through and collect at the bottom of the rotor adapter during centrifugation. The other two positions in the rotor adapter are closed. Be sure to follow the loading instructions provided by the software.

WARNING 	Risk of personal injury and material damage [W4] Do not use damaged rotor adapters. The rotor adapters can only be used once. High g forces exerted in the centrifuge can cause damage to used rotor adapters.
---	--

WARNING 	Risk of personal injury and material damage [W5] To prevent plastic crash, load the tubes properly. After a plastic crash, sharp plastic particles could be inside the centrifuge. Be careful when handling items inside the centrifuge.
---	--

4 Installation Procedures

This section provides instructions on installation environment requirements as well as unpacking, installing, configuring and packing the QIAcube Connect MDx.

4.1 Installation environment

4.1.1 Site requirements

The QIAcube Connect MDx must be located out of direct sunlight, away from heat sources and away from sources of vibration and electrical interference. Refer to Appendix A – Technical data for the operating conditions (temperature and humidity). The site of installation should be free of excessive drafts, excessive moisture and excessive dust and should not be subject to large temperature fluctuations.

Use a level workbench that is large enough and strong enough to accommodate the QIAcube Connect MDx. Refer to Appendix A – Technical data for the weight and dimensions of the QIAcube Connect MDx.

Ensure that the workbench is dry, clean, vibration-proof, and has additional space for accessories.

Do not use this device in close proximity to sources of strong electromagnetic radiation (e.g. unshielded intentional RF sources), as these can interfere with proper operation.

The QIAcube Connect MDx must be placed within approximately 1.5 m of a properly grounded (earthed) AC power outlet. The power line to the instrument should be voltage regulated and surge protected. Ensure that the QIAcube Connect MDx is positioned so that it is easy to access the power connector at the back of the instrument and the power switch on the front at all times, and that it is easy to power the instrument OFF and disconnect it.

Note: It is recommended to plug the instrument directly into its own power outlet and not to share the power outlet with another lab equipment. Do not place the QIAcube Connect MDx on a vibrating surface or near vibrating objects.

<p>WARNING</p> 	<p>Explosive atmosphere [W11]</p> <p>The QIAcube Connect MDx is not designed for use in an explosive atmosphere.</p>
---	---

CAUTION 	<p>Risk of overheating [C9]</p> <p>To ensure proper ventilation, maintain a minimum clearance of 10 cm at the sides and rear of the QIAcube Connect MDx.</p> <p>Slits and openings that ensure the ventilation of the QIAcube Connect MDx must not be covered.</p>
---	---

WARNING 	<p>Risk of personal injury and material damage [W2]</p> <p>The QIAcube Connect MDx is too heavy to be lifted by one person. To avoid personal injury or damage to the instrument, do not lift the instrument alone.</p>
---	--

CAUTION 	<p>Damage to the instrument [C6]</p> <p>Direct sunlight may bleach parts of the instrument and cause damage to plastic parts.</p> <p>The QIAcube Connect MDx must be located out of direct sunlight.</p>
---	---

4.1.2 Power requirements

The QIAcube Connect MDx operates at: 100–240 V AC, 50/60 Hz, 650 VA. It can be connected to an uninterruptible power supply (UPS).

Ensure that the voltage rating of the QIAcube Connect MDx is compatible with the AC voltage available at the installation site. Mains supply voltage fluctuations are not to exceed 10% of nominal supply voltages.

WARNING 	<p>Damage to electronics [W9]</p> <p>Before powering ON the instrument, make sure that the correct supply voltage is used.</p> <p>Use of incorrect supply voltage may damage the electronics.</p> <p>To check the recommended supply voltage, refer to the specifications indicated in the type plate of the instrument.</p>
---	---

<p>WARNING</p> 	<p>Electrical hazard [W8]</p> <p>Any interruption of the protective conductor (earth/ground lead) inside or outside the instrument or disconnection of the protective conductor terminal is likely to make the instrument dangerous.</p> <p>Intentional interruption is prohibited.</p> <p>Lethal voltages inside the instrument</p> <p>When the instrument is connected to line power, terminals may be live and opening covers or removing parts is likely to expose live parts.</p>
---	--

4.1.3 Grounding requirements

To protect operating personnel, the National Electrical Manufacturers' Association (NEMA) recommends that the QIAcube Connect MDx be correctly grounded (earthed). The instrument is equipped with a 3-conductor AC power cord that, when connected to an appropriate AC power outlet, grounds (earths) the instrument. To preserve this protection feature, do not operate the instrument from an AC power outlet that has no ground (earth) connection.

<p>WARNING</p> 	<p>Electrical hazard [W8]</p> <p>Any interruption of the protective conductor (earth/ground lead) inside or outside the instrument or disconnection of the protective conductor terminal is likely to make the instrument dangerous.</p> <p>Intentional interruption is prohibited.</p> <p>Lethal voltages inside the instrument</p> <p>When the instrument is connected to line power, terminals may be live and opening covers or removing parts is likely to expose live parts.</p>
---	--

4.2 Unpacking the QIAcube Connect MDx

<p>WARNING</p> 	<p>Risk of personal injury and material damage [W2]</p> <p>The QIAcube Connect MDx is too heavy to be lifted by one person. To avoid personal injury or damage to the instrument, do not lift the instrument alone.</p>
---	--

1. Before unpacking the QIAcube Connect MDx, move the package to the site of installation and check that the arrows on the package point upward. In addition, check whether the package is damaged. In case of damage, contact QIAGEN Technical Service.
2. Open the top of the transportation box to remove the *QIAcube Connect MDx Quick-Start Guide*, barcode scanner, and power cord before lifting the box.

3. Remove the black foam protector lid and lift the box.
4. When lifting the QIAcube Connect MDx, slide your fingers under both sides of the workstation and keep your back straight.
Important: Do not hold the touchscreen display while unpacking or lifting the QIAcube Connect MDx, this might damage the instrument.
5. Check if the packing list document is included after unpacking the QIAcube Connect MDx.
6. Read the packing list to check that you have received all items. If anything is missing, contact QIAGEN Technical Services.
7. Check that the QIAcube Connect MDx is not damaged and that there are no loose parts. If anything is damaged, contact QIAGEN Technical Services. Make sure that the QIAcube Connect MDx has equilibrated to ambient temperature before operating it.
8. Retain the package in case you need to transport the QIAcube Connect MDx in the future. Refer to section 4.5, Packing the QIAcube Connect MDx for more details. Using the original package minimizes the possibility of damage during transportation of the QIAcube Connect MDx.

4.3 Installing the QIAcube Connect MDx

This section describes important actions that must be performed before operating the QIAcube Connect MDx. These actions include:

- Removal of the QIAcube Connect MDx accessories and shipping material.
- Installation of the AC power cord.
- Installation of external barcode scanner
- Installation of the centrifuge rotor and buckets.
- If an installation qualification (IQ/OQ) is required in your laboratory setup, this service can be ordered together with the instrument. For details, please contact QIAGEN Technical Service.

4.3.1 Removal of the QIAcube Connect MDx accessories and shipping material

1. Remove the power cord, barcode scanner and quick-start guide from the foam packing material on top of the QIAcube Connect MDx.
2. Remove the USB flash drive, rotor key, rotor nut, Allen key, S2 shaker adapter and shaker rack plugs from the waste drawer.
3. Carefully peel off the protective film from the QIAcube Connect MDx hood.

- To remove the foam protector around the robotic arm, gently pull the foam protector towards you (see picture below). After removing the protector for the robotic arm, make sure to close the QIAcube Connect MDx hood.



Foam protector for robotic arm.

4.3.2 Installation of AC power cord

- Remove the power cord from the foam packing material on top of the QIAcube Connect MDx.
Note: Only use the power cord that is supplied with the QIAcube Connect MDx.
- Ensure that the power switch is set to OFF: outer position is OFF and inner position is ON.
- Check that the voltage rating on the label at the back of the QIAcube Connect MDx matches the voltage available at the installation site.
- Plug the power cord into the instrument power-cord socket.
- Plug the power cord into a grounded power outlet.

<p>WARNING</p> 	<p>Damage to electronics [W9]</p> <p>Before powering ON the instrument, make sure that the correct supply voltage is used.</p> <p>Use of incorrect supply voltage may damage the electronics.</p> <p>To check the recommended supply voltage, refer to the specifications indicated in the type plate of the instrument.</p>
---	---

<p>WARNING</p> 	<p>Electrical hazard [W8]</p> <p>Any interruption of the protective conductor (earth/ground lead) inside or outside the instrument or disconnection of the protective conductor terminal is likely to make the instrument dangerous.</p> <p>Intentional interruption is prohibited.</p> <p>Lethal voltages inside the instrument</p> <p>When the instrument is connected to line power, terminals may be live and opening covers or removing parts is likely to expose live parts.</p>
---	--

4.3.3 Installation of external barcode scanner

1. Remove the barcode scanner from the box.
2. Plug the USB connector of the scanner into one of the USB ports located on the left of the QIAcube Connect MDx touchscreen.

4.3.4 Installing the centrifuge rotor and buckets

The centrifuge rotor and buckets are pre-installed in the QIAcube Connect MDx. When setting up the QIAcube Connect MDx for the first time, switch on the instrument (see section 5.2, Switching the QIAcube Connect MDx on and off) and remove the transportation foam inserts from the centrifuge after it opens. In case the centrifuge rotor and buckets have been manually removed (e.g., during maintenance), follow the instructions below to re-install them.

1. The rotor can be mounted in only one orientation. The pin on the rotor shaft fits into a notch on the underside of the rotor directly underneath rotor position 1.
2. Line up position 1 of the rotor with the pin on the rotor shaft and carefully lower the rotor onto the shaft.
3. Install the rotor nut on top of the rotor and tighten securely using the rotor key supplied with the QIAcube Connect MDx. Make sure that the rotor is securely seated. If the rotor nut is not tightened properly, it can become loose during operation of the centrifuge and can cause serious damage to the instrument. Such damage is not covered by the warranty.
4. Insert the rotor buckets. The side of the rotor bucket that must face toward the rotor shaft is marked with a grey line. Hold the bucket at an angle with the grey line facing the center of the rotor and hang the bucket on the rotor. Check that all buckets are properly suspended and can swing freely.

Important: All centrifuge buckets must be mounted before starting a run.

Before starting next protocol run, follow the instructions in section 6.6.3, Operating the centrifuge after cleaning.

<p>WARNING</p> 	<p>Risk of personal injury and material damage [W25]</p> <p>To prevent the rotor nuts from loosening during operation of the centrifuge, securely tightened the nuts using the rotor key supplied with QIAcube Connect MDx.</p>
---	--

WARNING 	Risk of personal injury and material damage [W20] Raise the centrifuge lid carefully. The lid is heavy and may cause injury if it falls.
---	--

CAUTION 	Damage to the instrument [C7] The QIAcube Connect MDx must not be used if the centrifuge lid is broken, or if the lid lock is damaged. Make sure that no loose material is inside the centrifuge during operation. Make sure that the rotor is installed correctly and that all buckets are properly mounted, regardless of the number of samples to be processed. Load the rotor only as instructed by the software. Only use rotors, buckets, and consumables designed for use with the QIAcube Connect MDx. Damage caused by use of other consumables will void your warranty. We recommend replacing the centrifuge rotor and buckets after 20,000 cycles, which is equivalent to 9 years of usage with two runs per day for 220 days each year. For more information contact QIAGEN Technical Services.
---	--

4.3.5 Installing the shaker adapter

A shaker adapter must be installed before the shaker can be used. Two types of shaker adapter are available:

- Adapter for 2 ml microcentrifuge safe-lock tubes (marked with "2")
- Adapter for 2 ml screw-cap tubes (marked with "S2").

The QIAcube Connect MDx is delivered with the shaker adapter for 2 ml microcentrifuge safe-lock tubes already installed. If you need to install the shaker adapter for 2 ml screw-cap tubes, follow these steps:

1. Remove the shaker rack.
2. Remove the shaker adapter for 2 ml microcentrifuge safe-lock tubes by unscrewing the retaining screws. Use the Allen key supplied with the QIAcube Connect MDx.
3. Place the shaker adapter for 2 ml screw-cap tubes onto the shaker.
4. Tighten the 2 retaining screws using the Allen key.

Note: Make sure to use the correct adapter as displayed on the touchscreen during run setup. This helps to ensure optimal instrument performance. Using an incorrect shaker adapter can adversely affect pipetting performance and protocol results.

4.4 Configuration of the QIAcube Connect MDx

When using the QIAcube Connect MDx for the first time, it is recommended to define the required settings. Other settings can be made later when needed.

For details on using the touchscreen and software, refer to section 5.1, QIAcube Connect MDx software.

To configure the QIAcube Connect MDx, follow the steps below.

1. Close the instrument hood.
2. Press the power switch to the inner position to power ON the instrument. The startup screen appears and the beeper sounds (if enabled in the sound settings). The instrument automatically performs the initialization tests. If the centrifuge lid is closed, it will open.
3. Initially, only one user account is available: the pre-installed default user. Press **OK** on the touchscreen to confirm the message.
4. Initially, if no maintenance has been recorded yet, the maintenance status is initialized using a default file. Press **OK** to confirm the message.
5. The **Login** screen appears after the initialization.

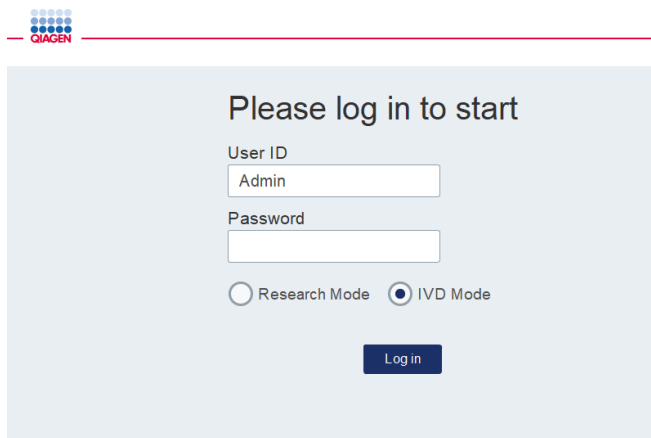

Login screen

6. Initially, only one default user is available. In this case, enter **Admin** in both the **User ID** and **Password** fields using the on-screen keyboard. Touch in the entry field to open the on-screen keyboard. For details, refer to section 5.1, QIAcube Connect MDx software, on how to enter text or numbers. In addition, please select which software mode (IVD or Research) to launch.

For details on software modes, please refer to section 5.1, QIAcube Connect MDx software.
After the first login, the system will ask you to change the password for User Admin.

7. Press **Log in**. The **Setup** screen appears.



Setup screen

8. If you need to return to the **Setup** screen from another screen, press the **Setup** icon ().

4.4.1 System configurations

This section describes how to set the following system configurations:

- Name for the QIAcube Connect MDx
- Current date and time
- System language

These settings can only be made by users with Administrator role. When using the QIAcube Connect MDx for the first time, it is recommended to set the current date and time.

Important: Changes to the system configurations performed in the Research mode of the software will be automatically applied as well in the IVD mode of the software.

1. On the menu bar, press the **Configuration** icon (⚙️).
2. Press the **System** tab. This tab is only available for users assigned the Administrator role.

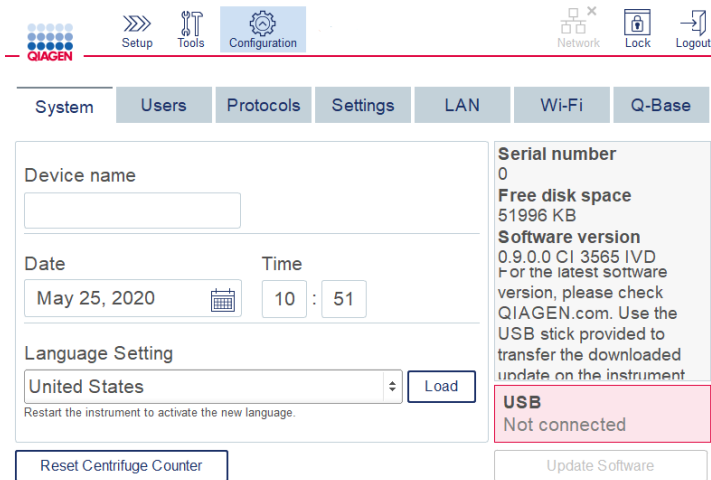

System configuration screen

3. Optionally, enter a name for the QIAcube Connect MDx. The device name serves as the network/host name when connecting the instrument to the network.
The name can have up to 24 characters: letters A–Z, a–z, digits 0–9 and a hyphen (-).
The name must start with a letter and cannot end with a hyphen (-).
4. In the **Date** and **Time** fields, select the current date and enter the current time for the instrument. These are used to track the start and end time of a run and are also part of the run report. Date and time are not synchronized using the network. To change the date, touch the calendar icon (📅) and select the date.
5. Use the left and right arrow icons to change the month. Then, touch the current day and press **OK** to confirm.

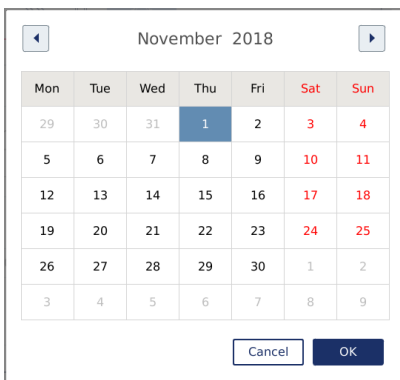

Calendar window with date picker

6. In the **Language Setting** field, a selection of languages is available according to countries local requirements. Select the language of your choice in the drop-down menu to run the software in a translated version. A restart of the instrument is necessary to activate the new language setting.
7. Additional language packages can be uploaded as they become available, via the **Load** button. A language package consists of the translation of the Graphical User Interface and translated protocols. The upload of a new language package is a two-step process. First, the translated Graphical User Interface is uploaded via the **Load** button. Next, the translated protocols need to be uploaded by following the instructions in section 5.11.1 (Installing new protocols). For more details, contact QIAGEN Technical Services.

4.4.2 Settings configuration

This section describes the optional settings that can be defined by each user:

- Audio volume
- Display brightness
- Internal light

The settings apply to the current user.

1. On the menu bar, press the **Configuration** icon (⚙️).
2. Press the **Settings** tab. This tab is available for all users.

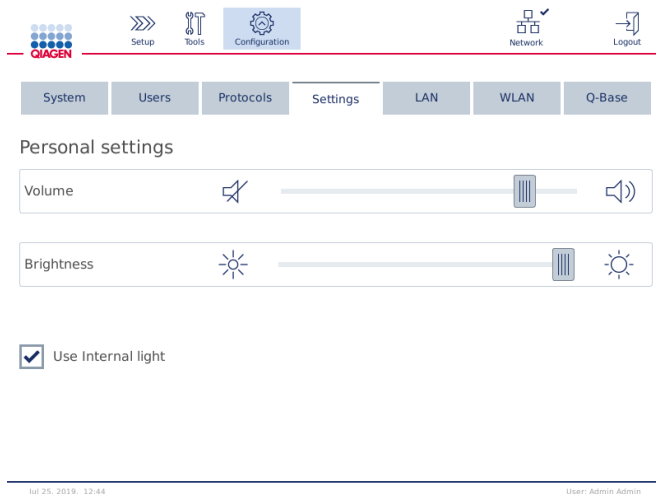

Settings screen

3. To adjust the audio volume or display brightness, touch the desired position on the virtual slider on the screen. For audio volume, a sound is played with the set volume.

4. Check the box next to **Use internal light** to turn on the LED light inside the instrument. Uncheck the box to turn it off.
5. To return to the Setup screen, press the **Setup** icon (.

4.4.3 Network configuration

The QIAcube Connect MDx can be connected via intranet, allowing real-time status monitoring on a computer or a mobile device (e.g., a tablet). This configuration requires connecting the QIAcube Connect MDx as well as the QIASphere Base (delivered with the QIASphere Connectivity Package – see section 10, Appendix B - QIAcube Connect MDx Accessories) to your network. This section describes how to connect the QIAcube Connect MDx instrument to your network, either by LAN or Ethernet cable, or by wireless connection. For more details on the QIASphere Base network configuration and how to connect both devices with each other, refer to the QIASphere Base user manual which is available at www.qiagen.com.

Important: The QIASphere Base communicates with the newly launched QIASphere App, and it also communicates with QIASphere cloud. The QIASphere App helps to monitor the instrument status, e.g., instrument is running; instrument is available or the instrument requires maintenance. If your QIASphere Base is connected to the QIASphere cloud, run reports generated by the QIAcube Connect MDx (including sample IDs) are transferred to the QIASphere cloud. In case this transfer of information would not be in accordance with your local regulations or with your laboratory regulations, the connection between the QIASphere Base and the QIASphere cloud needs to be actively deactivated. To disconnect the connection between the QIASphere Base and the QIASphere cloud, refer to the instructions provided in the QIASphere User Manual.

Only users assigned the role Administrator can change the network configuration. It is recommended to consult your network administrator when configuring the network. For communication with QIASphere Base, the outbound TCP port 443 (https) is used; ping is supported.

Configuring a wired network connection

1. Connect the QIAcube Connect MDx to a local area network (LAN) by using an Ethernet cable and the RJ45 Ethernet Port on the rear side of the QIAcube Connect MDx.
2. On the menu bar, press the **Configuration** icon (.
3. Press the **LAN** tab.

- To automatically configure the network via DHCP, check the **DHCP enabled** box. Leave all fields empty when using this setting. The assigned IP address will be displayed below the box.

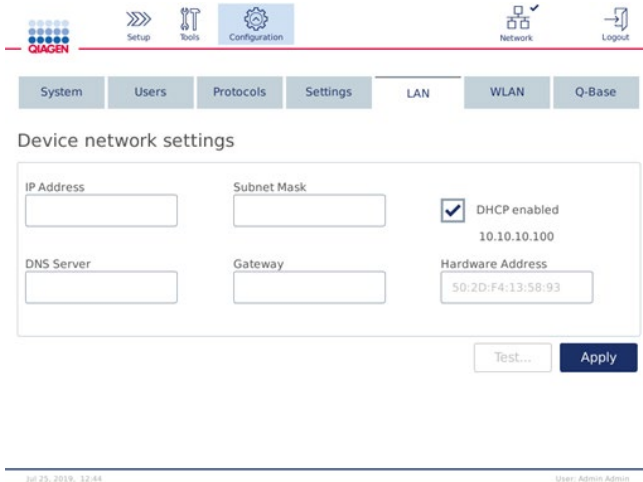

Device network settings screen

- To manually configure the network, uncheck the **DHCP enabled** box. Enter the **IP address**, **Subnet mask** and **Gateway** in the respective fields, using the IPv4 format shown in the picture above. Entering the **DNS server** is optional. These settings will not be validated by the QIACube Connect MDx.

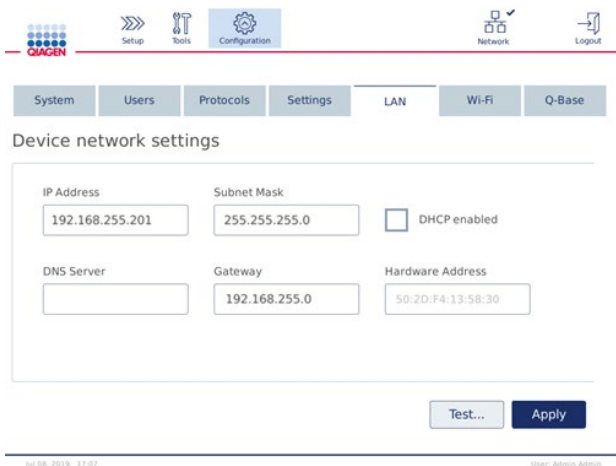

Device network settings screen with manual network configuration entries

- Press **Apply** to confirm and save the settings made.

Configuring a wireless connection

The QIAcube Connect MDx supports only WPA-PSK and WPA2-PSK. Additionally, the SSID of the Wi-Fi network must be visible. Connection to a hidden SSID is not supported.

Before Wi-Fi can be configured, the Wi-Fi USB device supplied with the QIAcube Connect MDx must be plugged into one of the USB ports behind the touchscreen.

Important: Always turn off the QIAcube Connect MDx before you plug in or unplug the Wi-Fi USB device. Plug-and-play of the Wi-Fi USB device while the instrument is turned on is not supported.

1. On the menu bar, press the **Configuration** icon (⚙️).
2. Press the **Wi-Fi** tab.
3. Press **Scan** to scan for available networks. The networks are listed based on their signal strength.

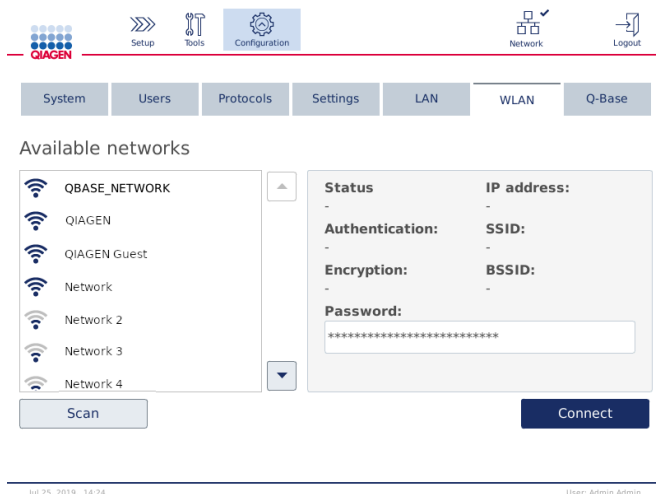

Available networks screen

- Select one of the available networks from the list. The details for the selected network are shown at the right.

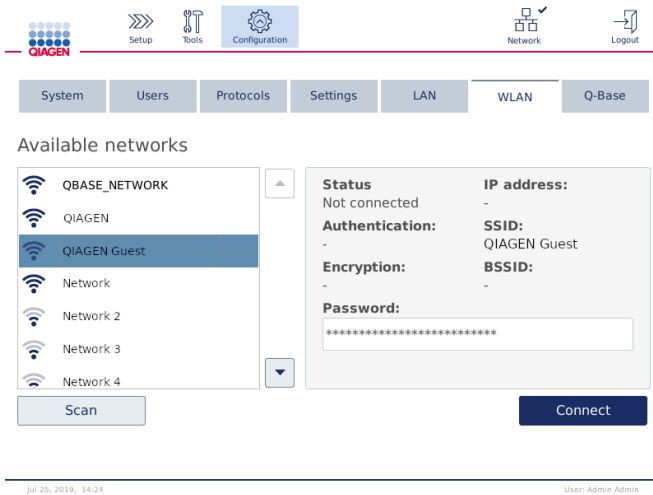

Available networks screen before network connection

- Enter the wireless network password and press **Connect** to connect to the network. The connected network is marked in the list.

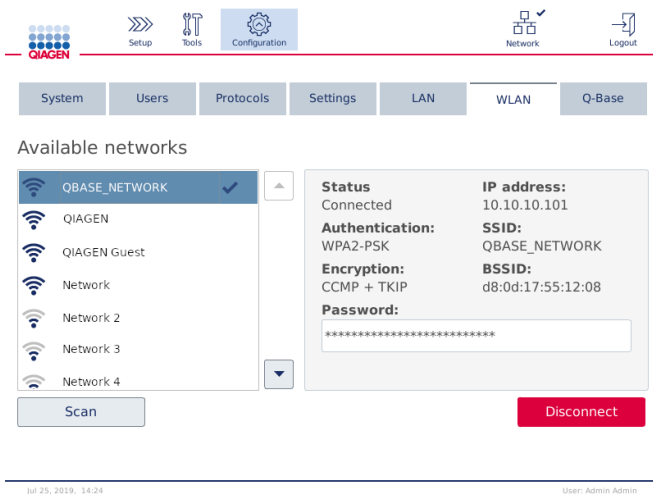

Available networks screen with established wireless network connection

Note: If a network is previously configured and a connection is established successfully at least once, the instrument will connect to that network automatically.

- To disconnect from Wi-Fi press **Disconnect**.

4.5 Packaging and transporting of the QIAcube Connect MDx

WARNING 	Risk of personal injury and material damage [W2] The QIAcube Connect MDx is too heavy to be lifted by one person. To avoid personal injury or damage to the instrument, do not lift the instrument alone.
---	---

Before transporting the QIAcube Connect MDx, the instrument must first be decontaminated. Refer to section 6.8, Decontaminating the QIAcube Connect MDx for more details. Then prepare the instrument as follows:

1. Prepare the packing material. Materials required are the cardboard carton, the pallet with foam blocks, the foam lid and the foam protector for the robotic arm.
Note: The centrifuge lid must be open to allow access to the inside of the centrifuge. If the lid is not open, perform steps 2–5 below. If the lid is already open, proceed to step 6.
2. Close the instrument hood.
3. On the menu bar, press the **Tools** button.
4. In the **Tools** menu, press the **Run Modules** tab.
5. In the **Run Modules** menu, press the **Centrifuge** tab and then press **Open Centrifuge Lid**.
6. Undo the rotor nut on top of the rotor using the rotor key, and carefully lift the rotor off the rotor shaft.
7. Close the hood.
8. On the menu bar, press the **Tools** button.
9. In the **Tools** menu, press the **Run Modules** tab.
10. In the **Run Modules** menu, press the **Centrifuge** tab and then press **Close Centrifuge Lid**.
11. When the centrifuge lid is closed, power OFF the QIAcube Connect MDx and open the hood.
12. Insert the foam protector into the front of the instrument.
13. Press the foam down between the centrifuge and the robotic arm.



Foam protector inserted between the centrifuge and the robotic arm

14. Push the foam until the rear end touches the back wall of the instrument. Ensure that the arm is held firmly in place and cannot move.
15. Make sure that the QIAcube Connect MDx hood can be closed properly. The hood should lightly brush against the foam.
16. Place the accessories into the waste drawer. The following accessories should be packed in air cushion bags:
 - Rotor key
 - Allen key
 - Rotor nut
 - USB flash drive
 - WLAN module
 - Shaker rack plugs
 - Shaker adapter
17. Place the handheld scanner into dedicated handheld scanner box.
18. Place the QIAcube Connect MDx onto the pallet and put the black foam lid over the top of the instrument. Place the box onto the instrument.

Important: When lifting the QIAcube Connect MDx, slide your fingers under both sides of the instrument and keep your back straight.

Important: Do not hold the touchscreen display while lifting the QIAcube Connect MDx, as this might damage the instrument.

<p>WARNING</p> 	<p>Risk of personal injury and material damage [W2]</p> <p>The QIAcube Connect MDx is too heavy to be lifted by one person. To avoid personal injury or damage to the instrument, do not lift the instrument alone.</p>
---	--

19. Place the accessories into the black foam lid. The following accessories should be packed in air cushion bags:
 - Rotor with swing-out buckets
 - Power cord
20. Seal the outside edges of the carton with tape to protect against moisture.

Note: Using the original package minimizes potential damage during transportation of the QIAcube Connect MDx.

5 Operating Procedures

This section describes how to operate the QIAcube Connect MDx.

Before proceeding, we recommend that you familiarize yourself with the features of the instrument by referring to section 3.2, External features of the QIAcube Connect MDx, and section 3.3, Internal features of the QIAcube Connect MDx.

Important: The QIAcube Connect MDx is designed for use with QIAGEN spin columns only. Geometry of spin columns manufactured by other suppliers may not be compatible with the QIAcube Connect MDx.







CAUTION 	Damage to the instrument [C2] Only use QIAGEN spin columns and QIAcube Connect MDx specific consumables with the QIAcube Connect MDx. Damage caused by use of other types of spin columns or chemistries will void your warranty.
---	--

The hood of the QIAcube Connect MDx must remain closed during operation of the instrument. Only open the hood when instructed to do so by the software.

WARNING 	Moving parts [W18] To avoid contact with moving parts during operation of the QIAcube Connect MDx, the instrument must be operated with the hood closed. If the hood sensor or lock is not functioning correctly, contact QIAGEN Technical Services.
---	--

WARNING 	Risk of personal injury and material damage [W3] Do not attempt to move the QIAcube Connect MDx during operation.
---	--

WARNING 	Risk of personal injury and material damage [W1] Improper use of the QIAcube Connect MDx may cause personal injuries or damage to the instrument. The QIAcube Connect MDx must only be operated by qualified personnel who have been appropriately trained. Servicing of the QIAcube Connect MDx must only be performed by a QIAGEN Field Service specialist.
---	--

<p>WARNING</p> 	<p>Risk of personal injury and material damage [W4]</p> <p>Do not use damaged rotor adapters. The rotor adapters can only be used once. High g forces exerted in the centrifuge can cause damage to used rotor adapters.</p>
<p>CAUTION</p> 	<p>Damage to the instrument [C3]</p> <p>Empty the tip disposal container prior to use to prevent a tip jam in the waste drawer. Failure to empty the waste container may block the robotic arm that could cause run failure or instrument damage.</p>
<p>WARNING</p> 	<p>Risk of personal injury and material damage [W5]</p> <p>To prevent plastic crash, load the tubes properly. After a plastic crash, sharp plastic particles could be inside the centrifuge. Be careful when handling items inside the centrifuge.</p>
<p>CAUTION</p> 	<p>Damage to the instrument [C4]</p> <p>Only use the correct volume of liquids.</p> <p>Exceeding the recommended volume of liquids may damage the centrifuge rotor or instrument.</p>
<p>WARNING</p> 	<p>Risk of fire or explosion [W6]</p> <p>When using ethanol or ethanol-based liquids on the QIAcube Connect MDx, handle such liquids carefully and in accordance with the required safety regulations. If liquid has been spilled, wipe it off and leave the QIAcube Connect MDx hood open to allow flammable vapors to disperse.</p>
<p>WARNING</p> 	<p>Risk of explosion [W7]</p> <p>The QIAcube Connect MDx is intended for use with reagents and substances supplied with QIAGEN kits or other than outlined in respective Information for use. Use of other reagents and substances may lead to fire or explosion.</p>
<p>CAUTION</p> 	<p>Damage to the instrument [C5]</p> <p>Do not lean against the touchscreen when it is pulled out.</p>

<p>WARNING</p> 	<p>Samples containing infectious agents [W12]</p> <p>Some samples used with this instrument may contain infectious agents. Handle such samples with the greatest of care and in accordance with the required safety regulations.</p> <p>Always wear safety glasses, 2 pairs of gloves, and a lab coat.</p> <p>The responsible body (e.g., laboratory manager) must take the necessary precautions to ensure that the surrounding workplace is safe, and that the instrument operators are suitably trained and not exposed to hazardous levels of infectious agents as defined in the applicable Material Safety Data Sheets (MSDSs) or OSHA*, ACGIH† or COSHH‡ documents.</p> <p>Venting for fumes and disposal of wastes must be in accordance with all national, state, and local health and safety regulations and laws.</p>
---	---

<p>WARNING</p> 	<p>Hazardous chemicals [W13]</p> <p>Some chemicals used with this instrument may be hazardous or may become hazardous after completion of the protocol run.</p> <p>Always wear safety glasses, gloves, and a lab coat.</p> <p>The responsible body (e.g., laboratory manager) must take the necessary precautions to ensure that the surrounding workplace is safe and that the instrument operators are not exposed to hazardous levels of toxic substances (chemical or biological) as defined in the applicable Material Safety Data Sheets (MSDSs) or OSHA,* ACGIH† or COSHH‡ documents.</p> <p>Venting for fumes and disposal of wastes must be in accordance with all national, state, and local health and safety regulations and laws.</p>
---	---

<p>WARNING</p> 	<p>Moving parts [W17]</p> <p>Avoid contact with moving parts during operation of the QIAcube Connect MDx. Under no circumstances should you place your hands under the robotic arm when it is lowering. Do not attempt to move any tip racks or tubes whilst the instrument is operating.</p>
---	--

<p>WARNING</p> 	<p>Hot surface [W21]</p> <p>The shaker can reach temperatures of up to 70°C (158°F). Avoid touching it when it is hot. Carefully remove the samples after a run.</p>
---	---

* OSHA : Occupational Safety and Health Administration (United States of America).

† ACGIH : American Conference of Government Industrial Hygienists (United States of America).

‡ COSHH : Control of Substances Hazardous to Health (United Kingdom).

WARNING/ CAUTION 	Risk of personal injury and material damage [W22] Only perform maintenance that is specifically described in this user manual.
--	--

5.1 QIAcube Connect MDx software

The QIAcube Connect MDx gives the option to start a protocol either in the IVD mode of the software (validated IVD applications only) or in the Research mode of the software (Molecular Biology Applications (MBA) and customized protocols only). The usage of IVD protocols is only possible and strictly restricted to the IVD mode of the software. This User Manual focuses on operating the QIAcube Connect MDx in the IVD-software mode. For detailed instructions on how to operate the QIAcube Connect MDx using the Research mode of the software, please refer to the **User Manual of the QIAcube Connect** (available on the QIAcube Connect product webpage under the **Product Resources** tab).















To change the software mode, the user must first log out from the current software mode before logging in to another mode. At the bottom of the touchscreen, the system shows which software mode is in use.

The QIAcube Connect MDx is operated through a touchscreen, which guides you step-by-step through the correct loading of the work deck and selection of the protocol.

Note: The instrument's touchscreen does not support swiping and multi gestures.

General functions of the QIAcube Connect MDx touchscreen are described below.

Note: A red light on the pressed button indicates a longer reaction time.

Button/Icon	Function
	Enables the user to scroll up through a list.
	Enables the user to scroll down through a list.
	The software automatically proceeds to the next screen.
	Returns to the previous screen.
	Returns to previous screen without saving any changes.
	Enables the user to change certain settings (e.g., to edit a user account).
	Enables the user to delete certain settings (e.g., to delete a user).
Text fields	Enables to edit text or value. A pop-up keyboard enables these changes.
Row in tables	Can be pressed to select the respective row. Either item will be selected, or row will be highlighted.
	Press to show additional information to respective item
	Press to show important information that must be followed during run setup for respective item.
 Sample information ...	Press to show additional information to respective item
 Sample information ...	Press to show important information that must be followed during run setup for respective item.
	Navigation back to the Setup screen
	Tools/Maintenance functions
	Configuration
	Log out from the instrument

Touchscreen buttons and icons overview for general use

To enter text or numbers, touch the respective field. The corresponding on-screen keyboard will be displayed.



Keyboard for entering a password

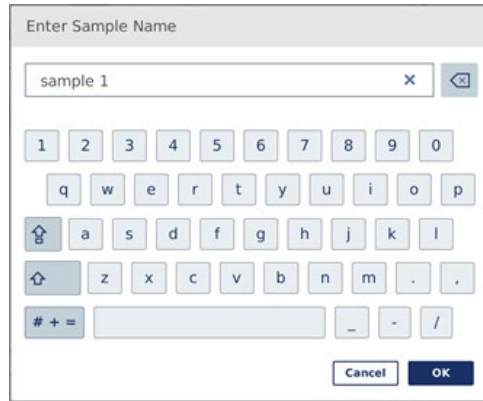



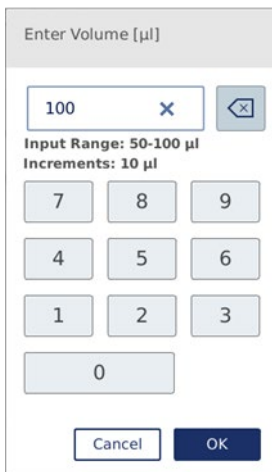





Keyboard for entering a sample name



Keyboard for editing a protocol parameter

For protocol parameters, the value range is displayed. In the example shown in the screenshot above, values from 50–100 µl can be entered, but only in steps of 10 µl. If the entered value is not correct, the field border will change to red. It is not possible to proceed to the next screen in this case. Press the field again and correct the value according to the range displayed next to the field.

Buttons and icons in the on-screen keyboard are described below.

Button/Icon	Function
	Remove character to the left.
	Clear all from the field.
	To type the next letter in upper-case. After the letter has typed, the keyboard will show lower-case letters again.
	Switch to upper-case letters. Allows to type a number of upper-case letters. Press the symbol again to return to lower-case letters.
	Show special characters.
	Return to letters.
	Confirm and close.
	Discard and close.

Touchscreen buttons and icons in the on-screen keyboard

5.2 Switching the QIAcube Connect MDx on and off

Switching on the QIAcube Connect MDx

1. Close the instrument hood.
2. Switch on the instrument by pressing the power switch to the inner position. You will hear a sound (if sound settings are enabled), and a startup screen appears. The instrument automatically performs initialization tests. If the centrifuge lid was closed, it will open.

Switching off the QIAcube Connect MDx

1. Switch off the instrument by pressing the power switch to the inner position.
Note: After powering OFF the QIAcube Connect MDx, you must wait for a few seconds before you power ON the instrument again. The system might fail to start if you do not allow the QIAcube Connect to rest for a few seconds before powering ON.

5.3 Logging in and Logging out

Logging in

1. Close the instrument hood.
2. Switch on the instrument.

After the initialization is complete, the **Login** screen appears.

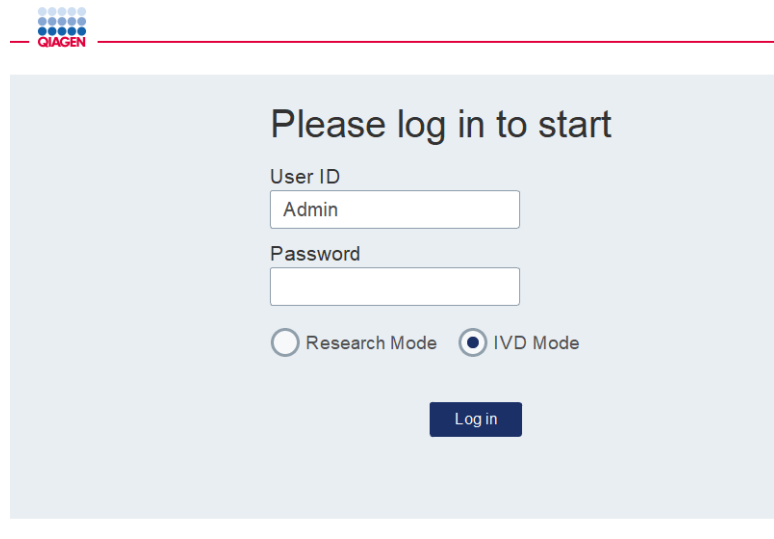

QIAGEN

Please log in to start

User ID
Admin

Password

Research Mode IVD Mode

Log in

Login screen

3. Enter **User ID** and **Password** using the on-screen keyboard.
4. Select software mode (IVD or Research).
Note: The selected software mode is shown at the bottom of the screen as long as you are logged in.
5. Press **Log in**.
6. The **Setup** screen appears.

In case of a failed login, an exclamation icon (❗) and information screen will appear. Touch the respective field to enter the **User ID** and **Password** again, ensuring that you enter the information correctly. The **User ID** is case sensitive.

A screenshot of a login screen with a light blue background. At the top, the text "Please log in to start" is displayed. Below this are two input fields: "User ID" containing the text "Admin" and "Password" containing a single black dot. Underneath the password field are two radio buttons: "Research Mode" (unselected) and "IVD Mode" (selected). A red-bordered box with a white background contains a red exclamation icon and the text "You have entered wrong credentials." At the bottom center is a dark blue button labeled "Log in".

Information screen from failed login, for example, due to entering incorrect password

Logging out

1. Press **Logout** at the top right of the screen.
2. To log out, confirm the message with **OK**. To stay logged in, press **Cancel**.
Note: The system will log out automatically if you are inactive for a certain time.
The administrator can set the number of minutes before automatic logout.
3. The login screen appears.
Note: In case of automatic log out, only the same operator who previously used the instrument or an administrator can log in again.

5.4 Setting up a protocol run

Commonly used QIAGEN standard protocols (Life Science and DSP protocols) are installed on the QIAcube Connect MDx upon delivery. Available QIAGEN IVD-protocols can be downloaded from the **Product Resources** tab of the QIAcube Connect MDx product page: <https://www.qiagen.com/products/qiacube-connect-mdx>.

For instructions on installing downloaded protocols see section 5.11.1, Installing new protocols.

Important: Before starting any protocol, thoroughly read the relevant QIAGEN kit handbook.

Protocol setup starts from the Setup screen. The touchscreen software will guide you through the protocol run setup and worktable loading steps. The display screens vary depending on the protocol in use and may look different from the screens shown in this section.

Note: If you need to pause the setup, click the lock icon on the main screen. To unlock the screen, you need to enter your credentials. Only the same operator who previously used the instrument or an administrator can unlock the screen.

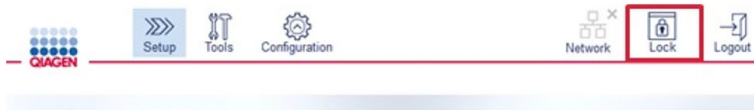

Lock button on main screen

1. Prepare the samples to be processed using the protocol indicated in the protocol selection screen. Refer to the kit handbook for more information, if required. The needed sample pretreatment can be found in the respective kit handbooks.
2. To start the run setup in the IVD mode, scan the 2-D bar code of the QIAGEN kit. Press **Scan Kit** and then use the handheld scanner. It is also possible to just scan the bar code without pressing **Scan kit**.

The following information from the kit barcode will be added to the run report created at the end of the run:

- the kit name
- the material number
- the lot number
- the expiry date
- if the kit is expired (using an expired kit, the run will be flagged as **Invalid**).

Note: Only use QIAGEN IVD kits within their expiration date. The run is not anymore valid if you use a kit with an expired shelf life, and accordingly, the run results cannot be used for diagnostic use.

Also, it is not recommended to start a run at the end of the day (**overnight run**) and collect the eluates on the next day. As the QIAcube Connect MDx has no technical capability to cool the eluates after the completion of a run, the quality of the eluates might be compromised after a longer storage time at room temperature.

If scanning of the kit barcode fails, you can also type the kit barcode via the user interface. The code is structured as follows:

Position	Length	Value	Description
1 to 2	2	01	Identifier "GTIN"
3 to 16	14		GTIN, not used by the system, see label
17 to 18	2	17	Identifier "Expiry date"
19 to 24	6		Expiry date (YYMMDD), see label. If not used: 000000
25 to 26	2	10	Identifier "Lot"
27 to "]"	4 to 10		Lot number, variable length, see label
	1]	Marker for the end of the lot number
	3	240	Identifier "Product code"
after "240"	0 to 15		Material number (REF), either contains a catalog number or a material number, see label.

Kit barcode structure

The sample barcode label below means that for this label, the barcode string would be **010405322800290117181231101151234567]24061704:**

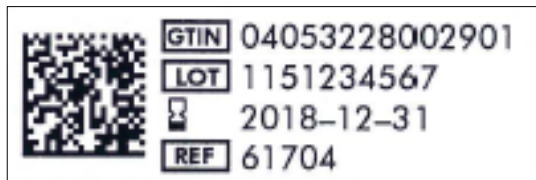

Example of kit barcode label

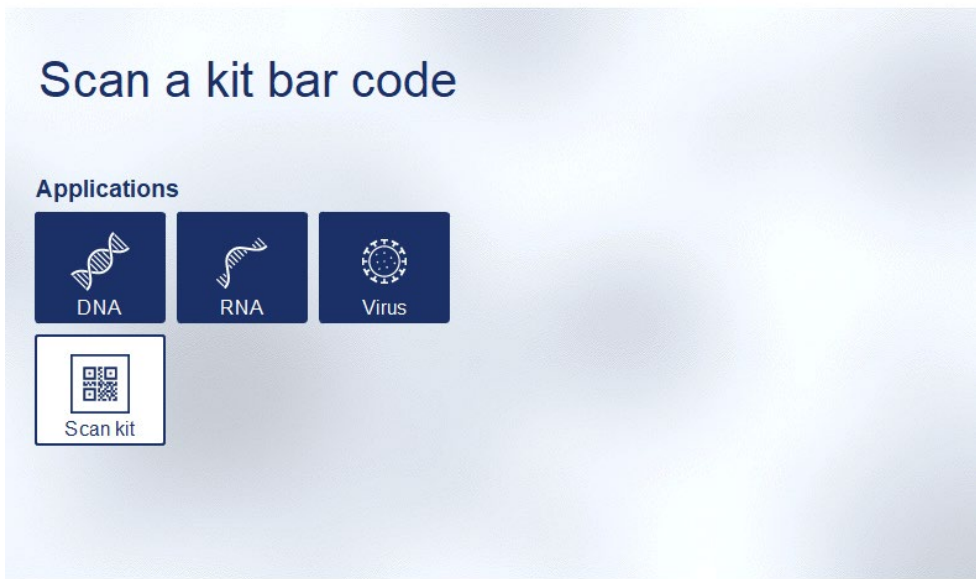

Setup screen

The software will automatically proceed to the next screen. Depending on the scanned kit bar code, the software may skip the **Material** and/or **Protocol Selection** screens. The software will skip the selection screen if the required information is provided by kit bar code scanning.

- To enter information in the next screens, follow the instructions provided in the sections below. Depending on your selections, the number and order of the screens displayed on your instrument may vary.

Each section below contains a screenshot image. Follow the instructions in that section with the corresponding screen displayed on your instrument.

In general, press **Next** to proceed to the next screen, or press **Back** to return to the previous screen. **Next** will only be active if all required information has been entered in the current screen.

Important: Do not use the **Next** button while the robotic arm is still moving.

Many screens have **Up** (▲) and **Down** (▼) arrow icons to scroll. Make sure to scroll all texts down to the end and follow the instructions completely.

5.4.1 Material selection

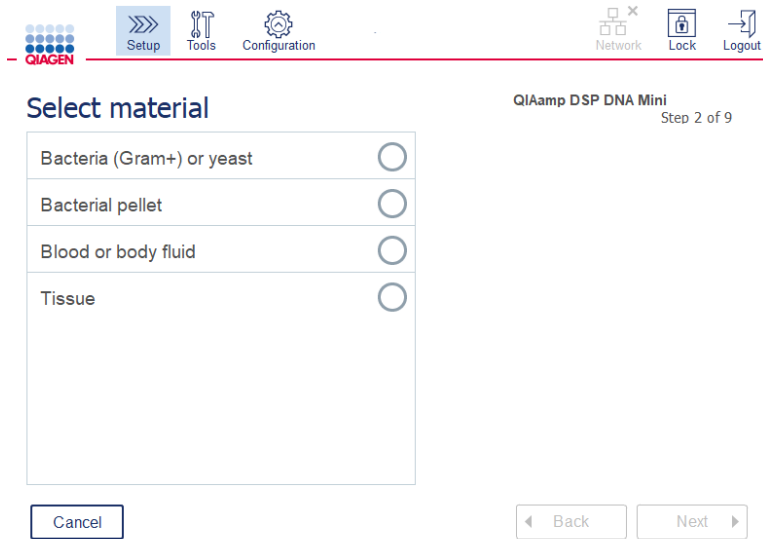

Select material screen

1. Select the sample material by touching the corresponding row. Only one sample material type can be selected per run.
2. Press **Next** to proceed to defining the protocol.

5.4.2 Protocol selection

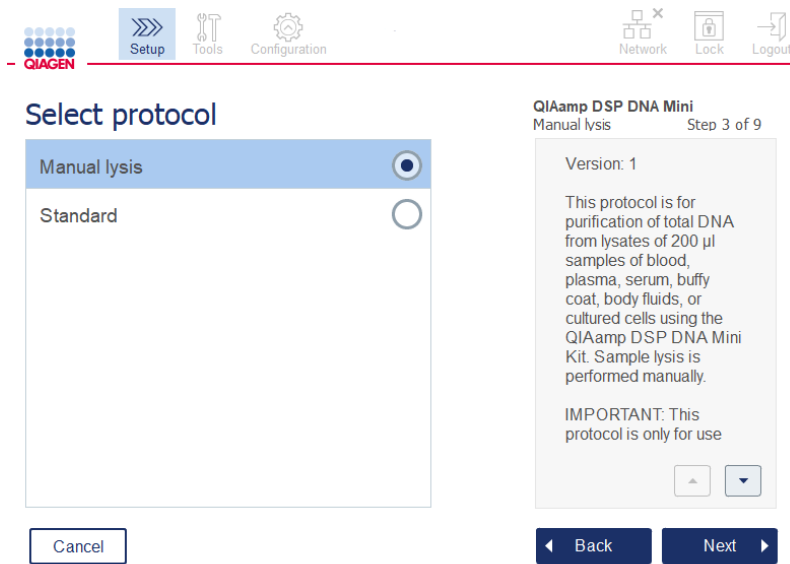

Select protocol screen

1. Select the protocol by touching the corresponding row. Only one protocol can be selected per run.
Important: Ensure to read all essential and critical information in the right pane (scroll down if necessary) before proceeding to the next step.
2. Press **Next** to proceed to defining the run parameters.

5.4.3 Parameter definition

Depending on the selected protocol, certain parameters must be defined. Some protocols do not allow the modification of parameters. These parameters are fixed as they are validated for the procedure. For protocols with editable parameters, default settings are defined, but can be changed. Follow the instructions in the information pane on the right regarding changing the values and which increments can be used.

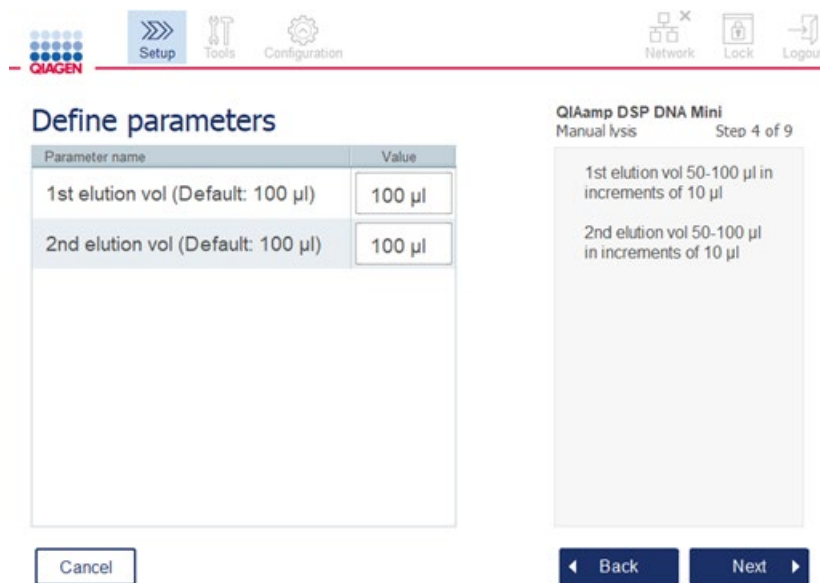

Define parameters screen

1. If required, press the **Value** field to change a parameter value using the on-screen keyboard. Refer to section 5.11.1, Installing new protocols, for details about the on-screen keyboard.
2. Press **Next** to proceed to defining the sample number. The software automatically proceeds to the next screen. Follow the instructions in the corresponding section below.

5.4.4 Sample number definition

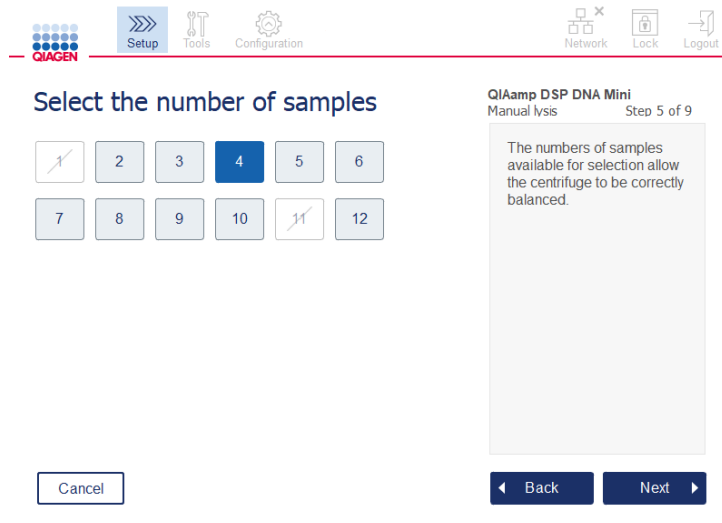

Define sample numbers screen

1. To select the number of samples for the run, press the corresponding number on the screen. Sample numbers (1 and 11) that would lead to a misbalance during centrifugation cannot be chosen.
2. Press **Next** to proceed to loading the reagents.

5.4.5 Loading buffer bottles



Load buffer bottles screen

The **Load buffer bottles** screen guides you through setting up the required buffers for the run. Make sure to read all essential and critical information before proceeding to the next step.

Note: To avoid run issues and to guarantee proper sitting of buffer bottle rack, the buffer bottle rack must be equipped with rack labeling strips.

Depending on the selected protocol, loading of buffer bottles might not be required. In this case, the software will indicate that this step can be skipped.

1. Prepare the reagents as shown on the screen. Refer to the respective kit handbook for further information and ensure that the correct buffers are used on each position (see the blue-shaded circle on the touchscreen). When pouring, ensure that the buffer does not foam or contain large air bubbles.

Note: Pour a volume of reagents as close as possible to the volumes required for the selected protocol and the respective number of sample processed (as indicated on the reagent table on the touchscreen).

Pos.	Name	Volume	Info
2	Buffer AL	≥ 5 ml	(i)
3	100% ethanol	≥ 5 ml	(i)
4	Buffer AW1	≥ 7 ml	(i)
5	Buffer AW2	≥ 7 ml	(i)
6	Buffer AE	≥ 5 ml	(i)

QIAcube Connect MDx User Manual 12/2020

Load buffer bottle screen circles the position on the buffer bottle rack for selected buffer in the list.

Before proceeding to the next step, ensure that you read all essential and critical information indicated in the **Information** icon ((i)) marked in red. Press the icon to open the information.

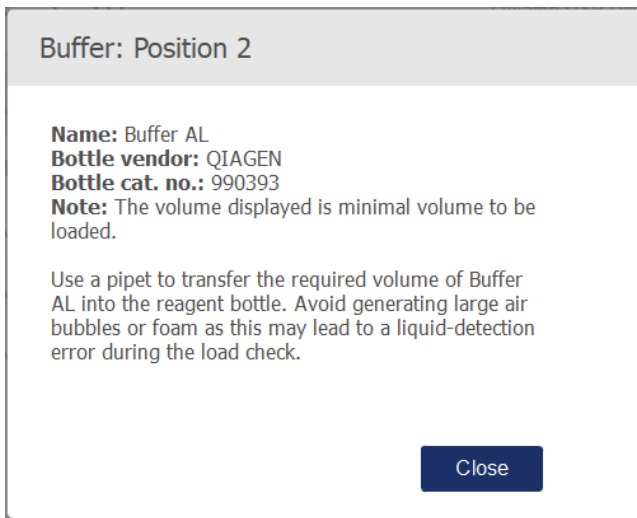

Example of message box displayed by hitting the information icon ().

2. Make sure that the buffer bottles contain the minimum volumes described in the **Volume** column. Each bottle can hold a maximum volume of 30 ml, but it is recommended not to use more than the minimal volume.
Later, when the run is started, the instrument will determine the filling volume. Ensure to label the buffer bottles properly and according to safety requirements. Buffer bottles can be stored according to the storage conditions described in the kit handbooks. However prolonged times of buffer bottles standing open on the instrument must be avoided. For subsequent runs, fresh buffer should be refilled. We recommend to reuse the buffer bottles only until one kit is used up. As soon as a new QIAGEN kit is opened, new buffer bottles should be used.
3. Place each opened buffer bottle in the correct position of the reagent bottle rack as shown on the screen. The buffer bottle rack positions are numbered for easy identification. The rack will only fit on the worktable if its orientation is correctly set.
4. Once all the buffer bottles are placed on the reagent bottle rack, place the rack on the worktable. Ensure that the rack is oriented correctly with number 1 on the top.
Important: Ensure to place the reagent bottle rack correctly into the designated worktable slot. Bottle racks that are in a leaning position could cause errors during liquid detection.
Important: Ensure that buffer bottles are open. A closed buffer bottle will be detected by the instrument and prevent the run from being started.
5. Press **Next** to proceed to loading the tips and enzymes. The software automatically proceeds to the next screen. Follow the instructions in the corresponding section below.

WARNING 	Risk of fire or explosion [W6] When using ethanol or ethanol-based liquids on the QIAcube Connect MDx, handle such liquids carefully and in accordance with the required safety regulations. If liquid has been spilled, wipe it off and leave the QIAcube Connect MDx hood open to allow flammable vapors to disperse.
---	---

5.4.6 Loading tips and enzymes

Important: When the **Loading tips and enzymes** screen appears, the robotic arm will automatically move slowly – even when the instrument hood is open – so you can access all of the loading positions. Always stand clear of the instrument while the robotic arm is moving. Wait until the robotic arm has completed its movements before you start to load or unload tip racks or enzymes. After you are finished loading and you proceed from this screen, the robotic arm will automatically move back to its original position (above tip rack position 3).

If more than one rack of the same tip type is loaded, the instrument will use the tip rack placed in position 1 first, then continue to position 2, and then position 3. To use a partially filled rack first, load it in position 1.

Depending on the selected protocol, loading of tips and enzymes might not be required. In this case, the software will indicate that this step can be skipped.

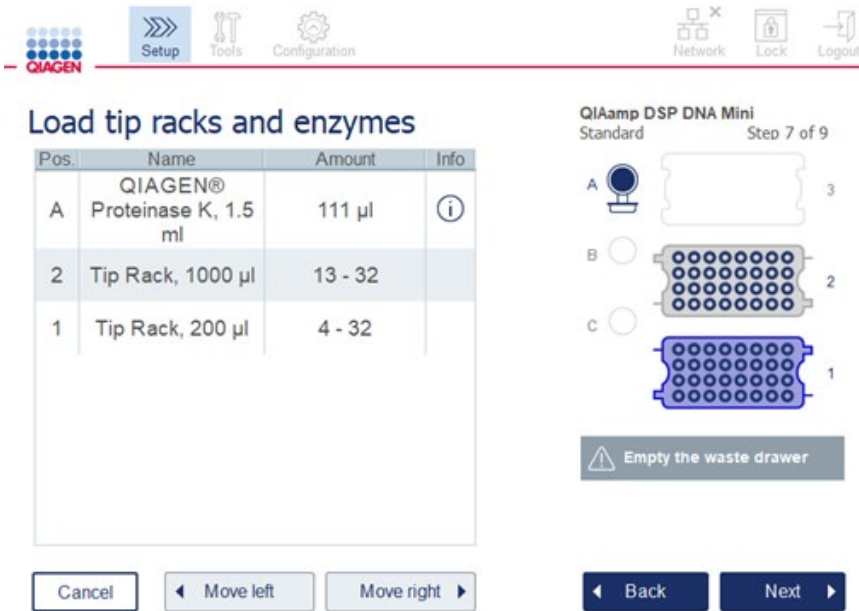

Pos.	Name	Amount	Info
A	QIAGEN® Proteinase K, 1.5 ml	111 µl	
2	Tip Rack, 1000 µl	13 - 32	
1	Tip Rack, 200 µl	4 - 32	

Loading tip racks and enzymes screen

If for any reason the robotic arm prevents you from reaching a loading position, do not move the robotic arm manually. Instead, proceed as follows:

- Press **Move left**. The robotic arm will start to move. The hood can remain open during this movement.
- Ensure that you stand clear of the instrument while the robotic arm is moving. Wait until the robotic arm has completed its movements.

Follow the instructions below to load enzyme, reagents and tips:

1. Prepare enzymes and/or reagent(s) listed on the screen. Refer to the corresponding kit handbook for more information. Before proceeding to the next step, make sure that you read all essential and critical information indicated in the **Information** icon (i) marked in red.
2. Make sure that you are using the correct tube type. Press the **Information** icon (i) in the respective row to show the details.
Supported enzyme tube types are 1.5 ml micro-centrifuge tube (Sarstedt®, Cat. no.: 72.706), 2 ml screw-cap tube without skirted base (QIAGEN, Cat. no.: 990382) and 2 ml Processing tube (QIAGEN, supplied with PAXgene Blood RNA Kit).
3. Make sure that you provide the correct volume as indicated on screen. The volume shown on the screen is the minimum volume to be loaded. To avoid spill-over during the run, do not exceed this volume significantly.
4. Place the opened tube in the worktable position as indicated in the table on the screen. It is important that you load the tube in the correct worktable position.
5. Place the lid of the microcentrifuge tube securely in the lid slot next to the tube.
6. Make sure that the required number of tips for each tip type are loaded as indicated on the screen. It is possible to use up the tip racks, if the minimum required number of tips for each type is loaded. However, it is recommended to load more than the minimum amount of tips.
The loading position shown on the screen is the recommended position for tip racks. The position can also be changed. Later, when starting the run, the instrument will check if the correct tip racks are placed on the worktable and if there are enough tips for the protocol run.
There are 3 different kinds of tip racks that can be used on the QIAcube Connect MDx, depending on the protocol selected. A blue rack for 200 µl filter-tips, a light grey rack for 1000 µl filter-tips and a dark grey rack for 1000 µl wide-bore filter-tips. The instrument uses the notches on the filter-tip rack to identify the type. To prevent mix up that may lead to a run issue, **do not manually refill tip racks**. Only use tips designed for use with the QIAcube Connect MDx.

Important: Do not use damaged filter tips. Do not load damaged tip racks onto the worktable.

Note: When using partially filled tip racks, consider the order in which the racks are loaded. The tip rack placed in position 1 will be used first.

7. Ensure that you empty the waste drawer containing used disposable labware before every run to avoid waste accumulation.
8. Press **Next** to proceed to loading the centrifuge or shaker rack, depending on the selected protocol.

Important: After loading and you proceed from the **Loading tips and enzymes** screen, the robotic arm will automatically move back to its original position (above tip rack position 3). Ensure to stand clear of the instrument while the robotic arm is moving. Wait until the robotic arm has completed its movements.

5.4.7 Loading the centrifuge

The **Loading centrifuge** screen guides you through setting up the required rotor adapters and centrifuge for the run. Make sure to read all essential and critical information before proceeding to the next step.

Depending on the selected protocol, loading of the centrifuge might not be required. In this case, the software will indicate that this step can be skipped.

Rotor adapters can be placed into a rotor adapter holder, enabling convenient and easy preparation and loading of columns. Place the columns, tubes or samples into the appropriate positions in each rotor adapter as instructed by the software. Ensure to label the elution tubes with the sample ID.

For some protocols (e.g. PAXgene Blood RNA Kit), the software might instruct you to cut off the lid of a spin column for a certain rotor adapter position. Do this before loading the spin column. Be sure that the lid is completely removed from the spin column. Spin columns with partially removed lids may not be gripped properly by the robotic gripper, and may cause the protocol run to crash.



Column lid removed incorrectly; part of the lid is still remaining

Column lid removed correctly

Comparing correct and incorrect removed column lids

If the protocol requires use of spin columns with screw caps (e.g., Qproteome Albumin/IgG Depletion Spin Columns), remove the screw cap from the spin column, and screw on a spin column adapter ring (not supplied with the QIAcube Connect MDx; see section 10, Appendix B - QIAcube Connect MDx Accessories) onto the column. The spin column adapter ring enables the robotic gripper to transfer the column during the purification procedure. Break off the bottom closure of the spin column before placing into the rotor adapter.



Mounting a spin column adapter ring.

Ensure that the tubes and spin columns have been pushed firmly into the appropriate rotor adapter position.

Place the lids into the correct lid position of the rotor adapter as indicated on your screen in the **Lid position** table column and the rotor adapter illustration. Make sure that the lids are pushed all the way down to the bottom of the slots on the sides of the rotor adapter. Incorrectly positioned lids can break off during centrifugation and cause the protocol run to crash.



1.5 ml microcentrifuge tube lid is in correct position



Correctly loaded rotor adapter. **A** Rotor adapter is correctly loaded, and the 1.5 ml microcentrifuge tube lid is in the correct position; **B** Correctly loaded rotor adapter seen from the side.



1.5 ml microcentrifuge tube lid not pushed down into slot







Incorrectly loaded rotor adapter. **C** Rotor adapter is incorrectly loaded with a 1.5 ml microcentrifuge tube. The lid of the tube is not pushed all the way down to the bottom of the slot of the rotor adapter and could break off during centrifugation (compare with part A of the above figure); **D** Incorrectly loaded rotor adapter seen from the side (compare with part B of the above figure).



1.5 ml microcentrifuge tube lid is in the wrong slot of the rotor adapter

Rotor adapter is incorrectly loaded with a 1.5 ml microcentrifuge tube. The lid of the tube is positioned in the wrong slot of the rotor adapter. During column transfer, the lid of the spin column could crash onto the lid of the 1.5 ml microcentrifuge tube, causing the protocol run to crash.

<p>WARNING</p> 	<p>Risk of personal injury and material damage [W5]</p> <p>To prevent plastic crash, load the tubes properly. After a plastic crash, sharp plastic particles could be inside the centrifuge. Be careful when handling items inside the centrifuge.</p>
<p>WARNING</p> 	<p>Risk of personal injury and material damage [W4]</p> <p>Do not use damaged rotor adapters. The rotor adapters can only be used once. High g forces exerted in the centrifuge can cause damage to used rotor adapters.</p>
<p>WARNING</p> 	<p>Risk of personal injury and material damage [W27]</p> <p>Make sure that lids from spin columns and 1.5 ml microcentrifuge tubes are in the correct position and pushed all the way down to the bottom of the slots on the sides of the of the rotor adapter. Incorrectly positioned lids can break off during centrifugation.</p>
<p>WARNING</p> 	<p>Risk of personal injury and material damage [W28]</p> <p>Be sure the lid is completely removed from the spin column. Spin columns with partially removed lids may not be removed properly from the rotor, causing the protocol run to crash.</p>

Depending on the selected protocol, samples can be loaded onto the shaker or directly into the centrifuge. Follow the instructions below the screenshot corresponding to your screen. Your screen may look different depending on the selected protocol.

Loading the centrifuge in case samples are loaded onto shaker

This section describes a workflow that includes the shaker unit (e.g., for lysis). Tubes with samples need to be loaded onto the shaker unit (refer to section 5.4.8, Loading the shaker), and the centrifuge must be prepared according the following description.

Load the centrifuge rotor adapter

QIAamp DSP DNA Blood Mini
Elution volume: 200 µl Step 8 of 9

Pos.	Labware	Lid position
1	QIAamp Mini spin column	L1
2	-	-
3	1.5 ml Elution tube	L3

4 x Rotor adapter

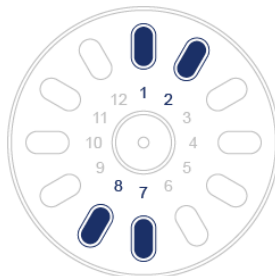

Label Elution Tubes with Sample ID or Rotor Position

Cancel

Back

Next

Aug 05, 2020, 12:53

Mode: IVD

User: a b

Load the centrifuge rotor adapter screen when samples are loaded onto the shaker. Position 2 of the rotor adapter is empty.

The number and tube positions of rotor adapters required for the protocol run will be shown in the table and illustration on your screen. The table shows how to load and position each rotor adapter. The **Pos.** column indicates the position in the rotor adapter, and the **Lid position** column indicates where to place the lid of a particular tube.

For each rotor adapter:

1. Load each tube/spin column in its correct position as indicated in the table on the screen.
Touch the table row to highlight the particular tube position in the illustration below the table.
2. Ensure that the tubes and spin columns are pushed firmly into the appropriate rotor adapter position.
3. Make sure that the lids are pushed all the way down to the bottom of the slots on the sides of the rotor adapter. Ensure that you place the lids in the correct lid positions.
4. Label the elution tubes with the same sample ID as the sample on the respective input position on the shaker (see section 5.4.8, Loading the shaker) or the rotor position number. Be sure to use a sticky label, which is safely attached.
5. If required and described in the table, cut off the lid, or screw on a spin-column adapter ring and break off the bottom of the spin column.
6. Repeat steps 1–5 until all rotor adapters have been prepared.

7. **As shown on the right side of the screen**, place the loaded rotor adapters into the centrifuge buckets. For ease of use and high process safety, the rotor adapters only fit into the centrifuge buckets in one orientation.
8. Press **Next** to proceed with loading the samples into the shaker. Follow the instructions in section 5.4.9, Loading the shaker. Depending on the selected protocol, the sequence of the next screens can be different.

Loading samples into the centrifuge

This section describes a workflow that does not include the shaker unit (e.g., for lysis). Samples are directly loaded into the centrifuge. For workflows including the shaker unit, refer to section 5.4.7, Loading the centrifuge in case samples are loaded onto shaker.

The procedures for loading samples into the centrifuge are shown on both sides of the screen. Such protocols are only available in the Research mode of the software.

Prepare the required number of rotor adapters as shown on the screen.

Pos.	Labware	Lid position
1	MB RNA spin Column	L1
2	450 µl sample	-
3	1.5 ml Elution tube	L3

6 x Rotor adapter

RNeasy PowerMicrobiome
IRT with DNase Step 9a of 9

Rotor Adapter Position for sample loading: 2

Lysis samples mechanically according to RNeasy PowerMicrobiome Kit instruction manual.

After centrifugation in step 4, Transfer at least 450 µl of sample into Rotor Adapter position 2 (Rotor Adapter Middle Position). If the sample volume is less than 450 µl, add Solution PM1 up to the final volume. Important: It is critical that you use Solution PM1 and not water to adjust the volume. Solution PM1 is available as an accessory product (cat. no. 26000-50-1).

User: Admin Admin

Load the centrifuge rotor adapter screen when samples are loaded into the centrifuge. Samples are loaded in position 2 of the rotor adapter.

The number and tube positions of the rotor adapters required for the run are shown in the table and in the illustration. The table shows how to load each rotor adapter. The **Pos.** column indicates the position in the rotor adapter, and the **Lid position** column indicates where to place the lid of a particular tube.

For each rotor adapter:

1. For samples: Prepare and load the samples as outlined on the screen. Make sure to load the correct sample amount. Ensure that you read all essential and critical information indicated in the blue **Information** box on the right side of the screen.
2. Load each tube/spin column in its correct position as indicated in the table on the screen. Touch the table row to highlight the particular tube position in the illustration below the table.
3. Ensure that the tubes and spin columns are pushed firmly into the appropriate rotor adapter position.
4. Make sure that the lids are pushed all the way down to the bottom of the slots on the sides of the rotor adapter. Ensure that you place the lids in the correct lid positions.
Note: If required and described in the table, cut off the lid, or screw on a spin-column adapter ring and break off the bottom of the spin column.
5. Repeat steps 1–4 until all rotor adapters have been prepared.
6. Load the rotor adapters into centrifuge. Place the prepared rotor adapters into the centrifuge buckets as shown on the right side of screen. For ease of use and safety, the rotor adapters fit in the centrifuge buckets in only one orientation. To prevent sample mix up, ensure to load the particular Sample ID into the defined centrifuge position.
7. If required, change the default value in the **Sample ID** fields using the on-screen keyboard. You can enter the value manually or scan the sample bar code using the external barcode scanner. The sample ID is initially created using the YYYYMMDD-HHMM-no. format. Be sure that the same ID can be found on the respective elution tube on a sticky label, which is safely attached.

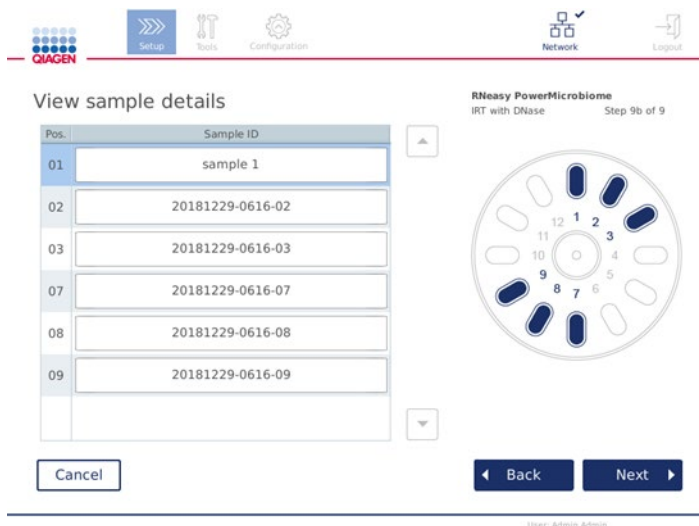

View sample details screen

Note: Sample IDs are part of the run reports and can be part of log files and audit trail. They are not encrypted.

Important: Please note that the sample ID field must not contain any personal data.

5.4.8 Loading the shaker

The **Load shaker** screen guides you through the loading of the shaker.

Depending on the selected protocol, loading of the shaker might not be required. In this case, the software will indicate that this step can be skipped.

Depending on the selected protocol, samples and/or other tubes must be loaded on the shaker.

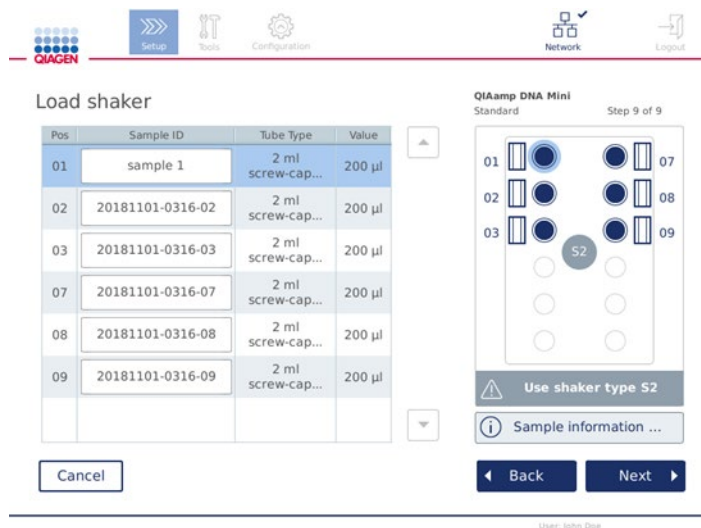

Loading of shaker; lid positions filled with shaker rack plugs

In this step, the software displays the shaker positions, tubes and volume to be loaded in the table and in the schematic on the right. Make sure to load the correct shaker rack type as described on the right side of the screen. The shaker adapter can only be loaded in the correct orientation. Make sure to read all essential and critical information stated under **Sample information** before proceeding to the next step.

1. Ensure that you are using the correct shaker rack type.
2. If required, change the default **Sample IDs** in the respective fields using the on-screen keyboard. You can enter the value manually or scan the sample bar code using a barcode scanner. The sample ID is initially created using the YYYYMMDD-HHMM-no. format.

Note: Sample IDs are part of the run reports and can be part of log files and audit trail. They are not encrypted.

3. Prepare the correct tubes. Ensure that you read all essential and critical information indicated in the **Information** icon (i) marked in red. Information about the labware to use can also be found in the respective kit handbook. If you use sticky label on the tubes, ensure to use a thin label which allows to insert the tube completely into the shaker position.
4. Load the tubes into the correct position of the shaker rack. The shaker rack positions are numbered for easy identification. Touch the table row to highlight the position in the schematic at the right. Be sure to use the same position numbers for shaker and centrifuge rotor buckets for same sample IDs.
5. Depending on the tube type, a shaker rack plug or the tube lid must be placed into the slot next to the tube, as shown on the screen or indicated in the **Information** icon (i). Make sure that the lid/shaker rack plug is securely seated in the slot. Do not place a lid or shaker rack plug next to an empty shaker rack position.

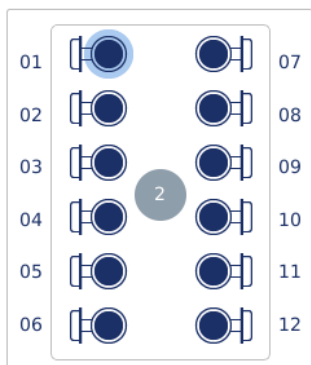

Loading the shaker rack with sample tubes that have attached lids



Lids of sample tubes must be securely placed into the slots at the edge of the shaker rack

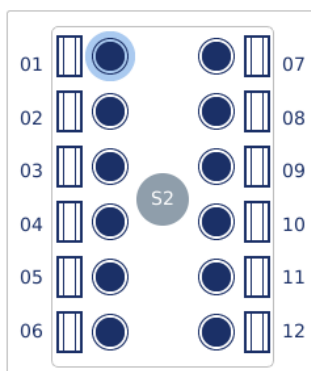

Loading the shaker rack with sample tubes that have screw-cap lids

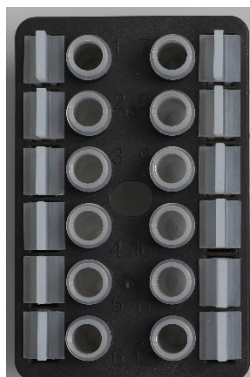

Shaker rack plugs must be placed into the slots at the edge of the shaker rack

- Press **Next** to proceed to starting the run or loading the centrifuge, depending on your selected protocol.

<p>WARNING</p> 	<p>Risk of personal injury and material damage [W5]</p> <p>To prevent plastic crash, load the tubes properly. After a plastic crash, sharp plastic particles could be inside the centrifuge. Be careful when handling items inside the centrifuge.</p>
---	---

Important: Do not use 1.5 ml microcentrifuge tubes on the shaker. These microcentrifuge tubes can cause filter-tips to stick during sample transfer. Using this tube on the shaker can damage the pipetting system and can cause a centrifuge crash.

5.5 Starting a protocol run

A confirmation message will appear when the final step on the last setup screen has been completed.



1. Close the hood to continue.
2. Press **Start** to begin the run. The screen will display the estimated run duration. If required, press **Back** to return to the previous setup screen.

Important: Do not open the instrument hood during a run. In the event the hood is opened during a run, the run will stop. If the tip adapter has picked up a tip, it must be removed manually.

Note: For the very first run, the estimated run duration is not available.



Remaining time to finish run

10:54 min

Run Details ... Stop Run

User: Admin Admin

Run status screen during a protocol run

During the run, you can press the **Run Details** button to display the run steps. To return to the run view, press **Close**.

Step	Progress
Lyse	COMPLETED
Incubate	...
Bind	—
Wash	—
Elute	—

Close

Run details screen

- When the protocol run is completed, the output position and content will be shown on the right side of the screen. For some protocols, further treatment of samples is described on the right side of the screen. Remove the eluates/samples from the instrument directly after the run finished and make sure that you follow the proper procedures for storing and handling the samples.

QIAGEN Setup Tools Configuration Simulator Network Lock Logout

Run Completed
02:59 p.m.

Output 1: DNA
Output 1 position:
Rotor adapter position 3

The run has been completed. The output position number refers to the number of the centrifuge bucket.

Press [Done] to confirm output removal.
Check Run Report for Sample positions and run validity.

Move left Move right Run Details ... Done

Aug 18, 2020, 14:59 Mode: IVD User: Admin Admin

Run completed screen

- Press **Done** to create the report file. The run report is a PDF file and contains the following information:
 - the protocol information (name and the version of the completed application process file)
 - the serial number of the instrument

- the software version
- the sample IDs and their positions
- the time, date, and user at the run start
- the time and date of the run end
- the user that confirmed the end of run
- the kit material number, lot number, and expiration date
- the error and warning descriptions
- the run validity (valid or invalid)
- the run status (completed or aborted)
- the software mode (IVD or Research)
- the run ID
- the elution volume
- the final eluate position

Important: It is recommended to perform regular maintenance as described in section 6.3, Regular maintenance procedure, before starting the next run.

5.6 Stopping a protocol run

In case of emergency, a run can be stopped by pressing the **Stop Run** button on the run status screen (see section 5.5, Starting a protocol run). To confirm the run stopped, click **Yes** in the **Stop Run** dialog.

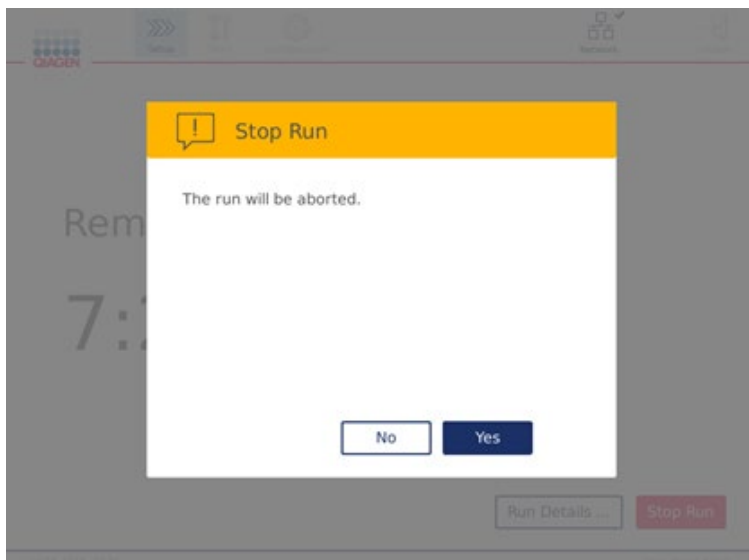

Stop run screen

If a run is stopped, perform the daily maintenance as described in section 6.4, Daily maintenance procedure, and ensure that no plastic parts are present in the centrifuge before starting the next run. Additionally, it is recommended to reboot the system before starting the next run.

Note: If a protocol run is stopped, the run cannot be restarted. Under the **Run Details**, you will find the step at which the protocol stopped.

5.7 Saving run reports to the USB flash drive

Run reports are saved on the instrument after each run is confirmed by clicking the **Done** button. The number of run reports on the instrument is limited. If the remaining space on the internal storage reaches 10% of the total capacity, you are prompted to perform a backup of report files.

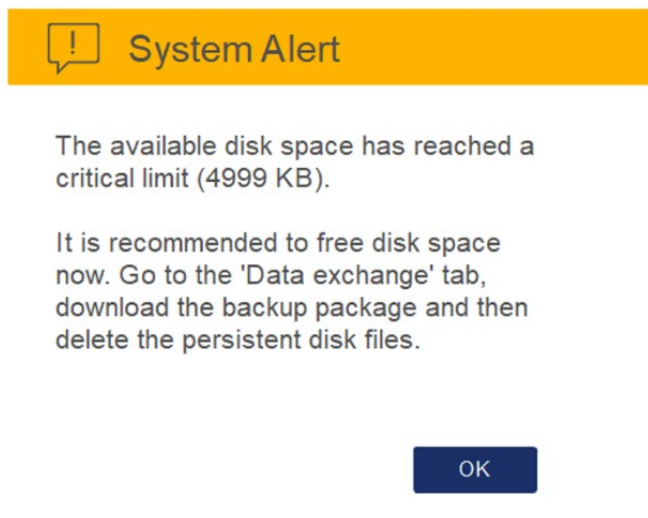

Warning on critical remaining disk space

On a regular basis, you can also check the free disk space by clicking on the **Configuration** icon located on the right side of the **System** tab screen.

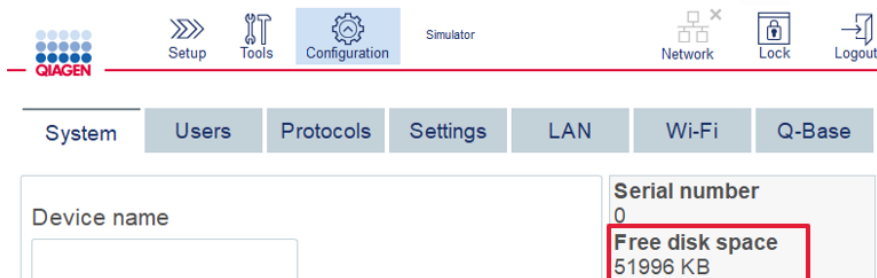

Free disk space information

To transfer run reports to the USB flash drive, proceed as follows:

1. Press the **Tools** icon (🔧) on the menu bar.
2. Press the **Data exchange** tab. The number of available run reports is shown on the screen.

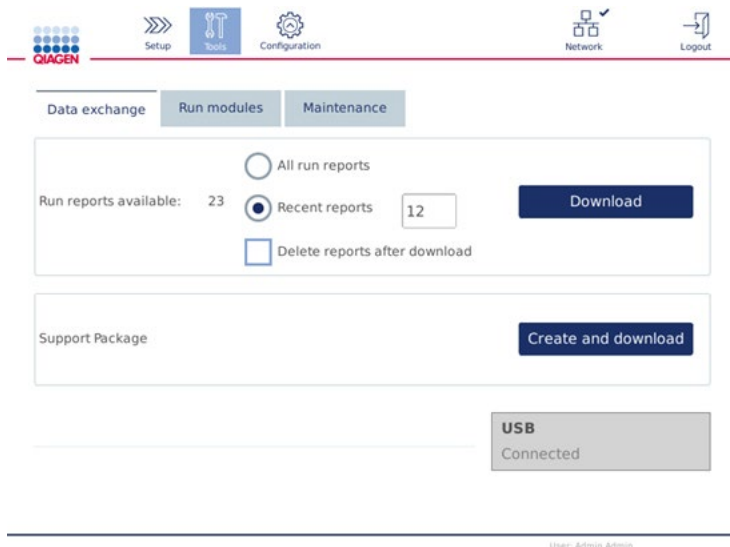

Data exchange screen

3. If not yet connected, connect the USB flash drive which is delivered with the instrument, to one of the USB ports at the left of the touchscreen.
Important: Only use USB flash drive which is delivered with the instrument and ensure that the USB flash drive has enough remaining space prior to initiate the procedure of saving the run reports.
4. To save all available run reports to the USB flash drive, select **All run reports**. To save only the recent reports, select **Recent reports**. To enter the number of reports to be saved, touch in the **Recent reports** field.
5. If you would like to delete reports from the instrument after download, press **Delete reports after download**.
Important: The deleted reports cannot be restored from the instrument. Ensure that all files have been correctly and completely transferred on the USB, then save the files from the USB stick to a safe place.
6. Press **Download** to save the reports to the USB flash drive. A confirmation message that run reports are successfully saved to the USB flash drive will appear. The USB flash drive can be removed from the instrument.
Important: Do not remove the USB flash drive while the files are downloading. Wait until the download is completed

- On the data exchange screen, you can also create a download package, which contains additional information like the logfiles. You can also check the remaining disk space.

Important: If you use **Delete Files**, ensure to store the files from the USB stick at a safe place.

5.8 Low space on flash memory

If the flash memory disk is full, you cannot start a run. The system will show an alert and guide you to the download screen. After downloading the files, confirm if they are successfully saved to the USB stick, then store the files properly. When the backup is confirmed, you can delete the files on the QIAcube Connect MDx USB flash drive.

System alert - Disk space is full

There is not enough disk space available to continue instrument operation. Free disk space now!

Step 1: Backup disk files by pressing 'Download files'.

Step 1: Download data to USB stick	<input type="button" value="Download files"/>
Step 2: Check downloaded files on USB stick	<input type="button" value="Check done"/>
Step 3: Delete files on disk to free up disk space	<input type="button" value="Delete files"/>

USB
Connected

Full disk space system alert

5.9 Independent heater/shaker operation

The heater/shaker can be operated individually if the QIAcube Connect MDx is not running a protocol. The heating and shaking functions are not interlinked and can be used independently or in combination.

Do not attempt to move the QIAcube Connect MDx during operation.

WARNING 	Hot surface The shaker can reach temperatures of up to 70°C (158°F). Avoid touching it when it is hot. Carefully remove the samples after a run.	[W21]
---	--	--------------

1. Press the **Tools** icon () on the menu bar.
2. Press the **Run Modules** tab.
3. Press the **Heater Shaker** tab.

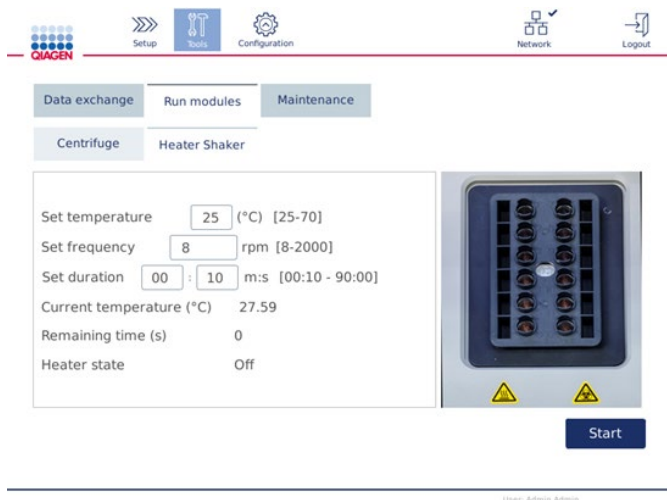

Heater Shaker operation screen

4. Press the appropriate field to select the **Frequency**, **Temperature** and **Duration** using the on-screen keyboard.
5. Load the shaker rack tubes containing samples.
6. Close the hood to start run.

The remaining time and current temperature and status of the heater are displayed on the screen. Wait until the operation is completed.

To stop the run progress, press **Stop**.

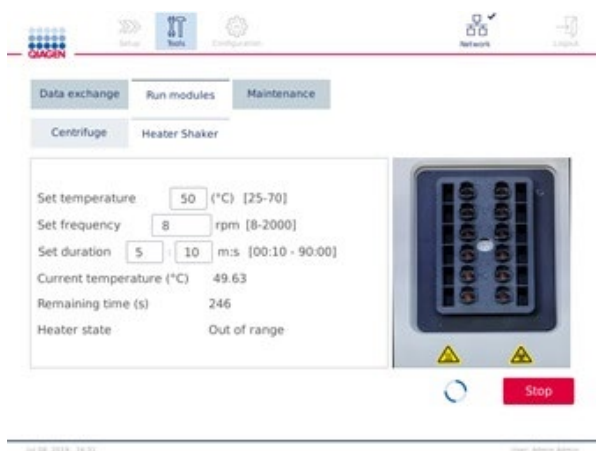





Heater Shaker operation screen

5.10 Independent centrifuge operation

The centrifuge can be operated individually if the QIAcube Connect MDx is not running a protocol.

Do not attempt to move the QIAcube Connect MDx during operation.

<p>CAUTION</p> 	<p>Damage to the instrument [C7]</p> <p>The QIAcube Connect MDx must not be used if the centrifuge lid is broken, or if the lid lock is damaged.</p> <p>Make sure that no loose material is inside the centrifuge during operation.</p> <p>Make sure that the rotor is installed correctly and that all buckets are properly mounted, regardless of the number of samples to be processed. Load the rotor only as instructed by the software.</p> <p>Only use rotors, buckets, and consumables designed for use with the QIAcube Connect MDx. Damage caused by use of other consumables will void your warranty.</p> <p>We recommend replacing the centrifuge rotor and buckets after 20,000 cycles, which is equivalent to 9 years of usage with two runs per day for 220 days each year. For more information contact QIAGEN Technical Services.</p>
<p>WARNING</p> 	<p>Moving parts [W19]</p> <p>In case of breakdown caused by power failure, remove the power cord and wait 10 minutes before attempting to manually open the centrifuge lid.</p>
<p>CAUTION</p> 	<p>Damage to the instrument [C8]</p> <p>After a power failure, do not move the z-module (robotic arm) manually in front of the instrument. Damage may occur if the QIAcube Connect MDx hood is closed and collides with the z-module.</p>
<p>CAUTION</p> 	<p>Risk of overheating [C9]</p> <p>To ensure proper ventilation, maintain a minimum clearance of 10 cm at the sides and rear of the QIAcube Connect MDx.</p> <p>Slits and openings that ensure the ventilation of the QIAcube Connect MDx must not be covered.</p>

WARNING 	Risk of personal injury and material damage [W20] Raise the centrifuge lid carefully. The lid is heavy and may cause injury if it falls.
---	---

1. Press the **Tools** icon () on the menu bar.
2. Press the **Run Modules** tab.
3. Press the **Centrifuge** tab.

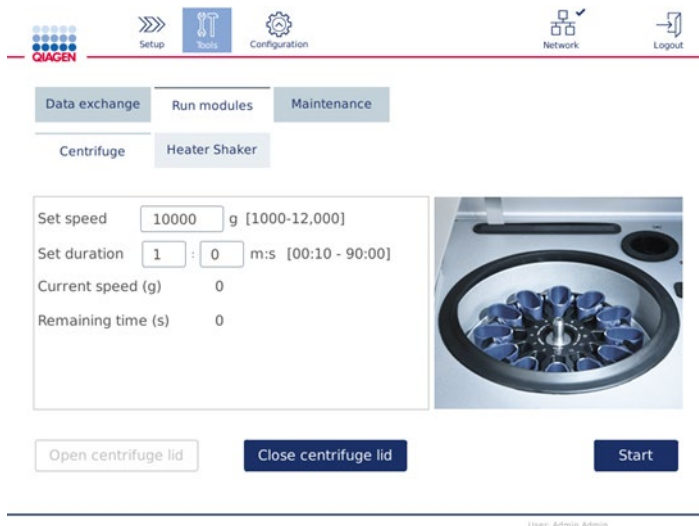

Centrifuge operation screen

4. Press the appropriate field to select the **Speed** and **Duration** using the on-screen keyboard.
5. If the centrifuge lid is not open, press **Open Centrifuge Lid**.
6. If required, load opened 1.5 ml microcentrifuge elution tubes and/or QIAGEN spin columns into the rotor adapters and place the lids into the appropriate slots in the rotor adapter.
7. Ensure that the tubes and spin columns are pushed firmly into the appropriate rotor adapter position.
8. Make sure that the lids are pushed all the way down to the bottom of the slots on the sides of the rotor adapter. If required, cut off the lid.
9. Place the rotor adapters into the centrifuge.

Important: If fewer than 12 samples are to be processed, ensure that you load the correct centrifuge positions as described in the **Loading scheme** table below. One or 11 samples cannot be loaded.
10. Close the hood and press **Start** to start centrifugation.

Note: The Close centrifuge lid button is not needed to start a centrifuge run, as the lid will close automatically. It is only required in case you need to prepare the QIAcube Connect MDx for shipment.

Loading scheme:

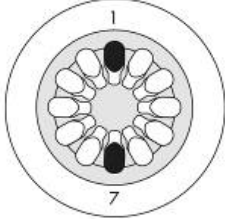
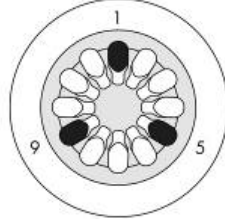
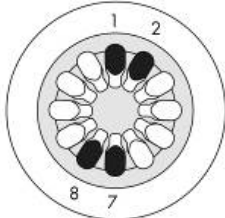
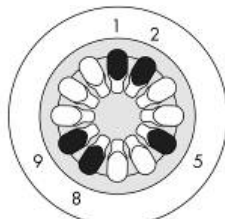
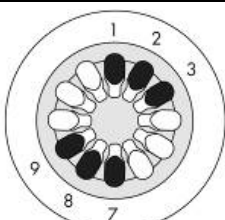
No. of samples	Centrifuge loading scheme
2	
3	
4	
5	
6	

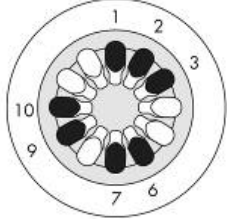
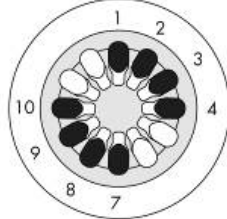
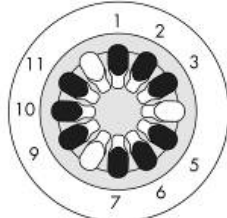
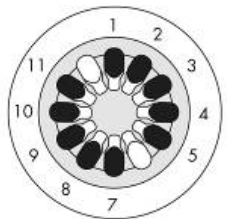
No. of samples	Centrifuge loading scheme
7	
8	
9	
10	
12	Load all positions

Centrifuge loading scheme

5.11 Managing protocols

Commonly used QIAGEN standard protocols are installed on the QIAcube Connect MDx upon delivery. The range of QIAGEN standard protocols is continuously expanding, and these protocols are downloadable at no cost. See the **Product Resources** tab at <https://www.qiagen.com/products/qiacube-connect-mdx>. QIAGEN's Application Lab Specialists can also customize these protocols or develop new protocols depending on your needs. Customized protocols can only be used in the Research mode of the software and are not validated and cannot be used for diagnostic purposes. Protocols can also be removed from the QIAcube Connect MDx. Protocols can only be managed by users assigned the Administrator role.

Important: User can only delete all protocols at once and cannot choose a single protocols for removal.

5.11.1 Installing new protocols

This process is used to install new protocols and translated protocols from new language packages, see **section 4.4.1, System configurations**.

1. On a computer running Microsoft® Windows®, download the new protocols from this URL:
See the **Product Resources** tab at <https://www.qiagen.com/products/qiacube-connect-mdx>.
Use the USB flash drive that was shipped with the QIAcube Connect MDx to transfer the protocol files to the instrument.
Create a new folder on the USB flash drive with the name **Protocol_Upload** and copy the new protocol zip file(s) to this directory. Do not unzip the files. Make sure to use the correct directory, otherwise, the QIAcube Connect MDx will not find the protocols. If you downloaded a language package, the correct folder structure will be readily available.
Note: Do not rename or modify the protocol files. Otherwise, they cannot be used.
2. Connect the USB flash drive to the QIAcube Connect MDx using one of the USB ports at the left of the touchscreen.

3. Select the **Configuration** icon (⚙️).
4. Press the **Protocols** tab.

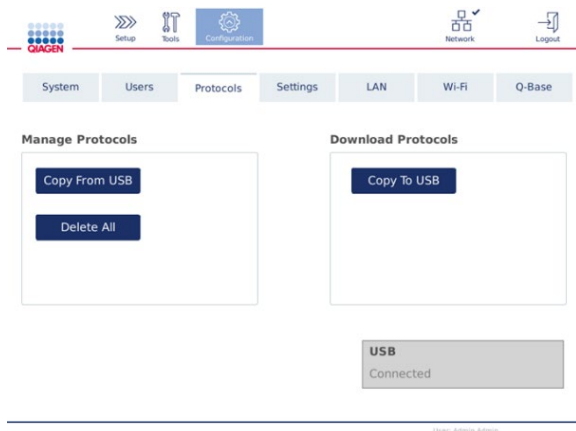

Protocols configuration screen

5. Press **Copy from USB**.
6. A message is displayed indicating how many protocols are found on the USB flash drive. Press **Yes** to start uploading.

All protocol zip file(s) in the **Protocol_Upload** folder will be installed.

Note: Already installed protocols will not be overwritten. If you attempt to re-install an existing protocol, a message will appear indicating that not all protocols could be copied.

Note: If a new protocol version is uploaded, the instrument will automatically use the newest version and display the protocol version in the run setup screen.

7. Wait until the transfer is complete. A message is displayed when the transfer is complete.
8. Remove the USB flash drive and power OFF the QIAcube Connect MDx.
9. Wait a few seconds and then power ON the QIAcube Connect MDx. To use the new protocols, log in again.

To transfer all installed protocols to the USB flash drive, press **Copy to USB**.

5.11.2 Deleting all protocols

Important: Before deleting, you should back up the protocols on the USB flash drive provided with the instrument. See section 5.11.3, Saving protocols.

1. Select the **Configuration** icon (⚙️).
2. Press the **Protocols** tab.

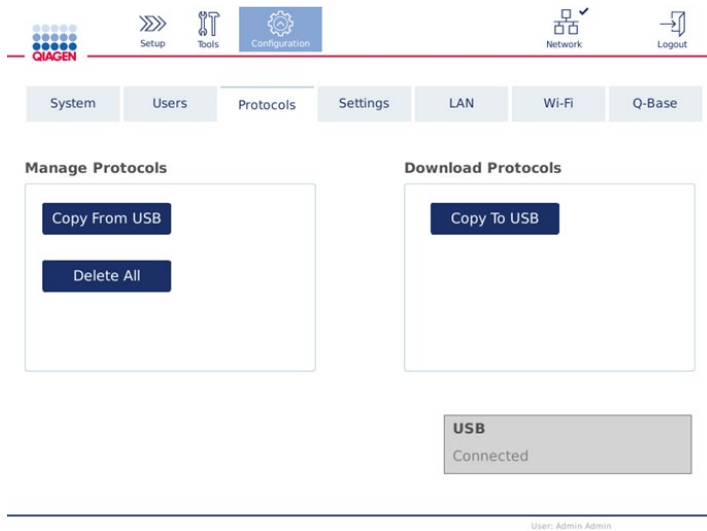

Protocols configuration screen

3. To delete all protocols installed on the instrument, press **Delete All**. It is not possible to delete a single protocol from the QIAcube Connect MDx.

Note: After deleting all protocols, a selective upload of protocols will reduce the options during run setup. This is done by copying only the desired protocols from the backup you created to the **Protocol_Upload** folder on the USB stick.

5.11.3 Saving protocols

Protocols can be downloaded from the instrument to USB flash drive to transfer them to another instrument or to save them before a software update. Use the USB flash drive provided by QIAGEN.

1. Connect the USB flash drive that was shipped together with the instrument to the QIAcube Connect MDx using one of the USB ports at the left of the touchscreen.
2. Select the **Configuration** icon (⚙️).
3. Press the **Protocols** tab.
4. From the **Download Protocols** section, press **Copy To USB**.

Important: Transferring of DSP protocols to a life science instrument is not allowed. This will result to loss of the IVD status of the workflow.

5.12 Updating software

If an updated software version is available for download, it can be accessed at <https://www.qiagen.com/products/qiacube-connect-mdx>, see the **Product Resources** tab. The download creates a ZIP file.

The software can only be updated by users assigned the role Administrator. It is recommended to download all run reports before updating the software and to create a support package, because run reports and support packages will be lost during software update (see section 5.7, Saving run reports to the USB flash drive and section 7.2, Creating a support package).

Note: A new software version might contain new version of the protocols.

1. On the menu bar, press the **Configuration** icon (⚙️).
2. Press the **System** tab.
3. The currently installed software version is shown at the right.

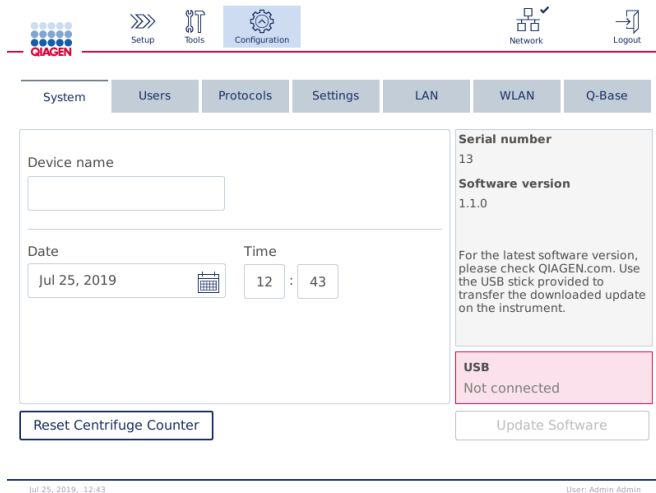

System configuration screen

4. On a computer running Microsoft Windows, download and transfer the software ZIP file to the main folder of the USB flash drive provided with the QIAcube Connect MDx and extract the ZIP file there.

Note: After extraction, make sure that all files from the ZIP file are extracted to the main folder of the USB flash drive.

The update will not work if one of the files is missing or has been renamed. Make sure that only the files for one software version are in the main folder of the USB flash drive.

5. Connect the USB flash drive to the instrument using one of the USB ports at the left of the touchscreen.

Important: Make sure that all run reports and support packages have been backed up before proceeding to the next step. See section 5.7, Saving run reports to the USB flash drive and section 7.2, Creating a support package.

6. Press **Update Software** to start the software update. Follow the instructions on the screen.

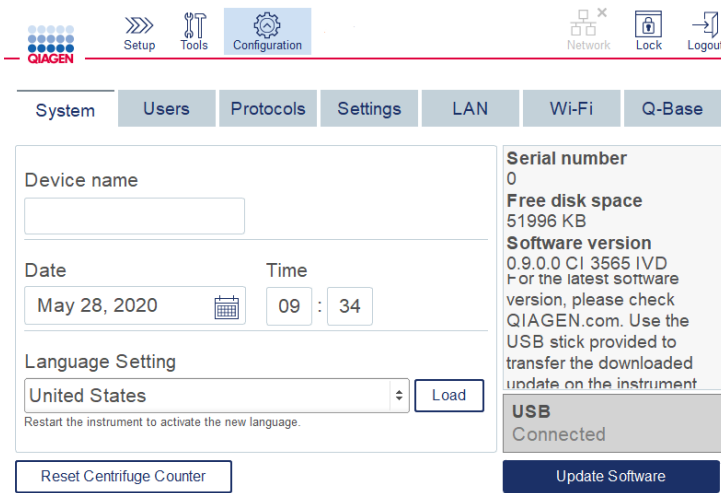

System configuration screen

7. The software update tool is displayed. Press **Start update** to start the software update.

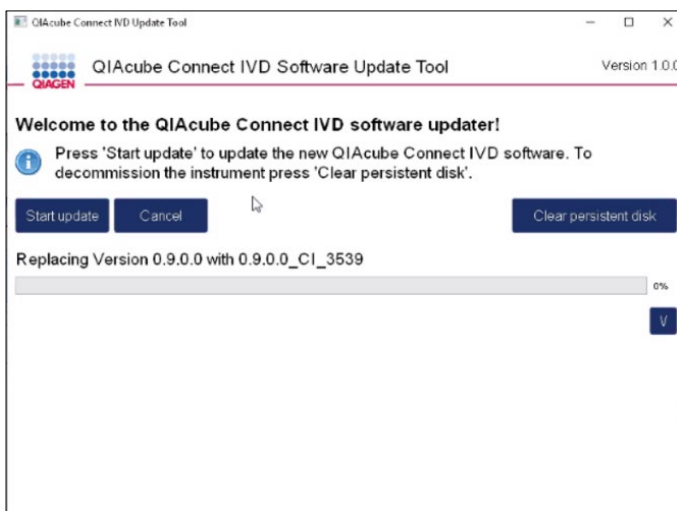

Software update tool screen

Press **Cancel** if you do not want to update the software. In this case, the instrument will initialize without updating the software.

8. Wait until the update has completed.
9. Press the arrow button to open the **Details** screen.

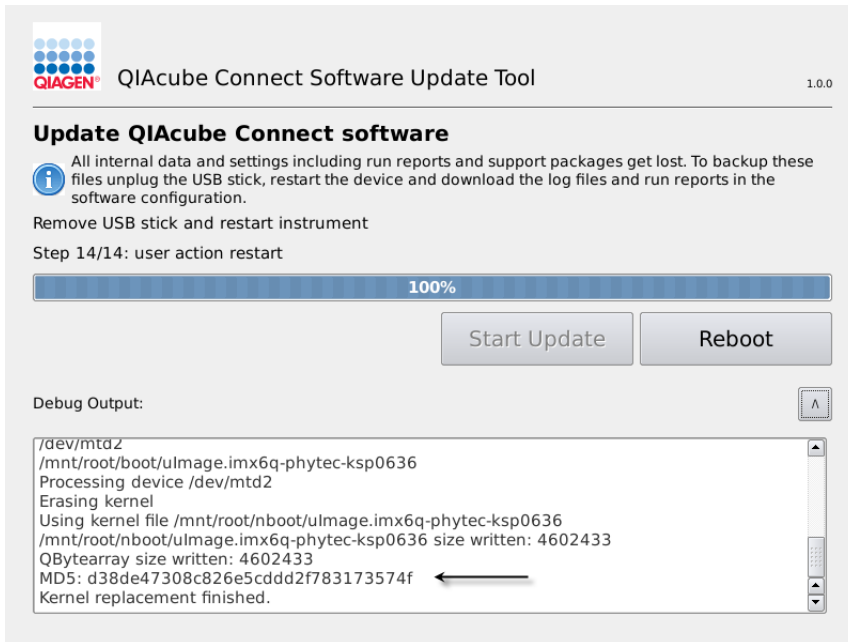

Software update tool with update details to see the MD5 checksum

10. Compare the MD5 checksum on the screen with the checksum provided on the software download page. If the checksums are not identical, contact QIAGEN Technical Services.
11. Press **Reboot** to continue. The instrument will initialize with the updated software.
12. When instructed by the screen, remove the USB flash drive from the USB port.
13. Use a computer running Microsoft Windows to delete the previously downloaded software files from the USB flash drive.

5.13 User Management

The QIAcube Connect MDx is provided with a **User Management** feature. This feature enables you to set up multiple users with two different roles: administrator and operator. For each operator, the software mode (IVD or Research) to be used can be set up. Access to both software modes can be selected for an operator, or a restricted access to only one software mode. When you use the QIAcube Connect MDx for the first time, a default user named Admin is already pre-installed and configured with both roles assigned. The user management feature is only available for users assigned the Administrator role.

5.13.1 Setting up a new user

1. Press the **Configuration** icon (⚙️) on the menu bar.
2. Press the **Users** tab.

The configured users are shown in the table. Each row contains the data for one user.



The screenshot shows the configuration menu with 'Configuration' selected. Below it, the 'Users' tab is active. A table displays the following user:

User Id	First Name	Last Name	Role(s)	Edit
Admin	Admin	Admin	Administrator, Operator	

Below the table, there is a checkbox labeled 'Show only activated user profiles' which is checked, and a 'New ...' button.

List of configured users in the user management

Note: With the administrator role, it is required to create at least one other user.

3. Press **New** to add a new user.
4. Enter the respective data for the new user. Keep the **Activate User** box checked.

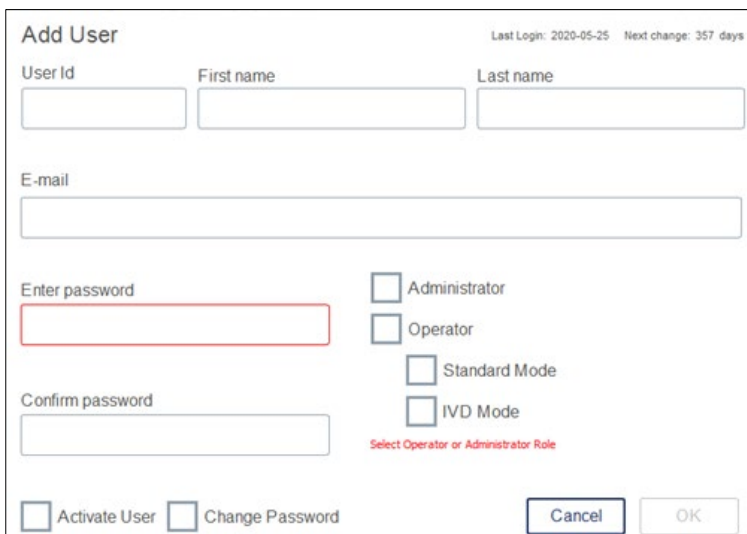

The 'Add User' form includes the following fields and options:

- User Id:
- First name:
- Last name:
- E-mail:
- Enter password:
- Confirm password:
- Role selection:
 - Administrator
 - Operator
 - Standard Mode
 - IVD Mode

Select Operator or Administrator Role
- Activate User:
- Change Password:
- Buttons: Cancel, OK

Add User screen

The **User ID**, **First name** and **Last name** fields are mandatory. These fields may contain up to 30 letters and numerical characters. The user ID must be unique for each user profile. It must contain at least one letter and cannot contain blank spaces. The user ID is used for logging in and is printed on run reports. The first and last name are displayed on the touchscreen for the currently logged in user.

The **Password** field is mandatory and must contain 8–40 letters or numerical characters. Enter the same password into the **Confirm password** field.

Select the user role: **Administrator** and/or **Operator**. The operator may only use the instrument, while the administrator is also allowed to configure the system. One user can have both roles assigned at the same time. The default user **Admin** has both user roles assigned.

Important: A newly created user with administrator rights can only configure the system and cannot start a run. If this is required both roles have to be chosen.

The screenshot shows the 'Add User' screen with the following fields and options:

- User Id**, **First name**, and **Last name** text input fields.
- E-mail** text input field.
- Enter password** text input field.
- Confirm password** text input field.
- Role selection checkboxes: Administrator, Operator, Research Mode, and IVD Mode. The Administrator and Operator checkboxes are highlighted with a red box.
- Bottom options: Activate User, Change Password, , and .

Selection of user role in Add User screen

The **E-mail** address field is optional. The system does not confirm whether the e-mail address entered is valid.

5. Press **OK** to save the new user.

5.13.2 Changing data for an existing user

1. Press the **Configuration** icon (⚙️) on the menu bar.
2. Press the **Users** tab.

The configured users are shown in the table. Each row contains the data for one user.

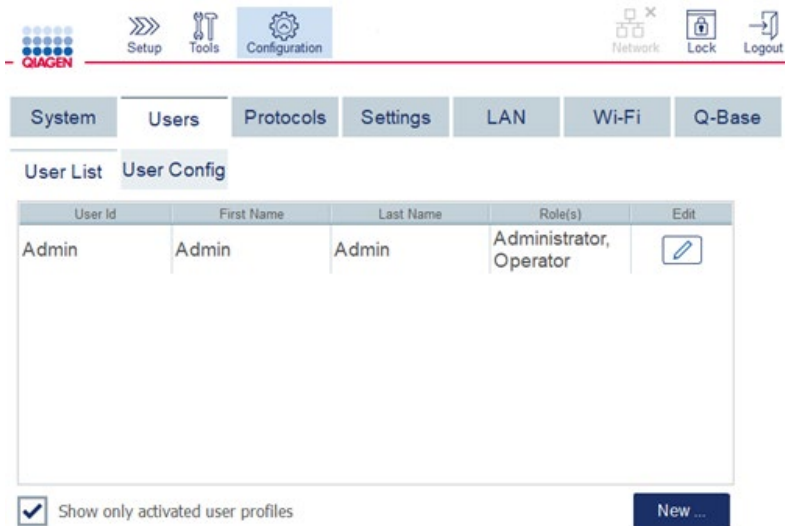

List of configured users in the user management

3. In the user profile row, press the **Edit** () icon.
4. A screen will appear showing the current information of the user. Edit the information as necessary.

Edit User Last Login: 2020-06-04 Next change: 49 days

Anonymous user ID: First name: Last name:

E-mail:

Enter password: Administrator
 Operator

Confirm password: Research Mode
 IVD Mode

Activate User Change Password

Edit User screen

The user's password will not be displayed. If you touch the password field, the existing password will be cleared, and a new password must be entered and confirmed.

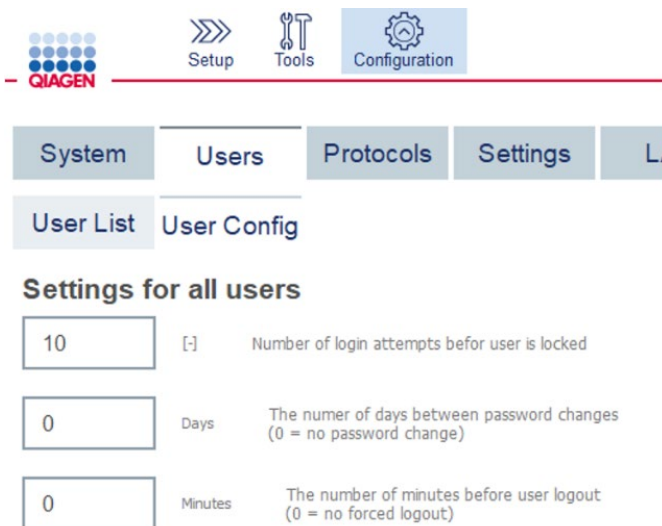

5. To confirm the changes, press **OK**. To close the dialog and discard the changes, press **Cancel**.
6. The administrator can also change the user configuration on the **Users** tab. The administrator can set a number of login attempts, the number of days between password changes, and the number of minutes before automatic logout.

Note: The input range to define the number of login attempts is 0 to 10. However, it is strongly recommended to avoid setting up the number of login attempts at 0. This might create a risk of the system being locked in case of an error during the password entry and cannot be unlocked by any users. This issue would require the intervention of a service engineer. Number of login attempts set up at 2 and higher would minimize this risk.



Users Configuration screen

5.13.3 Deleting or temporarily deactivating a user

1. To delete a user, press the **Delete** icon () in the user profile row. It is not possible to delete the currently logged-in administrator.
2. To temporarily deactivate a user, press the **Edit** icon () in the user profile row. Uncheck the **Activate User** box. It is not possible to deactivate the currently logged-in administrator.
3. To reactivate a user profile, press the **Edit** icon () in the user profile row. Check the **Activate user** box.

Note: If a user tries to login with the wrong password, the user profile will be automatically deactivated after the set number of failed login attempts.

Deactivated users can be displayed in the users list by unchecking the box **Show only activated user profiles**. If the box is unchecked, all user profiles will be listed.

If the pre-installed administrator user **Admin** has more than the set number of failed login attempts, the password can be reset. To do so, press **Reset admin user**. Then log in again with the default user ID **Admin** and password **Admin**.

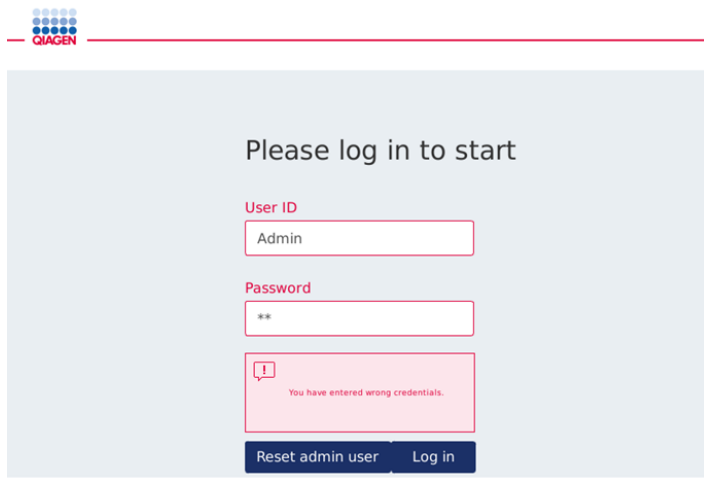

Login screen after failed Admin login

5.13.4 Changing password

User with Administrator role is allowed to change the password for every user by editing the user profile. Refer to section 5.13.2, Changing data for an existing user, for more details. Passwords are never displayed in this process, so the administrator cannot view password.

User with Operator role can change its own password. Follow the instructions below:

1. Press the **Configuration** icon () on the menu bar.
2. For users with the role **Operator**, the **Password** tab is automatically active

The screenshot shows the QIAGEN configuration interface. At the top, there is a navigation bar with icons for Setup, Tools, Configuration (highlighted), Network, and Logout. Below this is a secondary menu with tabs for System, Password (selected), Protocols, Settings, LAN, Wi-Fi, and Q-Base. The main content area contains three text input fields labeled "Old password", "New password", and "Confirm new password". At the bottom of the form are two buttons: "OK" and "Cancel". A small text label "User: John Doe" is visible at the bottom right of the interface.

Change password screen

3. Enter the old password into the **Old password** field. Touch the field to open the on-screen keyboard.
4. Enter a new password into the **New password** field, and re-enter the new password in the **Confirm new password** field.
Note: The new password must be different from the last three used passwords.
5. Press **OK** to save the new password. Press **Cancel** to discard any changes and to keep the old password.
6. To return to the setup screen, press the **Setup** icon ()

6 Cleaning and Maintenance

WARNING/ CAUTION 	Risk of personal injury and material damage [W22] Only perform maintenance that is specifically described in this user manual.
--	--

Important: The following maintenance procedures must be carried out to ensure reliable operation of the QIAcube Connect MDx:

- Regular maintenance: after **each** protocol run
- Daily maintenance: after the last protocol run of the day
- Monthly maintenance: every month
- Periodic maintenance: when necessary; at least every 6 months

Optionally, these procedures may be performed to check and ensure the reliability of operation of the QIAcube Connect MDx:

- UV Run: reduces pathogen and nucleic acid contamination
- Tightness Test: ensures the tightness of the tip adapter (e.g., after O-Ring change)

The software provides step-by-step guidance under **Tools/Maintenance** for the maintenance procedures listed above, except for the regular maintenance.

Following these procedures ensures that the QIAcube Connect MDx is free from dust and liquid spills.

Select the cleaning agent according to the objective of the cleaning procedure, the sample material used and the downstream assay.

WARNING 	Risk of fire or explosion [W6] When using ethanol or ethanol-based liquids on the QIAcube Connect MDx, handle such liquids carefully and in accordance with the required safety regulations. If liquid has been spilled, wipe it off and leave the QIAcube Connect MDx hood open to allow flammable vapors to disperse.
---	---

Before using any cleaning or decontamination methods except those recommended by the manufacturer, users should check with the manufacturer that the proposed method will not damage the equipment.

6.1 Cleaning agents

The following disinfectants and detergents are recommended for cleaning the QIAcube Connect MDx.

Note: If you want to use disinfectants different from those recommended, ensure that their compositions are like those described below.

General cleaning of the QIAcube Connect MDx:

- Mild Detergents (e.g., Mikrozyd® AF sensitive)
- 70% ethanol (for cleaning the worktable only; not for cleaning the QIAcube Connect MDx hood)

6.2 Disinfection

Ethanol-based disinfectants can be used for disinfection of surfaces, such as the worktable or inside the centrifuge: e.g., 25 g ethanol and 35 g 1-propanol per 100 g liquid or Mikrozyd Liquid (Schülke & Mayr GmbH, e.g. cat. no. 109203 or 109160).

Disinfectants based on glyoxal and quaternary ammonium salt can be used for submerging worktable items, the centrifuge rotor, and the waste drawer: e.g., 10 g glyoxal, 12 g lauryldimethylbenzylammonium chloride, 12 g myristyldimethylbenzylammonium chloride, and 5–15% nonionic detergent per 100 g liquid, Lysetol® AF (Gigasept® Instru AF in Europe, cat. no. 107410, or DECON-QUAT® 100, Veltek Associates, Inc., in the USA, cat. no. DQ100-06-167-01).

General instructions

- Do not use spray bottles to spray cleaning or disinfectant liquids onto surfaces of the QIAcube Connect MDx workstation. Spray bottles should be used only for items that have been removed from the workstation.
- If solvents or saline, acidic, or alkaline solutions are spilt on the QIAcube Connect MDx or if QIAGEN buffers splash the instrument hood, wipe the spilt liquid away immediately.
- Follow manufacturer's safety instruction for handling cleaning agents.
- Follow manufacturer's instruction for soaking time and concentration of the cleaning agents. Immersing for longer than the recommended soak time can harm the instrument.
- Do not use alcohol or alcohol-based disinfectants to clean the QIAcube Connect MDx hood. Exposing the QIAcube Connect MDx hood to alcohol or alcohol-based disinfectants will cause surface cracking. Clean the QIAcube Connect MDx hood with distilled water only or a mild detergent.

- Do not submerge buffer bottles in 70% alcohol. The blue ring is not ethanol resistant.
- Take care that no liquid runs down the touchscreen. Liquid may be drawn through the dust protection sealing by capillary forces and cause malfunction of the display. To clean the touchscreen, moisten a soft lint-free cloth with water, ethanol, or a mild detergent and carefully wipe the display. Wipe dry with a paper towel.

Removal of RNase contamination

RNaseZap® RNase Decontamination Solution (Ambion, Inc., cat. no AM9780) can be used for cleaning surfaces and submerging worktable items, centrifuge rotor, and waste drawer. RNaseZap can also be used to perform decontamination by spraying the respective worktable items.

Removal of nucleic acid contamination

DNA-ExitusPlus™ (AppliChem, cat. no. A7089,0100) can be used for cleaning surfaces and submerge worktable items, centrifuge rotor, and waste drawer. DNA-ExitusPlus can also be used to perform decontamination by spraying the respective worktable items (use the nucleic acid decontamination agent according to the manufacturer’s instructions). Although the supplier of DNA-ExitusPlus only recommends to clean items when there are unwanted dried residual traces of the reagent, we recommend to wipe items with a wet lint-free cloth and sterile water at any rate. This is especially important for the rotor and swing-out buckets so that the buckets do not get stuck during centrifugation and positioning.

CAUTION 	Damage to the instrument Do not use bleach, solvents, or reagents containing acids, alkalis, or abrasives to clean QIAcube Connect MDx.	[C10]
---	---	--------------

CAUTION 	Damage to the instrument Do not use spray bottles containing alcohol or disinfectant to clean surfaces of the QIAcube Connect MDx. Spray bottles should be used only to clean items that have been removed from the worktables.	[C11]
---	---	--------------

WARNING 	Risk of fire Do not allow cleaning fluid or decontamination agents to come into contact with the electrical parts of the QIAcube Connect MDx.	[W24]
---	---	--------------

WARNING 	<p>Risk of electric shock [W10]</p> <p>Do not open any panels on the QIAcube Connect MDx.</p> <p>Risk of personal injury and material damage</p> <p>Only perform maintenance that is specifically described in this user manual.</p>
---	---

WARNING 	<p>Hazardous chemicals and infectious agents [W16]</p> <p>The waste may contain toxic material and must be disposed of properly. Refer to your local safety regulations for proper disposal procedures.</p>
---	---

WARNING 	<p>Risk of personal injury and material damage [W1]</p> <p>Improper use of the QIAcube Connect MDx may cause personal injuries or damage to the instrument. The QIAcube Connect MDx must only be operated by qualified personnel who have been appropriately trained.</p> <p>Servicing of the QIAcube Connect MDx must only be performed by a QIAGEN Field Service specialist.</p>
---	--

WARNING 	<p>Risk of explosion [W23]</p> <p>When cleaning the QIAcube Connect MDx with alcohol-based disinfectant, leave the QIAcube Connect MDx hood open to allow flammable vapors to disperse.</p> <p>Only clean the QIAcube Connect MDx when worktable components have cooled down.</p>
---	---

WARNING 	<p>Risk of fire or explosion [W6]</p> <p>When using ethanol or ethanol-based liquids on the QIAcube Connect MDx, handle such liquids carefully and in accordance with the required safety regulations. If liquid has been spilled, wipe it off and leave the QIAcube Connect MDx hood open to allow flammable vapors to disperse.</p>
---	---

WARNING 	<p>Toxic fumes [W14]</p> <p>Do not use bleach to clean or disinfect the QIAcube Connect MDx. Bleach in contact with salts from the buffers can produce toxic fumes.</p>
---	---

WARNING 	<p>Toxic fumes [W15]</p> <p>Do not use bleach to disinfect used labware. Bleach in contact with salts from the buffers used can produce toxic fumes.</p>
---	--

6.3 Regular maintenance

After running a protocol, perform the regular maintenance procedure described below.

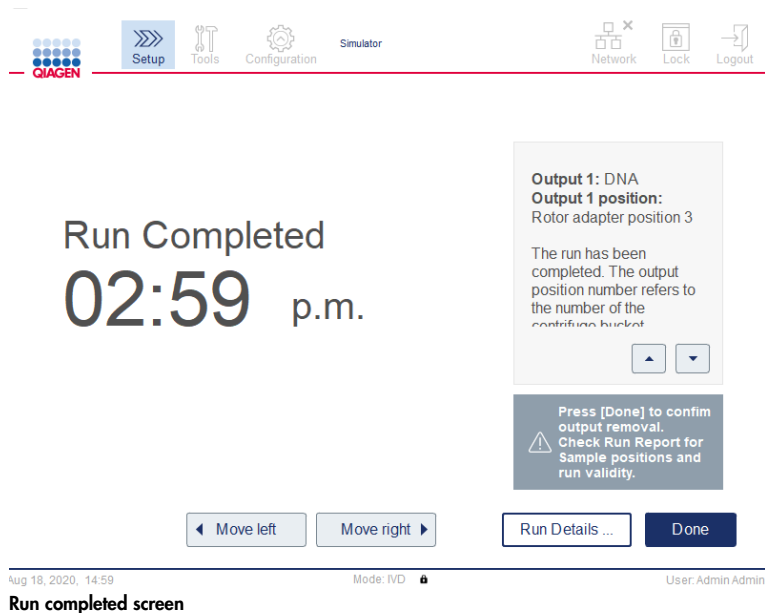

1. Open the waste drawer and empty tips and columns (if necessary) into a suitable laboratory waste container.
2. Remove used disposable labware and unwanted samples and reagents from the worktable. Discard them according to your local safety regulations.

Note: If the robotic arm prevents you from reaching a position, do not move the robotic arm manually. Instead, proceed as follows:

Press **Move left** or **Move right** on the Run Completed screen, as needed. The robotic arm will start to move. The hood can remain open during this movement.

Ensure that you stand clear of the instrument while the robotic arm is moving. Wait until the robotic arm has completed its movements.

3. Replace the lids of the reagent bottles and close tightly. Store the bottles according to the instructions in the relevant kit handbook.

You can now run another protocol or switch off the QIAcube Connect MDx.

6.4 Daily maintenance

After running the last protocol of the day, perform the daily maintenance procedure. The software guides you through each step to be performed:

1. To start the daily maintenance, press the **Tools** icon () on the menu bar.
2. Then press the **Maintenance** tab and select the **Daily** subtab. The screen shows the **Last Executed** and the **Next Due** daily maintenance dates.

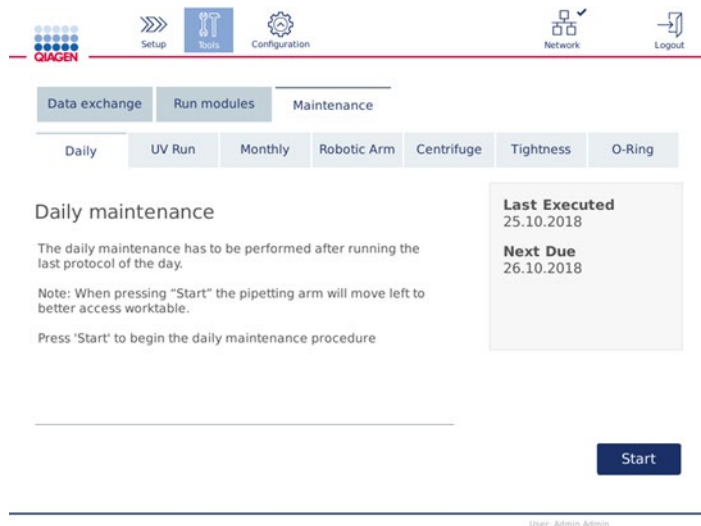

Daily maintenance screen

3. Press **Start**. Follow the instructions on the screen. Details are provided in the next steps below.
The robotic arm will automatically move slowly to the left – even if the instrument hood is open – to provide access to the loading positions. Always stand clear of the instrument while the robotic arm is moving. Wait until the robotic arm has completed its movements before you start to unload.
4. Remove used disposable labware, adapters and unwanted samples and reagents from the worktable. If required, discard them according to your local safety regulations.
5. Close the buffer bottles tightly and store according to the instructions in the relevant kit handbook. We recommend to reuse the buffer bottles only until the kit is used up. As soon as a new QIAGEN kit is opened, new buffer bottles should be used.
6. Press **Done** to confirm that the steps have been completed.
7. Empty the waste drawer and check that the inlay is clean. If necessary, clean the inlay of the waste drawer with alcohol-based disinfection wipes, or by soaking using one of the cleaning agents listed above, and then rinse with distilled water.
8. Wipe and clean the worktable with alcohol-based disinfection wipes. Incubate as appropriate, wipe thoroughly with distilled water and wipe dry with lint-free paper towels.
Note: Do not use alcohol or alcohol-based disinfectants to clean the hood.
9. Press **Done** only when the steps listed above have been successfully completed. The date of the last performed daily maintenance is updated automatically.

The robotic arm will automatically move back to its original position (above tip rack position 3).

6.5 Monthly maintenance

Perform the daily maintenance procedure (refer to section 6.4, Daily maintenance) before you perform the monthly maintenance procedure. Select the appropriate cleaning agent according to the sample material and downstream assay (refer to section 6.1, Cleaning agents).

1. To start the monthly maintenance, press **the Tools** icon (🔧) on the menu bar.
2. Then press the **Maintenance** tab and select the **Monthly** subtab. The screen shows the **Last Executed** and the **Next Due** monthly maintenance dates.

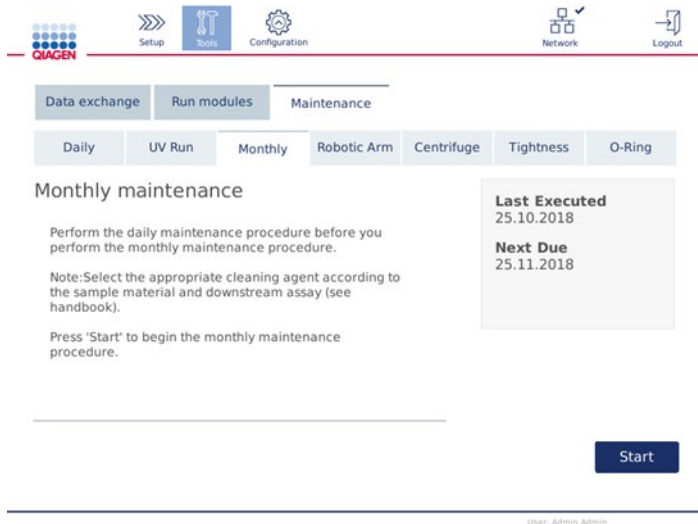

Monthly maintenance screen

3. Close the hood.
4. Press **Start**. Follow the instructions on the screen. Details are provided in the next steps below. The robotic arm will move to the cleaning position.
5. Clean the touchscreen with alcohol-based disinfection wipes and wipe dry afterwards.
Important: Take care that no liquid runs down the touchscreen. Liquid may be drawn through the dust protection sealing by capillary forces and cause malfunction of the display. To clean the touchscreen, moisten a soft lint-free cloth with 70% ethanol or a mild disinfectant and carefully wipe the display. Depending on the disinfectant, wipe the screen with distilled water. Wipe dry with a paper towel.
6. Clean the outer hood with a soft lint-free cloth moistened with water or mild detergent.

7. Incubate the shaker adapter (grey), shaker tray (metal adapter), buffer bottle rack, and waste drawer in liner (if not done during daily maintenance) by soaking as appropriate. Rinse thoroughly with distilled water and wipe dry with lint-free paper towels. If the shaker rack plugs are used, treat them in the same way.
8. Press **Done** only when the steps listed above have been successfully completed. The date of the last performed monthly maintenance is updated automatically.

Important: Inspect the waste drawer during maintenance. Contact QIAGEN Technical Services if any broken parts are observed.

9. Transfer the run reports from the instrument to the USB flash drive and remove the run reports from the instrument. For details refer to section 5.7, Saving run reports to the USB flash drive.

6.6 Periodic maintenance

The periodic maintenance consists of cleaning the robotic arm modules and centrifuge. It is recommended to be conducted when necessary, but at least every 6 months.

Select the appropriate cleaning agent according to the sample material and downstream assay (refer to section 6.1, Cleaning agents).

6.6.1 Cleaning the robotic arm modules

Cleaning of the robotic arm modules must be performed periodically or could be performed if required. For example, the robotic arm modules must be cleaned if liquids were spilled due to crash.

Note: Perform the monthly maintenance procedure before you perform the robotic arm cleaning procedure.

1. To start cleaning the robotic arm modules, press the **Tools** icon on the menu bar. Press the **Maintenance** tab and select the **Robotic arm** subtab. The screen shows the **Last Executed** maintenance date of the robotic arm modules.

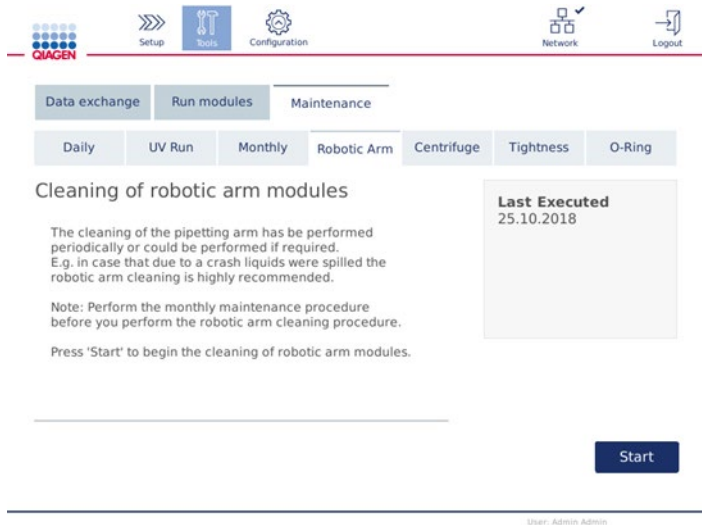

Robotic arm maintenance screen

2. Press **Start** to begin the cleaning of robotic arm modules. Follow the instructions on the screen. Details are provided in the next steps below.
3. Make sure that used Labware, adapters and reagents are removed from the worktable. Close the hood.
4. Press **Next** to move to cleaning position.
5. Remove the waste drawer and open hood.
6. Open the waster drawer. Moisten a soft lint-free cloth with water and carefully clean the optical sensor, tip adapter, gripper unit, rotor adapter stabilization rod and the spin column lid holder. Wipe these items dry as indicated on the touchscreen of the instrument.
7. Close the hood and press **Done** to finish cleaning of robotic arm. The date of the last performed cleaning of robotic arm is updated automatically.

6.6.2 Cleaning the centrifuge

Cleaning of the centrifuge arm must be performed periodically or could be performed if required. For example, the centrifuge must be cleaned in case of plastic crash or spillage of liquids due to crash.

WARNING 	<p>Risk of personal injury and material damage [W5]</p> <p>To prevent plastic crash, load the tubes properly. After a plastic crash, sharp plastic particles could be inside the centrifuge. Be careful when handling items inside the centrifuge.</p>
---	---

Note: Perform the monthly maintenance procedure before you perform the cleaning of centrifuge procedure.

- To start cleaning the centrifuge, press the **Tools** icon and press the **Centrifuge** subtab under the **Maintenance** tab. The screen shows the **Last Executed** centrifuge maintenance date.

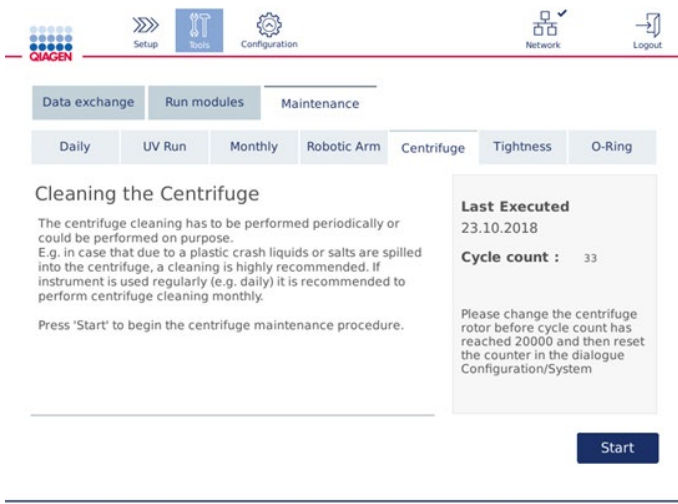

Centrifuge maintenance screen

- Press **Start** to begin the centrifuge cleaning procedure. Follow the instructions on the screen. Details are provided in the next steps below.
- The centrifuge lid must be open to allow access to the inside of the centrifuge. The lid should be opened only after the centrifuge has come to a complete stop. If the lid does not open automatically, close the hood and press the **Open Centrifuge Lid** button.
- Switch off the instrument and perform cleaning as outlined in the following sections (below):
 - Cleaning the rotor and buckets
 - Cleaning the centrifuge
 - Maintenance of the rotor nut
 - Installing the centrifuge rotor and buckets
- When cleaning is completed, turn on the instrument and log in. Press the **Tools** icon and then the **Maintenance** tab. Select the **Centrifuge** subtab.
- Press **Start** again then press **Done** to confirm cleaning. The date of the last performed cleaning of centrifuge is updated automatically.

Cleaning the rotor and buckets

Note: Ensure that the instrument is switched off during cleaning.

1. Make sure the QIAcube Connect MDx is switched off.
2. Remove all disposable rotor adapters, including tubes and spin columns, from the buckets.
3. Remove the buckets from the rotor. Undo the rotor nut on top of the rotor using the rotor key, and carefully lift the rotor off the rotor shaft.



Rotor key

4. Submerge the rotor, buckets and rotor nut in cleaning agent. Incubate as appropriate.
5. Rinse thoroughly with distilled water. Use a brush (e.g., a toothbrush or tube brush) to clean any parts that are difficult to access, such as the bucket mount and the rotor head. Wipe surfaces dry with a soft lint-free cloth. If available, dry the buckets and rotor with pressurized air.



Brushing a bucket

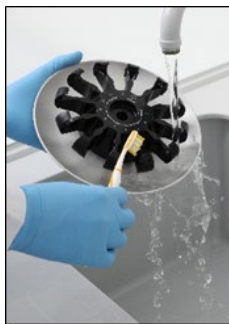

Brushing the rotor

Important: Make sure the paper towels and brush used are lint-free.

Important: Make sure that all residual salt is removed.

Important: Make sure to remove all traces of cleaning agent from the centrifuge buckets. Residual agent can cause the buckets to jam.

6. Carefully check the rotor for damage. If the rotor is damaged or shows signs of wear or corrosion, do not use the rotor. Contact QIAGEN Technical Services.
7. Apply a few drops of mineral oil (Anti-Corrosion Oil (rotor), cat. no. 9018543) on a soft, lint-free cloth, and wipe the bucket mount and rotor claw. A thin, invisible oil film should cover the bucket mount and rotor claw, but no droplets or smear should be apparent.
8. Apply oil to the rotor claw and to the bucket mount.

Important: Before applying oil to the rotor buckets on the rotor, make sure that the rotor and all buckets are completely dry.



Rotor head



Bucket mounts

Cleaning the centrifuge

Note: Ensure that the instrument is switched off during cleaning.

1. Moisten a soft lint-free cloth with cleaning agent and clean the inside of the centrifuge and the centrifuge gasket. Incubate as appropriate.
2. Clean the inside of the centrifuge and the gasket with distilled water and wipe dry with lint-free paper towels. If available, use a vacuum cleaner.

Important: Make sure the gaskets remain in the proper positions.

3. Clean the centrifuge lid with a soft lint-free cloth moistened with cleaning agent. Incubate as appropriate, clean with water and wipe dry with paper towels.
4. Check the centrifuge gasket for damage. If the gasket is damaged or shows signs of wear, contact QIAGEN Technical Services.

Maintenance of the rotor nut

Note: Ensure that the instrument is switched off during cleaning.

Note: Always perform the cleaning procedure after disassembly of the rotor and at least twice a year.

After cleaning the rotor thread, apply a few drops of mineral oil (Anti-Corrosion Oil (rotor), cat. no. 9018543) on a lint-free cloth, and wipe the thread. A thin, invisible oil film should cover the rotor thread but no droplets or smear should appear.

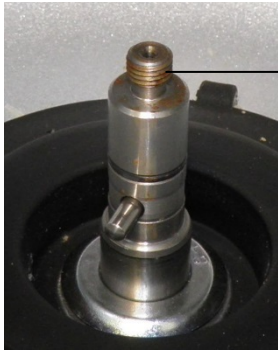

Rotor
thread

Rotor thread.

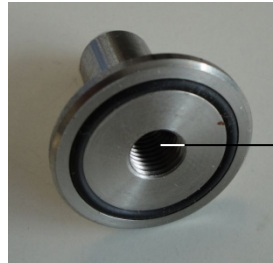

Inner
thread

Inner thread of the rotor nut.

After cleaning the inner thread of the rotor nut, wipe the thread using Anti-Corrosion Oil as described above.

Installing the centrifuge rotor and buckets

Note: Ensure that the instrument is switched off during cleaning.

1. Mount the rotor.
2. The rotor can be mounted in only one orientation. The pin on the rotor shaft fits into a notch on the underside of the rotor directly underneath rotor position 1. Line up position 1 of the rotor with the pin on the rotor shaft and carefully lower the rotor onto the shaft.
3. Install the rotor nut on top of the rotor and tighten securely using the rotor key supplied with the QIAcube Connect MDx. Make sure that the rotor is securely seated.



Rotor key.



Rotor nut.

If the rotor nut is not tightened properly, it can become loose during operation of the centrifuge and can cause serious damage to the instrument. Such damage is not covered by the warranty.

WARNING 	Risk of personal injury and material damage [W25] To prevent the rotor nuts from loosening during operation of the centrifuge, securely tightened the nuts using the rotor key supplied with QIAcube Connect MDx.
---	---

- Insert the rotor buckets. The side of the rotor bucket that must face toward the rotor shaft is marked with a grey line. Hold the bucket at an angle with the grey line facing the center of the rotor and hang the bucket on the rotor. Check that all buckets are properly suspended and can swing freely.

Important: All centrifuge buckets must be mounted before starting a run.

Before starting next protocol run, follow the instructions in section 6.6.3, Operating the centrifuge after cleaning.

6.6.3 Operating the centrifuge after cleaning

The centrifuge must be operated independently before starting further runs to check if residual plastic parts are still in the centrifuge.

Note: Rotor adapters and other consumables are not required.

- Switch the instrument on and log in.
- To start a centrifuge run, press the **Tools** icon on the menu bar and then the **Run Modules** tab. The centrifuge tab is open by default.

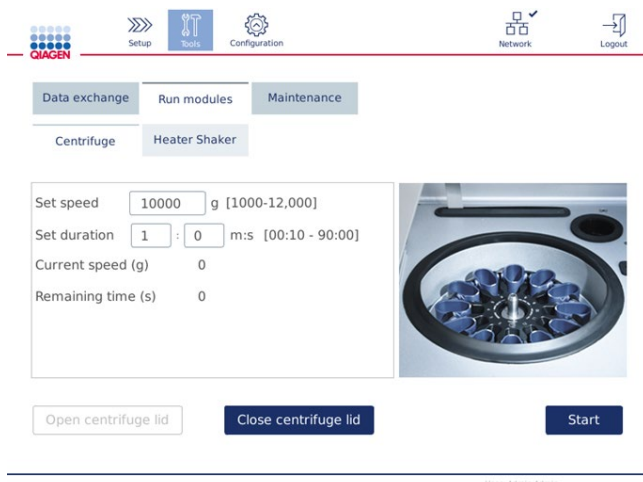

Run Modules screen

- In the **Set speed** and **Set duration** fields, set the speed to 10,000 g and the duration to 1 min (1:0 m:s), respectively.

4. Press **Start** to begin the centrifuge run.
5. Carefully listen to the sound during centrifugation. See below for more details regarding the sound.

Unusual sound during centrifugation

If any grinding, rattling or crunching sounds are heard during the centrifugation, there could be still loose plastic particles inside the centrifuge. Repeat the cleaning procedure as described in section 6.6.2, Cleaning the centrifuge.

Note: It may be necessary to repeat the procedure several times to remove all plastic particles.

No unusual sound during centrifugation

If no unusual sound from loose plastic particles can be heard during centrifugation, the next protocol run can be started.

Note: The **Open centrifuge lid** and **Close centrifuge lid** buttons are not needed to start a centrifuge run, as the lid will close automatically. Instead, they are needed in case you need to prepare the QIAcube Connect MDx for shipment or during troubleshooting.

6.7 Optional Maintenance

6.7.1 UV run

The UV run is recommended to be performed daily for decontamination purposes. It helps to reduce possible pathogen or nucleic acid contamination of the QIAcube Connect MDx worktables. The efficiency of inactivation is to be determined for each specific organism and depends, for example, on layer thickness and sample type. QIAGEN cannot guarantee complete eradication of specific pathogens.

During UV decontamination, the robotic arm will move slowly across the worktable. The default cycle number is 1 (approximately 12 minutes) for maintenance. In case splashes were visible on the worktable after the run, you must increase the cycle number based on used sample material/pathogens.

Note: Before starting the UV irradiation procedure, ensure that daily maintenance (see section 6.4, Daily maintenance) is performed and thereby all samples, eluates, reagents and disposable labware are removed from the worktable and the worktable has been wiped.

During each cycle, an average summed dose rate of 28 to 46 mW*s/cm² can be achieved by UV LED light.

1. To start the UV decontamination, press the **Tools** icon on the menu bar. Press the **Maintenance** tab and select the **UV Run** subtab. The screen shows the **Last Executed** UV run date and the **Cycle duration**.

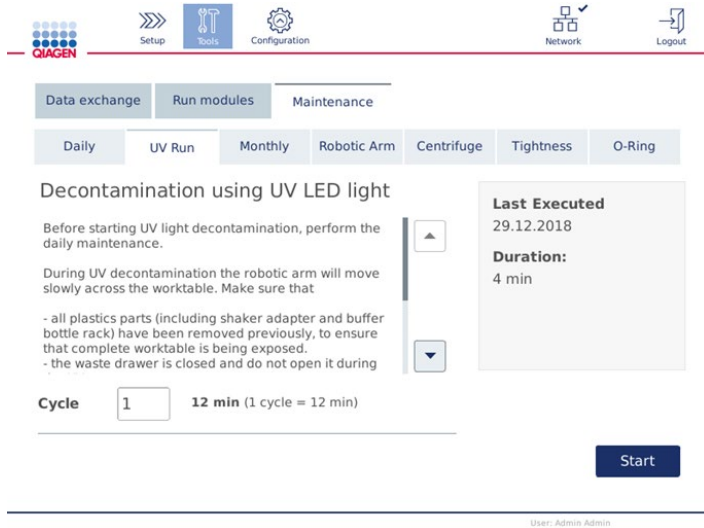

UV run screen

2. In the **Cycle** field, change the number of cycles. The default cycle number is 1 (approximately 12 minutes).
3. Ensure that all disposable labware has been removed from the worktable.
Important: Ensure that the waste drawer is closed. Do not open it during the UV run.
4. Close the hood and press **Start** to begin the UV run.
5. Press **Done** once the UV run is completed. The date of the last performed UV-run is updated automatically.

<p>WARNING</p> 	<p>Risk of personal injury</p> <p>Do not expose your skin to UV-C light from the UV LED lamp.</p>	<p>[W29]</p>
---	--	---------------------

6.7.2 Tightness test

To ensure that the tightness of the tip adapter is sufficient for accurate pipetting, the tightness test of the tip adapter must be performed. This test must also be performed after replacing a tip adapter O-Ring to verify if replacement is successful.

Note: Perform the daily maintenance and cleaning of the robotic arm procedure before you perform the tightness test. See section 6.4, Daily maintenance and section 6.6.1, Cleaning the robotic arm modules.

1. To start the tightness test, press the **Tools** icon on the menu bar. Press the **Maintenance** tab and select the **Tightness** subtab. The screen shows the **Last Executed** tightness test date.

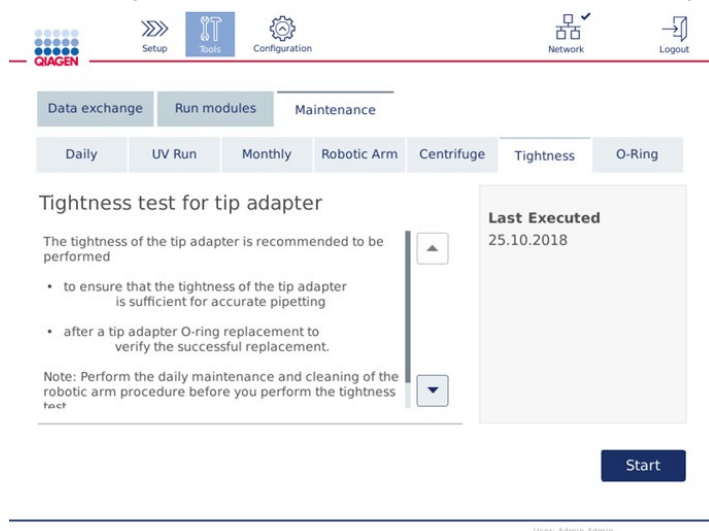

Tightness test screen

2. Press **Start** to begin with the tightness test procedure. Follow the instructions on the screen. Details are provided in the next steps below.
3. Open the hood and load a 1000 µl tip rack with at least one 1000 µl tip into tip rack position 1.
4. Place an empty 2 ml safe-lock microcentrifuge tube (cat. no. 990381) in position 1 of the shaker (shaker type 2).
5. Place a buffer bottle filled with ≥10 ml 96–100% ethanol in position 1.
6. Close the hood and press **Next** to start tightness test.
After the load check, the robotic arm will pick up a tip, aspirate ethanol and move to the tube. The tip will remain in place above the tube for 2 minutes. The tip will be discarded into the waste afterwards.

7. Wait until the test has been completed and then press **Next**.
8. After the protocol is completed, open the QIAcube Connect MDx hood and remove the buffer bottle and tips to store them accordingly.
9. Remove the tube and visually check if liquid is present:
If no liquid is present, press **Yes** to record that the test passed.
If liquid is present, press **No** to record that the test failed.
10. In case the test failed, repeat the test. If test fails again, it is recommended to replace the O-Ring first (see section, 7.3.5 O-Ring exchange) or contact QIAGEN Technical Services.
11. Press **Done** to finalize tightness test procedure. The date of the last performed tightness test is updated automatically.

6.8 Decontaminating the QIAcube Connect MDx

If the QIAcube Connect MDx is contaminated with infectious material, it should be decontaminated. If hazardous material is spilt on or inside the QIAcube Connect MDx, the user has responsibility for carrying out appropriate decontamination.

The QIAcube Connect MDx should also be decontaminated before shipping (e.g., back to QIAGEN). In this case, a decontamination certificate must be completed to confirm that the decontamination procedure has been carried out.

To decontaminate the QIAcube Connect MDx, follow the daily, monthly, and periodic maintenance procedure in sections 6.4, 6.5, and 6.6 using the recommended disinfection agents. In addition, perform a UV run with at least 5 cycles as outlined in section 6.7.1, UV run.

6.9 Servicing

Contact your local QIAGEN Field Service Specialist or your local distributor for more information about flexible Service Support Agreements from QIAGEN.

<p>WARNING</p> 	<p>Risk of personal injury and material damage [W1]</p> <p>Improper use of the QIAcube Connect MDx may cause personal injuries or damage to the instrument. The QIAcube Connect MDx must only be operated by qualified personnel who have been appropriately trained.</p> <p>Servicing of the QIAcube Connect MDx must only be performed by a QIAGEN Field Service specialist.</p>
---	---

7 Troubleshooting

This section provides information about what to do if an error occurs while using the QIAcube Connect MDx.

7.1 Contacting QIAGEN Technical Services

Whenever encountering a QIAcube Connect MDx error, be sure to have the following information at hand:

- Protocol name and version (found in the report file)
- Software version (see section, 5.12 Updating software).
- Serial number of the instrument can be found at the right of the **System** tab in the configuration screen.
- Sample input material
- Detailed description of the error situation

This information will help you and your QIAGEN Technical Service Specialist to deal most efficiently with your issue.

Note: Information about the latest software and protocol versions can be found at www.qiagen.com. In some cases, updates may be available for addressing specific problems.

7.2 Creating a support package

The support package is a zip file that can be sent to QIAGEN Technical Services for diagnosis and trouble shooting.

1. On the menu bar, press the **Tools** icon (.
2. Press the **Data Exchange** tab.

3. Connect the USB flash drive to one of the 2 USB ports next to the touchscreen.

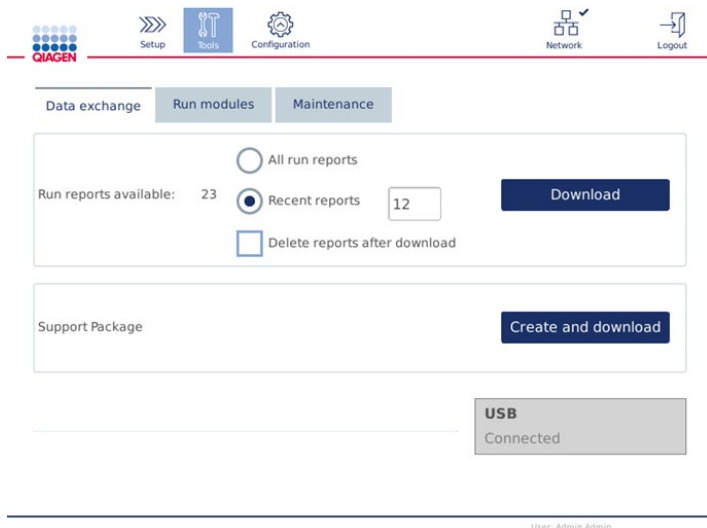

Data exchange screen

4. Press **Create and Download**. The support package will be created and saved on the USB flash drive in the **Support_Package** folder. The support package will contain all relevant data from the last 6 weeks including protocols, run reports, the audit trail and log files.

7.3 Operation

Comments and suggestions

Centrifuge

Bucket does not swing back into place

Clean the centrifuge and rotors as described in section 6, Cleaning and Maintenance.

Imbalance detected

Make sure the rotor is symmetrically loaded according to instructions on run setup screens. Remove the rotor and check the centrifuge chamber for loose plasticware. Power OFF the QIAcube Connect MDx, wait for a few minutes, and power it ON again. If the error persists, contact QIAGEN Technical Services.

Imbalance detected; loud noise heard during centrifugation

Ensure that loose parts are cleared from the worktable prior to centrifuge operation to avoid loose parts jamming or damaging the centrifuge.

Shaker

Incorrect repositioning of shaker

The shaker should re-position itself towards the right side once shaking is completed. Remove any obstructions that prevent the shaker from returning to the correct position.

Comments and suggestions

Robotic arm

Robotic arm does not return to set position	Ensure that the instrument is placed on a stable, flat and level surface as described in section 4.1.1, Site requirements. In other cases, contact QIAGEN Technical Services.
Instrument loading	In case of incorrect instrument loading, thoroughly read the error message. It will guide you to the missing/wrong item.

Pipettor

Pipet tips not picked up by automatic pipettor	Make sure that the tip rack is not damaged and is correctly positioned on the worktable.
Pipet tips not disposed of correctly	Empty the waste drawer and ensure it is not broken. Check that tip disposal slot is not damaged or obstructed. Perform regular maintenance, as described in section 6.3
Droplets observed on worktable	The pipettor is dripping liquid. Check that the reagent bottles contain the correct buffers and are correctly placed in the reagent bottle rack. Be sure to use the right plasticware. Check the volumes in the sample tubes and tubes of accessory buffer(s), if applicable. Do not exceed the recommended amount of starting material to avoid blocking disposable filter-tips. If tip racks have been refilled, make sure that the correct tips were used. Check tightness of pipettor in maintenance section as described in section 6.7.2, Tightness test. If leakage could be detected, change O-Ring as described in section 7.3.5, O-ring exchange. If issue persists, contact QIAGEN Technical Services.

Mechanical

Frame of instrument is distorted (e.g., uneven, unstable or not level)	Ensure that the instrument is placed on a stable, flat and level surface as described in section 4.1.1, Site requirements.
Hood sensor error: instrument will not function	Ensure the hood is properly closed. The instrument will not function if the hood is open.
Broken instrument hood	Ensure that only the cleaning products as described in section 6, Cleaning and Maintenance are used on the hood.

Comments and suggestions

Waste drawer jams but can still be inserted	Empty the waste drawer. Perform daily maintenance, as described in section 6.4.
Incorrectly inserted waste drawer	Handle the waste drawer with both hands when inserting or removing the drawer.
Pipet tips not disposed of correctly	Make sure the top of the tip disposal slot (refer to section 3.3, Internal features of the QIAcube Connect MDx) is not broken.
Scratches appear on the instrument	Always use the cleaning products as described in section 6, Cleaning and Maintenance. Do not use bleach or ethanol, as they can damage the surface of the instrument.

Electronic

Display does not turn on	Do not touch the display with excessive force or use corrosive chemicals to clean the display surface. Contact QIAGEN Technical Services for repair.
Error when copying files to USB	Power OFF the QIAcube Connect MDx, wait for a few minutes, and power it ON again. Save the file(s) to the USB flash drive again. Check the USB flash drive on a PC to ensure it is functional. If the error persists, contact QIAGEN Technical Services.
USB device not detected	Be sure to use only use the USB stick delivered with the instrument. Power OFF the QIAcube Connect MDx, wait for a few minutes, and power it ON again. Insert the USB flash drive into the USB port. Check the USB flash drive on a PC to ensure it is functional. If the error persists, contact QIAGEN Technical Services.
Login screen not visible when launching instrument	If the touchscreen does not display the login screen, but instead a software update message is shown, power OFF the QIAcube Connect MDx, wait for a few minutes. Ensure that the USB flash drive is not inserted in the USB port. Power ON the QIAcube Connect MDx again. The login screen should be visible. If the error persists, contact QIAGEN Technical Services.

Comments and suggestions

Error displayed when inserting the USB flash drive into a Windows PC

Ignore the message. In most cases, no scan is needed; use the USB flash drive as usual. Do not reformat the USB on the Windows PC. This will lead to complete data loss on the USB flash drive, and it can no longer be used with the QIAcube Connect MDx.

7.3.1 Protocol interruption

If an error occurs during a protocol run, it is possible to continue sample preparation manually.

Important: It is not recommended for QIAGEN DSP/IVD protocols to finish the run manually, the run will be invalid and the sample result from the manual continuation of the protocol must not be used for diagnostic purposes. It is under your responsibility to continue sample processing manually, as this invalidates the whole procedure.

To continue sample processing:

1. Note the step at which the protocol stopped. This is displayed in the touchscreen under **Run Details**.
2. Remove the samples and reagents from the QIAcube Connect MDx.
3. Refer to the appropriate protocol in the relevant kit handbook and continue sample processing manually.

7.3.2 Centrifuge

Opening the centrifuge lid in the event of a breakdown

In case of power failure, the centrifuge lid can be manually opened so that the samples can be removed. To open the centrifuge lid, follow the instructions below.

WARNING 	Moving parts [W19] In case of breakdown caused by power failure, remove the power cord and wait 10 minutes before attempting to manually open the centrifuge lid.
---	---

WARNING 	Risk of personal injury and material damage [W20] Raise the centrifuge lid carefully. The lid is heavy and may cause injury if it falls.
---	--

1. Power OFF the QIAcube Connect MDx.
2. Unplug the power cord from the power outlet. Wait 10 minutes for the rotor to stop.
3. Open the instrument hood.
4. Carefully move the robotic arm to the right side of the worktable, furthest away from the centrifuge lid.
5. Remove the screw protection on top of the centrifuge lid. Using the rotor key, turn the screw counter-clockwise.

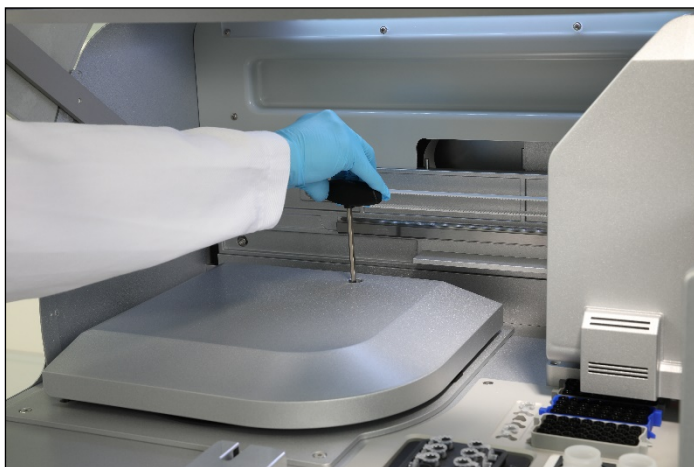

Turning the screw in the centrifuge lid

6. Remove the waste drawer. The centrifuge release cord will be visible on the left side of the waste drawer compartment.

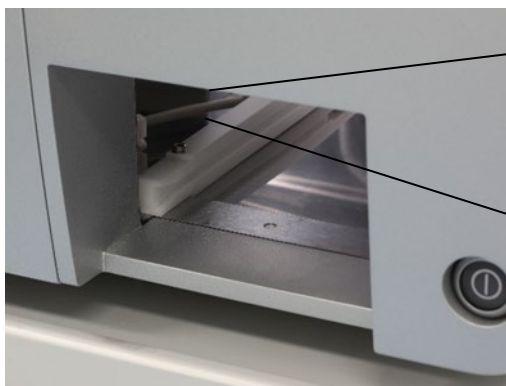

Removed waste drawer



Centrifuge release cord

7. Pull the cord firmly to release the lid from the lock.
8. Manually raise the centrifuge lid.

9. Hold the raised lid and remove the samples and rotor adapters from the rotor.



Removing rotor adapters

Contact QIAGEN Technical Services for instructions on how to reset the lid.

Liquid spills in the centrifuge

The rotor adapter is designed for use with QIAGEN automated protocols. Do not fill the rotor adapters with liquid.

Liquid spills may occur if QIAGEN spin columns become blocked due to sample overloading. Do not exceed the maximum amount of starting material.

Incorrect installation of the centrifuge buckets may also cause rotor adapters to leak. Check that the buckets are installed properly and can swing freely.

If there is a liquid spill in the centrifuge, clean according to the instructions in section 6, *Cleaning and Maintenance*.

7.3.3 Reagent volume detection and ultrasonic pipe

To help prevent errors during detection of reagent volumes, make sure that both rack labeling strips are attached to the reagent bottle rack. These strips ensure that the reagent bottle rack is positioned correctly on the worktable for liquid detection during the load check.

The instrument does not start a load check if the black beam collimator of the ultrasonic sensor is missing. Check if collimator has been installed before starting a load check.



Black beam collimator (see red circle) of the ultrasonic sensor

7.3.4 Touchscreen

Every time the user presses a button on the touchscreen, a small red sign is displayed at the place where the touchscreen recognizes the contact. If the point of touch and the recognized contact are at different positions, a re-calibration of the touchscreen can be performed. The calibration function can be reached during the instrument's startup procedure.

It is recommended to use a touch pen or an unused tip for optimal calibration results. In case you use a tip, discard the tip after calibration.

To re-calibrate the touchscreen:

1. Turn OFF the QIAcube Connect MDx.
2. Wait a few minutes and then turn ON the instrument again.

- In the second screen press the QIAGEN logo.

Note: If you do not press the logo, the instrument will continue initialization.



Press the QIAGEN logo

- Press **Calibrate touchscreen**.

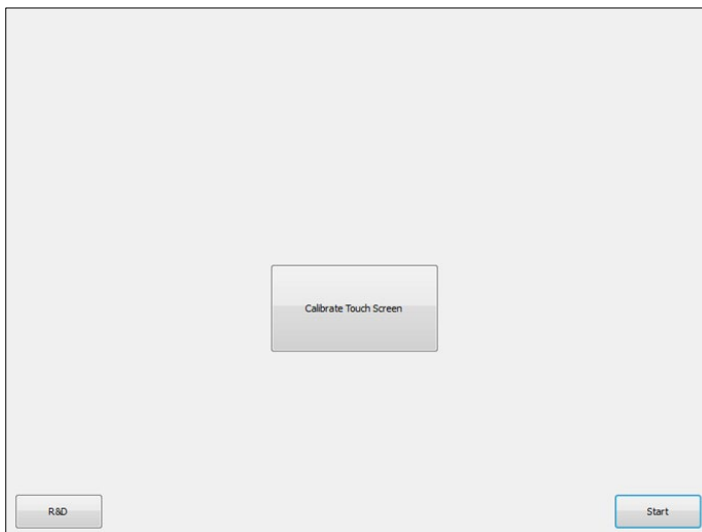

Calibrate Touch Screen Button

- An information message is displayed. The message will close automatically after 10 seconds.

6. Plus signs (+) will be shown at different positions on the screen. For each of these, press the center of the + sign. After one position is touched, the next position will be shown. The graphic below shows the positions and the order in which the + signs will appear.

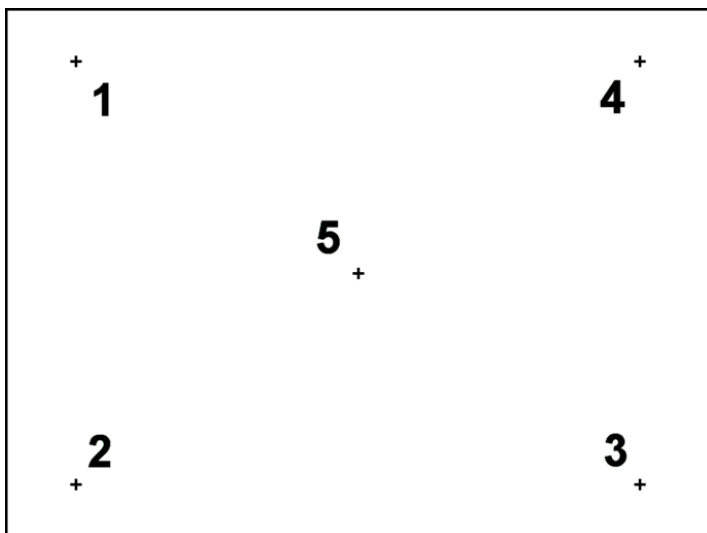

Positions and the order in which the plus signs will appear

7. The calibration is finished after all five positions have been touched. Calibration results are saved automatically. The previous screen is shown again.
8. Press **Start**. The instrument continues initialization using the new calibration settings.
- To cancel the calibration process, turn OFF the QIAcube Connect MDx.

7.3.5 O-Ring exchange

O-Ring replacement must be performed if the tightness test (see section 6.7.2, Tightness test) failed or if the following issues are observed:

- Uneven volume transfers
- Dripping on the worktable

In any case, it is recommended to consult QIAGEN technical service. The replacement procedure requires the O-Ring change tool and an O-Ring. See section 10, Appendix B - QIAcube Connect MDx Accessories, for ordering details.



O-Ring tool with prepared new O-Ring

The O-Ring replacement is semi-automatically and includes movement of robotic arm.

Note: Perform the daily maintenance and cleaning of the robotic arm procedure before you replace the O-Ring.

1. To start the O-Ring replacement, press the **Tools** icon on the menu bar. Press the **Maintenance** tab and select the **O-Ring** subtab. The screen shows the last O-Ring replacement date.

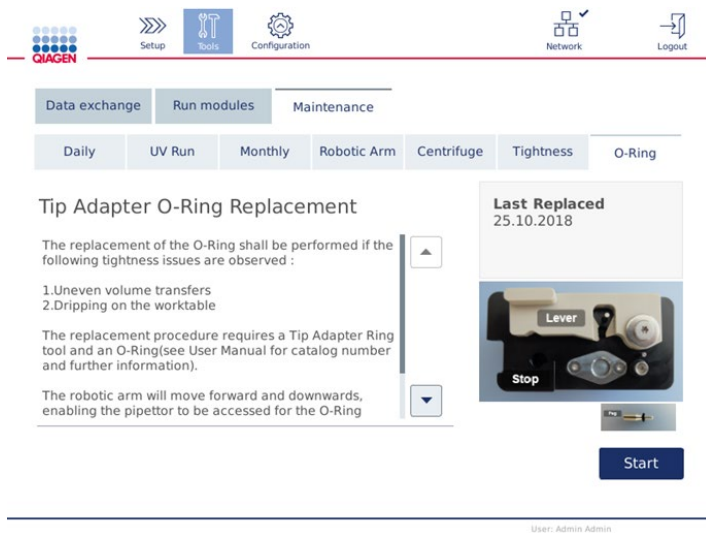

O-Ring maintenance screen

2. Close the hood and press **Start** to begin the O-Ring replacement procedure. Follow the instructions on the screen. Details are provided in the next steps below.

3. To prepare the O-Ring tool, perform the following steps:

3a. Slide the new O-Ring over the small end of the peg.



Slide the new O-Ring

3b. Push the grey lever until you reach the black stop, and insert the small end of the peg into the hole.

3c. Press the peg down using the back end of the tweezers until the O-Ring sits (in the middle) on the larger end of the peg.



Press the peg down using the back end of the tweezers

3d. Open the grey lever and insert the peg with small end first into hole as shown.

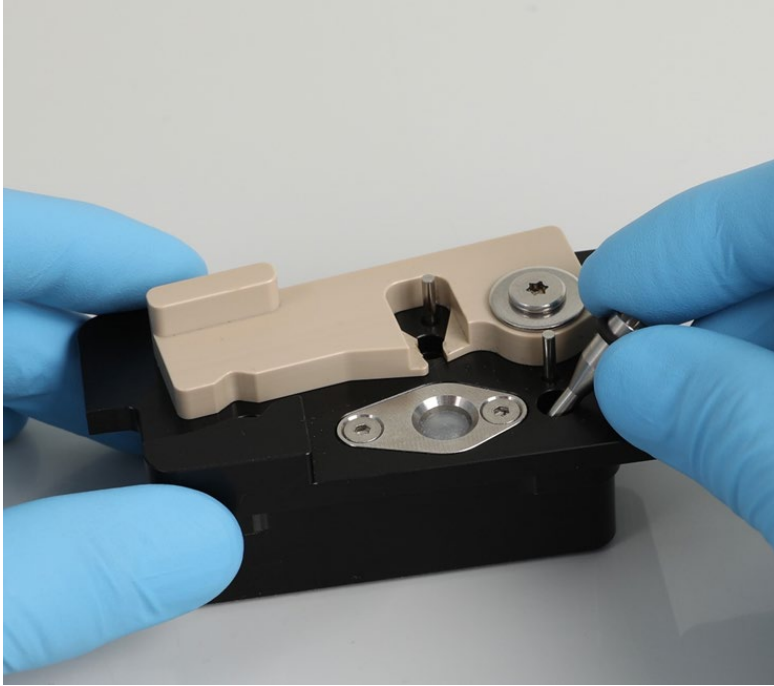

Insert the peg to the hole

4. Press **Next** on the screen and begin loading of the O-Ring tool into the QIAcube Connect MDx.
5. Load the O-Ring tool by opening the grey lever into tip rack position 1 (nearest to user).



Load the O-ring tool

6. Close the hood and press **Next** to begin cutting of the O-Ring.
7. To cut and remove the O-Ring, perform the following steps:

- 7a. To cut the O-Ring, open the hood and rotate the grey lever counter-clockwise until you reach the black stop.

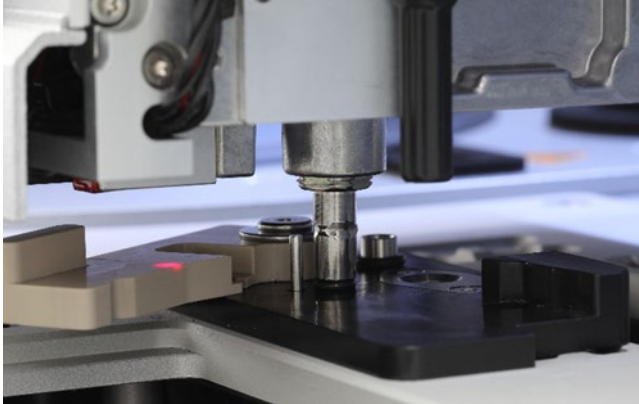

Open the hood

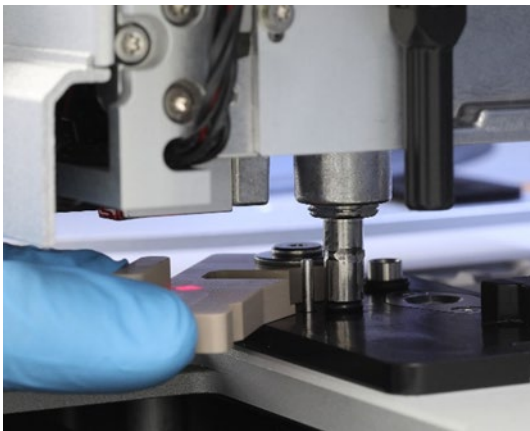

Rotate the grey lever counter-clockwise

- 7b. Open the grey lever and remove the O-Ring (by using the tweezers) from pipetting channel.

Note: If required, repeat cutting process until O-Ring is cut completely and can be removed.



Open the grey lever and remove the O-Ring using the tweezers

8. Close the hood and press **Next** to pick up the prepared new O-Ring.
9. Open the hood and visually check if new O-Ring sits firmly on tip adapter.

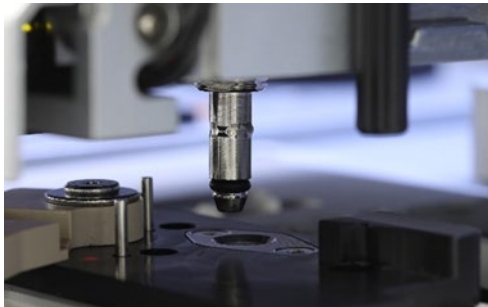

Check if the new O-Ring sits firmly

Note: If the O-Ring was not successfully picked up, complete the O-Ring replacement procedure and restart.

10. Close the hood press **Next** to remove the O-Ring change tool.
11. Open the hood and remove the O-Ring change tool.
12. Wipe and clean the O-Ring change tool with alcohol-based disinfection wipes. Incubate as appropriate, rinse thoroughly with distilled water and wipe dry with lint-free paper towels.
13. Press **Done** to complete the O-Ring replacement. The date of the last performed O-Ring replacement is updated automatically.

<p>WARNING</p> 	<p>Risk of personal injury and material damage [W1]</p> <p>Improper use of the QIAcube Connect MDx may cause personal injuries or damage to the instrument. The QIAcube Connect MDx must only be operated by qualified personnel who have been appropriately trained. Servicing of the QIAcube Connect MDx must only be performed by a QIAGEN Field Service specialist.</p>
---	--

8 Glossary

Term	Description
Centrifuge	A component of the QIAcube Connect MDx that accommodates a rotor with 12 swing-out buckets. Each bucket holds a disposable rotor adapter.
Disposal slots	Slots in the QIAcube Connect MDx worktable through which used tips and columns (e.g., QIAshredder columns) are discarded into the waste drawer.
Hood	The main door at the front of the QIAcube Connect MDx. When open, it provides complete access to the worktable.
Error code	A 3- or 4-digit number that indicates an error of the QIAcube Connect MDx.
Filter-tip	An item of labware that is picked up by the tip adapter during operation of the QIAcube Connect MDx. Liquid is aspirated into and dispensed from a filter-tip.
Initialization	An operation performed automatically when the QIAcube Connect MDx is switched on and if required before each protocol run to check the operation of the QIAcube Connect MDx.
Microcentrifuge tube slots	Three slots located in the labware tray that accommodate accessory buffers, in 1.5 ml or 2 ml microcentrifuge tubes.
Pipetting system/ Pipettor unit	The component of the QIAcube Connect MDx that aspirates and dispenses liquid. The pipetting system moves up and down above the worktable and contains a syringe pump that is connected to a tip adapter.
Power switch	A button located at the front of the QIAcube Connect MDx in the bottom-right corner. It allows the user to switch the QIAcube Connect MDx on and off; inner position is ON and outer position is OFF.
Protocol	A set of instructions for the QIAcube Connect MDx that allows the instrument to automate a nucleic acid or protein purification procedure. Protocols are run using the touchscreen.
Reagent bottle rack	A rack that can accommodate six 30 ml bottles on the QIAcube Connect MDx worktable.

Term	Description
Robotic gripper	A component of the QIAcube Connect MDx robotic arm that moves spin columns during sample processing.
Rotor adapter	A disposable plastic adapter that fits into a centrifuge bucket and holds a QIAGEN spin column and microcentrifuge tube during sample processing.
Tip adapter	A metal probe installed on the pipettor head. During operation of the QIAcube Connect MDx, the tip adapter picks up filter-tips from the worktable.
Tip disposal slots	Slots in the QIAcube Connect MDx worktable through which used filter-tips are discarded into the waste drawer.
Tip rack	A plastic rack that accommodates filter-tips on the worktable.
Touchscreen	The user interface that allows the user to operate the QIAcube Connect MDx.
Waste drawer	A drawer that collects used filter-tips and disposable columns.
Worktable	The surface of the QIAcube Connect MDx where samples, reagents, and filter-tips are loaded.

9 Appendix A – Technical data

QIAGEN reserves the right to change specifications at any time.

9.1 Operating conditions

Power	100–240 V AC, 50/60 Hz, 650 VA Mains supply voltage fluctuations are not to exceed 10% of nominal supply voltages. Note: The apparent power can exceed 650 VA for up to 2 seconds during the centrifuge acceleration and can reach an approximate value of 1000 VA.
Fuse	2x T8A L 250V
Overvoltage category	II
Air temperature	20 to 25°C (68 to 77°F)
Relative humidity	20–75% (noncondensing)
Altitude	Up to 2000 m (6500 ft.)
Place of operation	For indoor use only
Pollution level	2
Environmental class	3K20 (IEC 60721-3-3)

9.2 Transport conditions

Air temperature	–25°C to 60°C (–13°F to 140°F) in manufacturer’s package
Relative humidity	Max. 75% (noncondensing)

9.3 Storage conditions

Air temperature	5°C to 40°C (41°F to 104°F) in enclosed location
Relative humidity	Max. 75% (noncondensing)

9.4 Mechanical data and hardware features

Dimensions (hood closed)	Width: 65 cm (25.6 in.) Height: 58 cm (22.8 in.) Depth: 62 cm (24.4 in.)
Dimensions (hood open)	Width: 65 cm (25.6 in.) Height: 86 cm (34 in.) Depth: 62 cm (24.4 in.)
Mass	QIAcube Connect MDx: 71.5 kg (157.6 lb.) Accessories: 3 kg (6.6 lb.)
Centrifuge	10,640 rpm maximum 12,000 <i>x g</i> maximum Swing-out rotor, maximum 45° 12 rotor positions
Shaker	Speed 100–2000 RPM Amplitude 2 mm Heating range of ambient temperature to 70°C (158°F) Ramp-up time of <5 minutes from ambient temperature to 55°C (±3°C) Difference in the temperature detected by the internal sensor and the temperature of the sample liquid is approximately –2°C
Pipetting system	Syringe size 1 ml Pipetting range 5–900 µl
Capacity	Up to 12 samples per run
Touchscreen	10.4" TFT Touchscreen, active area 211.2 x 158.4 mm, resolution 800*600 SVGA
USB flash drive	USB2.0 Compatible OS: Windows 8, Windows 7, Windows Vista, Windows XP (SP3 or later); Mac OS X 10.1 or later Operating temperature range: 0 to 35°C Operating humidity range: 10 to 90% (with no condensation) Storage temperature range: –20 to 60°C (–4 to 140°F) Storage humidity range: 10 to 90% (with no condensation) Formatting: FAT32
UV LED	Wavelength: 278 nm Optical power: 200–300 mW

Barcode scanner	Scan Pattern: Area Image (838 x 640-pixel array) Motion Tolerance: Up to 610 cm/s (240 in/s) for 13 mil UPC at optimal focus Symbol Contrast: 20% minimum reflectance difference Decode Capability: Reads standard 1D, PDF, 2D, Postal and OCR symbologies
Software	QIAGEN protocols are preinstalled on the QIAcube Connect MDx or can be downloaded at https://www.qiagen.com/products/qiacube-connect-mdx , see the Product Resources tab.

9.5 Declaration of Conformity

Name and address of the legal manufacturer:

QIAGEN GmbH
QIAGEN Strasse 1
40724 Hilden
Germany

An up-to-date declaration of conformity can be requested from QIAGEN Technical Services.

9.6 Waste Electrical and Electronic Equipment (WEEE)

This section provides information about disposal of waste electrical and electronic equipment by users.

The crossed-out wheeled bin symbol (see below) indicates that this product must not be disposed of with other waste; it must be taken to an approved treatment facility or to a designated collection point for recycling, according to local laws and regulations.

The separate collection and recycling of waste electronic equipment at the time of disposal helps to conserve natural resources and ensures that the product is recycled in a manner that protects human health and the environment.



Recycling can be provided by QIAGEN upon request at additional cost. In the European Union, in accordance with the specific WEEE recycling requirements and where a replacement product is being supplied by QIAGEN, free recycling of its WEEE-marked electronic equipment is provided.

To recycle electronic equipment, contact your local QIAGEN sales office for the required return form. Once the form is submitted, you will be contacted by QIAGEN either to request follow-up information for scheduling collection of the electronic waste or to provide you with an individual quote.

9.7 EMC Declaration

The IVD medical equipment complies with the emission and immunity requirements described in IEC 61326-2-6.

The “United States Federal Communications Commission” (USFCC) (in 47 CFR 15. 105) declared that the users of this product must be informed of the following facts and circumstances.

“This device complies with part 15 of the FCC:

Operation is subject to the following two conditions: (1) This device may not cause harmful interference, and (2) this device must accept any interference received, including interference that may cause undesired operation.”

“This Class B digital apparatus complies with Canadian ICES-0003.”

The following statement applies to the products covered in this manual, unless otherwise specified herein. The statement for other products will appear in the accompanying documentation.

Note: This equipment has been tested and found to comply with the limits for a Class B digital device, pursuant to Part 15 of the FCC Rules and meets all requirements of the Canadian Interference-Causing Equipment Standard ICES-003 for digital apparatus. These limits are designed to provide reasonable protection against harmful interference in a residential installation. This equipment generates, uses, and can radiate radio frequency energy and, if not installed and used in accordance with the instructions, may cause harmful interference to radio communications. However, there is no guarantee that the interference will not occur in an installation. If this equipment does cause harmful interference to radio or television reception, which can be determined by turning the equipment off and on, the user is encouraged to try to correct the interference by one or more of the following measures:

- Reorient or relocate the receiving antenna.
- Increase the separation between the equipment and receiver.
- Connect the equipment into an outlet on a circuit different from that to which the receiver is connected.
- Consult the dealer or an experienced radio/TV technician for help.

QIAGEN GmbH Germany is not responsible for any radio television interference caused by unauthorized modifications of this equipment or the substitution or attachment of connection cables and equipment other than those specified by QIAGEN GmbH, Germany. The correction of interference caused by such unauthorized modification, substitution or attachment will be the responsibility of the user.

9.8 Liability Clause

QIAGEN shall be released from all obligations under its warranty in the event repairs or modifications are made by persons other than its own personnel, except in cases where the Company has given its written consent to perform such repairs or modifications.

All materials replaced under this warranty will be warranted only for the duration of the original warranty period, and in no case beyond the original expiration date of original warranty unless authorized in writing by an officer of the Company. Read-out devices, interfacing devices, and associated software will be warranted only for the period offered by the original manufacturer of these products. Representations and warranties made by any person, including representatives of QIAGEN, which are inconsistent or in conflict with the conditions in this warranty shall not be binding upon the Company unless produced in writing and approved by an officer of QIAGEN.

The QIAcube Connect MDx is equipped with an Ethernet port and a Wi-Fi USB device. The Purchaser of the QIAcube Connect MDx is solely responsible for preventing any and all

computer viruses, worms, trojans, malware, hacks, or any other type of cybersecurity breaches. QIAGEN assumes no liability for computer viruses, worms, trojans, malware, hacks, or any other type of cybersecurity breaches.

10 Appendix B – QIAcube Connect MDx Accessories

For more information and an up-to-date list of available protocols, visit <https://www.qiagen.com/products/qiacube-connect-mdx> and go to the **Product Resources** tab.

Ordering Information

Product	Contents	Cat. no.
QIAcube Connect MDx	Instrument and 1-year warranty on parts and labor	9003070
QIAcube Connect MDx System FUL-2	Instrument and service agreement package: includes installation, application training, Full Agreement for two years with a two business day response time and two inspection service visits.	9003071
QIAcube Connect MDx System FUL-3	Instrument and service agreement package: includes installation, application training, Full Agreement for three years with a two business day response time and three inspection service visits.	9003072
QIAcube Connect MDx System PRV-1	Instrument and service agreement package: includes installation, application training and one preventive maintenance visit. One-year warranty on labor, travel and parts also included.	9003073
QIAcube Connect MDx Device PRV-1	Instrument and service agreement package: includes one inspection service visit. One-year warranty on labor, travel and parts are also included. Does not include installation and training.	9003074
QIAcube Connect MDx System PRM-1	Instrument and service agreement package: includes installation, application training, Premium Agreement for 1 year with a next business day response time and 1 inspection service visit.	9003075
QIAcube Connect Premium Agreement	On-site repair service with next business day response time. Includes 1 Inspection Service and travel, labor, and parts	9245209
QIAcube Connect Full Agreement	On-site repair service with two business day response time. Includes 1 Inspection Service and travel, labor, and parts	9245208
QIAcube Connect Core Agreement	On-site repair service and one on-site Inspection Service, including travel, labor and spare parts for a period of 1 year. Response time of five business days. Includes 10% discount on additional repair service during the agreement period.	9245260

QIAcube Connect, Installation	On-site installation and setup of instrument hardware and system software. Training demonstrating routine maintenance, basic troubleshooting, and more for up to 4 laboratory staff members.	9245211
Starter Pack, QIAcube	200 µl filter-tips (1024); 1000 µl filter-tips (1024); 30 ml reagent bottles (12); rotor adapters (240); 1.5 ml elution tubes (240); rotor adapter holder (1)	990395
QIAcube Connect IQ/OQ	On-site installation qualification and operational quality service.	9245232
Accessories		
Filter-Tips, 1000 µl (1024)	Disposable Filter-Tips, racked; (8 x 128)	990352
Filter-Tips, 1000 µl, wide-bore (1024)	Disposable Filter-Tips, wide-bore, racked; (8 x 128); not required for all protocols	990452
Filter-Tips, 200 µl (1024)	Disposable Filter-Tips, racked; (8 x 128); not required for all protocols	990332
Rotor, centrifuge	Rotor for the QIAcube centrifuge	9017848
Swing-out Buckets	Swing-out buckets for the rotor of the QIAcube centrifuge	9017849
Rotor Adapters (10 x 24)	For 240 preps: 240 Disposable Rotor Adapters and 240 microcentrifuge tubes (1.5 ml); for use with the QIAcube Connect MDx	990394
Rotor Adapter Holder	Holder for 12 disposable rotor adapters; for use with the QIAcube Connect MDx	990392

Product	Contents	Cat. no.
Reagent Bottle Rack	Rack for accommodating 6 x 30 ml reagent bottles on the QIAcube Connect MDx worktable	990390
Reagent Bottles, 30 ml (6)	Reagent Bottles (30 ml) with lids; pack of 6; for use with the QIAcube Connect MDx reagent bottle rack	990393
Shaker Rack Plugs (12)	For use with 2 ml screw cap tubes	9017854
Sample Tubes RB (2 ml)	1000 safe-lock microcentrifuge tubes (2 ml) for use with the QIAcube Connect MDx	990381
Sample Tubes CB (2 ml)	1000 conical screw-cap tubes without skirted base (2 ml) for use with the QIAcube Connect MDx	990382
USB flash drive	USB flash drive; for use with the QIAcube Connect MDx	9017850
O-Ring Change Tool	O-Ring change tool for use with the QIAcube Connect MDx	9026181
O-Ring Set	Set of 10 O-Rings for use with the QIAcube Connect MDx	9018472
Spin Column Adapter Rings (25)	Spin column adapter rings for use with spin-columns that have screw-caps; not required for all protocols	990399

For up-to-date licensing information and product-specific disclaimers, see the respective QIAGEN kit handbook or user manual. QIAGEN kit handbooks and user manuals are available at www.qiagen.com or can be requested from QIAGEN Technical Services or your local distributor.

11 Version history

Document	Date	Description
HB-2794-001	December 2020	Initial Release of QIAcube Connect MDx User Manual

Index

- About this user manual, 6
- Accessories, 148
- Cautions, 9
- Centrifuge, 30
- Centrifuge operation, 92
- Centrifuge rotor and buckets installation, 43
- Changing password, 105
- Cleaning agents, 108
- Configuration, 45
 - Changing password, 105
 - LAN, 49
 - Managing protocols, 95
 - Network, 49
 - Q-Base connection, 49
 - Software update, 98
 - System data, 46
 - User settings, 48
 - Wi-Fi, 51
- Cooling air outlet, 28
- Creating a support package, 125
- Declaration of Conformity, 144
- Decontaminating the instrument, 124
- Disinfecting the instrument, 108
- External features of QIAcube Connect, 24
- FCC Declaration, 145
- General Description, 21
- Glossary, 140
- Grounding requirements, 40
- Heater/shaker operation, 90
- Hood, 25
- Installation, 41
 - Accessories, 41
 - Centrifuge rotor and buckets, 43
 - Connecting to power, 42, 43
 - Grounding requirements, 40
 - Power requirements, 39
 - Shaker adapter, 44
 - Site requirements, 38
 - unpacking, 40
- Installation environment, 38
- Installation procedures, 38
- Instrument administration, 38
- Instrument configuration, 45
- Instrument operation, 55
- Intended use, 7
- Internal features of QIAcube Connect, 29
- LAN configuration, 49
- Liability Clause, 146
- Maintenance
 - Cleaning the centrifuge, 115
 - Cleaning the robotic arm modules, 114
 - Daily maintenance procedure, 111
 - Decontaminating the instrument, 124
 - Monthly maintenance procedure, 113
 - Operating the centrifuge after cleaning, 120
 - O-Ring exchange, 134
 - Periodic maintenance procedure, 114
 - Regular maintenance procedure, 111
 - Tightness test, 123
 - UV decontamination, 121
- Managing protocols, 95
- Microcentrifuge tube slots, 33
- Network configuration, 49
- Operating the centrifuge, 92
- Operating the heater/shaker, 90
- Operation procedures, 55
- Optical sensor, 34
- Packing the instrument, 53
- Pipetting system, 34
- Policy statement, 7
- Power cord socket, 27
- Power requirements, 39
- Power switch, 25
- Q-Base connection, 49
- QIAcube Connect accessories, 148
- QIAcube Connect principle, 22
- QIAcube Connect software, 58
- Reagent bottle rack, 31
- RJ-45 Ethernet port, 25, 29
- Robotic arm, 33
- Robotic gripper, 34
- Rotor adapter, 36
- Safety information, 9
 - Biological safety, 13
 - Centrifuge, 16
 - Chemicals, 14
 - Electrical safety, 11
 - Heat hazard, 17
 - Maintenance, 17
 - Mechanical hazards, 15
 - Operating conditions, 13

- Proper use, 9
- Radiation safety, 19
- Symbols, 20
- Waste disposal, 15
- Saving run reports, 88
- Sensor
 - Optical, 34
 - Ultrasonic, 35
- Servicing, 124
- Setting up a protocol run, 63
- Shaker, 30
- Shaker adapter installation, 44
- Site requirements, 38
- Software update, 98
- Starting the protocol run, 85
- Stopping a protocol run, 87
- Switching on the instrument, 61
- Symbols on the QIAcube Connect, 20
- System data, 46
- Technical assistance, 6
- Technical data, 142
 - Declaration of Conformity, 144
 - FCC Declaration, 145
 - Hardware features, 143
 - Liability Clause, 146
 - Mechanical data, 143
 - Operating conditions, 142
 - Storage conditions, 142
 - Transport conditions, 142
 - WEEE, 144
- Tip disposal slots, 33
- Tip rack slots, 33
- Tip sensor, 33
- Touchscreen, 25
- Touchscreen calibration, 132
- Troubleshooting, 125
 - Centrifuge, 129
 - Creating a support package, 125
 - Instrument operation, 126
 - Protocol interruption, 129
 - Touchscreen calibration, 132
- Ultrasonic sensor, 35
- Unpacking instructions, 40
- USB ports, 26
- User requirements, 7
- User settings, 48
- UV LED, 36
- Version management, 151
- Warnings, 9
- Waste drawer, 26
- Waste Electrical and Electronic Equipment (WEEE), 144
- Wi-Fi configuration, 51

Trademarks: QIAGEN®, Sample to Insight®, QIAcube®, Qproteome® (QIAGEN Group); DNA-ExitusPlus™ (AppliChem); RNaseZap® (Ambion, Inc.); Microsoft®, Windows® (Microsoft Corporation); Gigasepf®, Lysetol®, MikroZid® (Schülke & Mayr GmbH); DECON-QUAT® (Veltek Associates, Inc.). Registered names, trademarks, etc. used in this document, even when not specifically marked as such, are not to be considered unprotected by law.

HB-2794-001 12/2020 1121932 © 2020 QIAGEN, all rights reserved.

www.qiagen.com

Technical Support

www.support.qiagen.com