

May 2018

QIAsymphony[®] SP/AS Consolidated Operating Guide

For use with software version 5.0



CE



QIAGEN GmbH, QIAGEN Strasse 1, 40724 Hilden GERMANY

R1 **MAT**

1107307

Contents

1	Introduction	10
1.1	General information.....	10
1.1.1	Technical assistance.....	10
1.1.2	Policy statement.....	10
1.2	Intended use of QIASymphony SP/AS	11
1.2.1	QIASymphony SP.....	11
1.2.2	QIASymphony AS.....	11
1.3	Requirements for QIASymphony SP/AS users	12
1.3.1	Training for QIASymphony SP/AS users	12
1.4	QIASymphony Cabinet SP/AS	13
1.5	User manual references	13
1.6	Glossary.....	13
1.7	QIASymphony SP/AS accessories	13
2	Safety Information	14
2.1	Proper use	14
2.2	Electrical safety	15
2.3	Environment.....	16
2.3.1	Operating conditions	16
2.4	Waste disposal	16
2.5	Biological safety.....	17
2.5.1	Samples	17
2.6	Chemicals.....	17
2.6.1	Toxic fumes.....	18
2.7	Mechanical hazards	18
2.8	Heat hazard	19
2.9	Maintenance safety	19
2.10	Radiation safety	21
2.11	Symbols on the QIASymphony SP/AS instruments.....	21

3	Startup Procedure.....	25
3.1	Site requirements.....	25
3.1.1	Workbench.....	25
3.2	General features.....	26
3.2.1	Hood(s).....	26
3.2.2	Touchscreen.....	26
3.2.3	USB ports.....	26
3.2.4	Network interface.....	27
3.2.5	Status LEDs.....	27
3.3	Switching on the QIAsymphony SP/AS.....	27
3.3.1	Getting started.....	27
3.3.2	Logging out.....	28
3.3.3	Switching off the QIAsymphony SP/AS.....	29
4	User Settings.....	30
4.1	Configuration settings.....	30
4.2	User accounts.....	30
4.2.1	Create new users.....	31
4.2.2	Activate/inactivate user accounts.....	32
4.2.3	System request for password change.....	32
4.2.4	User request for password change.....	34
4.3	Language package installation.....	35
4.3.1	Setting up the USB stick and transferring language files from the USB stick.....	35
4.3.2	Transferring files using the QMC.....	36
4.3.3	Changing the language on QIAsymphony SP/AS.....	36
4.3.4	Changing the language in QIAsymphony Management Console (QMC).....	37
5	QIAsymphony SP/AS User Interface.....	38
5.1	QIAsymphony SP/AS screen layout.....	38
5.1.1	Status bar.....	38
5.1.2	Tab menus.....	40
5.2	Software symbols.....	41

6	Handling Files.....	42
6.1	Transfer options.....	42
6.2	Data transfer via the USB stick	43
6.3	File transfer from QIASymphony instruments to the USB stick	43
6.4	Transferring files from the USB stick	45
6.5	Synchronizing files	46
6.5.1	Synchronizing files on instruments with files on the USB stick	46
6.5.2	Synchronizing files on the USB stick with files on instruments	47
6.6	Deleting files	48
7	QIASymphony SP Features.....	49
7.1	Workflow principle.....	49
7.1.1	Basic principle	50
7.2	Instrument features	50
7.2.1	Magnetic head.....	50
7.2.2	Lysis station.....	51
7.2.3	Robotic arm	51
7.3	Bar code reader	53
7.3.1	Sample input bar code reader	53
7.3.2	Reagents and consumables 2D bar code reader	53
7.3.3	Bar code types	54
7.3.4	Handheld scanner	54
8	Loading QIASymphony SP Drawers	55
8.1	Using the software Wizard.....	55
8.2	Loading the “Waste” drawer	56
8.2.1	Tip park station	57
8.2.2	Liquid waste container	57
8.2.3	Tip chute	58
8.2.4	Tip waste collection	58
8.2.5	Unit boxes	58
8.2.6	Closing the “Waste” drawer.....	59

8.3	Loading the "Eluate" drawer	60
8.3.1	Features of the "Eluate" drawer	60
8.3.2	Loading procedure	61
8.3.3	Transfer module.....	63
8.3.4	Unloading the "Eluate" drawer.....	65
8.4	Loading the "Reagents and Consumables" drawer	67
8.4.1	Loading consumables.....	67
8.4.2	Reagent cartridges.....	70
8.4.3	Buffer bottle	72
8.4.4	Accessory Trough	73
8.4.5	Unloading reagents and consumables.....	73
8.5	Loading the "Sample" drawer	75
8.5.1	Loading tube carriers	75
8.5.2	Loading the plate carrier	82
8.6	Performing inventory scans (SP).....	83
8.6.1	Inventory scan of the "Reagents and Consumables" drawer.....	83
8.6.2	Inventory scan of the "Waste" drawer.....	85
8.6.3	Inventory scan of the "Eluate" drawer	85
8.7	Starting, pausing, resuming, and stopping a run	86
8.7.1	Starting a run	86
8.7.2	Pausing a run.....	86
8.7.3	Resuming a run	87
8.7.4	Stopping a run	87
8.8	End of batch processing or run.....	87
8.9	End of working day	88
9	QIASymphony SP Run Definitions	89
9.1	Configuring a sample type	89
9.2	Use of virtual bar codes	89
9.3	Defining a batch/run (queuing)	90
9.3.1	Samples loaded in the tube carrier	90

10	QIASymphony AS Features	95
10.1	QIASymphony AS principle.....	95
10.2	Instrument features	96
10.2.1	QIASymphony AS hood.....	96
10.2.2	QIASymphony status LEDs.....	97
10.2.3	Robotic arm	97
11	QIASymphony AS Drawers.....	98
11.1	“Eluate and Reagents” drawer	98
11.1.1	Filter-tips.....	98
11.2	“Assays” drawer	99
12	QIASymphony AS Basic Functions	100
12.1	Definitions	100
12.1.1	Independent operation	100
12.1.2	Integrated operation	101
12.1.3	Run with normalization.....	101
12.1.4	Standard curve.....	102
12.2	Preparing a run	102
12.2.1	Assay favorites.....	102
12.3	Integrated run	103
12.3.1	Defining an integrated run.....	104
12.3.2	Loading an integrated run	112
12.3.3	Checking cooling temperatures (optional).....	122
12.3.4	Starting an integrated run.....	123
12.3.5	Removing assays after an AS run	124
12.3.6	Procedure after run completion.....	125
12.3.7	Pausing, resuming, and stopping an integrated run	125
12.4	Independent run	127
12.4.1	Defining an independent assay run.....	127
12.4.2	Defining/checking sample rack(s).....	131
12.4.3	Defining assay(s) to be processed in the run	135
12.4.4	Assigning selected assays to sample positions.....	137

12.4.5	Modifying assay parameters	140
12.4.6	Queuing an independent assay run	141
12.4.7	Validating the assay run	142
12.4.8	Loading an independent run	142
12.4.9	Checking cooling temperatures	144
12.4.10	Starting an independent run	144
12.4.11	Removing assays after an independent run	145
12.4.12	Pausing, resuming, and stopping an independent run	149
12.5	Performing inventory scans (AS)	150
12.5.1	Inventory scan of "Eluate and Reagents" drawer	150
12.5.2	Inventory scan of the "Assays" drawer	151
12.5.3	Transfer to a PCR cycler	152
13	Troubleshooting	153
13.1	Error messages and warnings	153
13.1.1	Errors indicated in the status bar	153
13.1.2	Errors indicated in the tab headers	153
13.1.3	Errors indicated in the command bar	154
13.1.4	Messages with Help button	154
13.1.5	Messages without Help button	155
13.2	Software help boxes	155
13.2.1	Structure of software help boxes	156
13.3	Contacting QIAGEN Technical Services	157
13.3.1	Make a record of the incident	157
13.3.2	Creating an instrument report file	158
13.4	General errors that do not have error codes	159
13.4.1	File handling errors	159
13.4.2	File errors	160
13.4.3	Tip waste errors	163
13.4.4	Configuration menu errors	163
13.4.5	Inventory scan errors	164

13.5	QIASymphony SP errors that do not have error codes	166
13.5.1	“Eluate” drawer	166
13.5.2	“Sample” drawer	167
13.5.3	“Waste” drawer	167
13.5.4	“Reagents and Consumables” drawer	167
13.5.5	Errors that may occur when starting a batch/run	168
13.5.6	Protocol errors.....	168
13.5.7	Errors that may occur while operating the QIASymphony SP	168
13.5.8	Protocol run interruption	169
13.6	QIASymphony AS errors that do not have error codes.....	170
13.6.1	Assay definition errors	170
13.6.2	Errors occurring during an assay run	171
13.6.3	Data analysis errors	172
13.7	Integrated run errors	172
13.7.1	“Eluate” drawer	172
13.7.2	Removal of an integrated run	173
13.7.3	Maintenance, service, and configuration	173
14	Maintenance	174
14.1	Maintenance scheduler	174
14.1.1	Confirming a maintenance task.....	176
14.1.2	Postponing a maintenance task	176
14.1.3	Configuring the maintenance settings.....	177
14.2	Cleaning	178
14.3	Servicing	179
14.4	Regular maintenance	179
14.4.1	Regular disposal of tips	180
14.4.2	Regular maintenance procedure for the QIASymphony SP	180
14.4.3	Regular maintenance procedure for the QIASymphony AS (integrated and independent)	181

14.5	Daily maintenance (SP/AS)	182
14.5.1	Pipetting system tip guards (SP/AS)	182
14.5.2	Tip disposal chute.....	182
14.5.3	Drawers and lysis station (SP).....	183
14.5.4	Drawers (AS)	184
14.5.5	Conveyor base tray (SP) — optional	184
14.5.6	Robotic gripper (SP)	184
14.5.7	Liquid waste container (SP)	185
14.6	Weekly maintenance (SP/AS)	185
14.6.1	File management	185
14.6.2	Touchscreen.....	185
14.6.3	QIASymphony SP/AS hoods	186
14.6.4	Tube carriers (SP)	186
14.6.5	Optical sensor (SP)	186
14.6.6	Magnetic head (SP)	186
14.6.7	Liquid waste container (SP)	187
14.6.8	Adapters (AS)	187
14.7	UV decontamination of the worktable	188
14.8	Monthly maintenance (SP/AS)	189
15	Technical Data.....	190
15.1	Environmental conditions.....	190
15.2	Mechanical data and hardware features	191
16	User Interface Addendum.....	192
	Appendix	206
	Waste Electrical and Electronic Equipment (WEEE)	207
	FCC declaration.....	208
	Liability clause	209
	Index	210

1 Introduction

Thank you for choosing QIASymphony SP/AS instruments. We are confident that they will become an integral part of your laboratory.

This consolidated operating guide gives you basic information about operating the QIASymphony SP and AS instruments.

Before using the instruments, it is essential to read this consolidated operating guide carefully. The instructions and safety information in the consolidated operating guide must be followed to ensure safe operation of the instruments and to maintain the instruments in a safe condition.

1.1 General information

1.1.1 Technical assistance

At QIAGEN, we pride ourselves on the quality and availability of our technical support. Our Technical Services Departments are staffed by experienced scientists with extensive practical and theoretical expertise in molecular biology and the use of QIAGEN® products. If you have any questions or experience any difficulties regarding the QIASymphony SP/AS instruments or QIAGEN products in general, do not hesitate to contact us.

QIAGEN customers are a major source of information regarding advanced or specialized uses of our products. This information is helpful to other scientists as well as to the researchers at QIAGEN. We therefore encourage you to contact us if you have any suggestions about product performance or new applications and techniques.

For technical assistance, contact QIAGEN Technical Services.

For up-to-date information about QIASymphony SP/AS instruments, visit www.qiagen.com/goto/QIASymphony.

1.1.2 Policy statement

It is the policy of QIAGEN to improve products as new techniques and components become available. QIAGEN reserves the right to change the specifications of products at any time.

1.2 Intended use of QIA Symphony SP/AS

Note: The QIA Symphony SP and AS instruments are intended for use by professional users, such as technicians and physicians trained in molecular biological techniques and the operation of QIA Symphony SP and AS instruments.

1.2.1 QIA Symphony SP

The QIA Symphony SP instrument is designed to perform automated purification of nucleic acids.

It is intended to be used only in combination with QIA Symphony Kits indicated for use with the QIA Symphony SP for the applications described in the kit handbooks.

1.2.2 QIA Symphony AS

The QIA Symphony AS instrument is designed to perform automated assay setup.

If used in combination with QIAGEN kits indicated for use with the QIA Symphony AS instrument, it is intended for the applications described in the respective QIAGEN kit handbooks. If the QIA Symphony AS instrument is used with kits other than QIAGEN kits, it is the user's responsibility to validate the performance of such product combinations for any particular application.

1.3 Requirements for QIASymphony SP/AS users

The following table covers the general level of competence and training necessary for transportation, installation, use, maintenance, and servicing of QIASymphony SP/AS instruments.

Type of task)	Personnel	Training and experience
Delivery	No special requirements	No special requirements
Installation	QIAGEN Field Service Specialists only	Appropriately trained and experienced personnel familiar with use of computers and automation in general
Routine use (running protocols)	Laboratory technicians or equivalent	Professional users, such as technicians and physicians, trained in molecular biology techniques
Routine maintenance	Laboratory technicians or equivalent	Professional users, such as technicians and physicians, trained in molecular biology techniques
Servicing and annual maintenance	QIAGEN Field Service Specialists only	Regularly trained, certified, and authorized by QIAGEN

1.3.1 Training for QIASymphony SP/AS users

Customers are trained by a QIAGEN representative upon installation of the QIASymphony SP/AS instrument(s). The training takes 1–3 days, depending on the subject and the knowledge level of the customer.

Basic training covers general operation of the system, user management, configuration, QIASymphony Management Console (QMC) software, regular maintenance, and basic troubleshooting. Application-specific topics will be addressed in an advanced training.

QIAGEN can also provide retraining, for example, after software updates, or for new laboratory personnel. Please contact QIAGEN Technical Services to get more information about retraining.

1.4 QIASymphony Cabinet SP/AS

The QIASymphony Cabinet SP/AS is an optional accessory for QIASymphony SP/AS instruments. QIASymphony Cabinets are specially designed for positioning the QIASymphony SP/AS instruments in your laboratory. For more information, visit www.qiagen.com/goto/QIASymphony or contact QIAGEN Technical Services.

1.5 User manual references

The following user manuals are referred to in this consolidated operating guide:

- *QIASymphony SP/AS User Manual – General Description*
- *QIASymphony SP/AS User Manual – Operating the QIASymphony SP*
- *QIASymphony SP/AS User Manual – Operating the QIASymphony AS*
- *QIASymphony Management Console User Manual*
- *QIASymphony Cabinet SP/AS User Guide*

1.6 Glossary

For a glossary of terms used in this consolidated operating guide, refer to Section 11 of the *QIASymphony SP/AS User Manual – General Description*.

1.7 QIASymphony SP/AS accessories

For information about QIASymphony SP/AS accessories, refer to Appendix C of the *QIASymphony SP/AS User Manual – General Description*.

2 Safety Information

This consolidated operating guide contains information about warnings and cautions that must be followed by the user to ensure safe operation of the QIASymphony SP/AS instruments and to maintain the instruments in a safe condition.

Possible hazards that could harm the user or result in damage to the instrument are clearly stated at the appropriate places throughout this consolidated operating guide.

If the equipment is used in a manner not specified by the manufacturer, the protection provided by the equipment may be impaired.

The following safety conventions are used throughout this consolidated operating guide.

WARNING The term WARNING is used to inform you about situations that could result in **personal injury** to other persons.
Details about these circumstances are given in a box like this one.



CAUTION The term CAUTION is used to inform you about situations that could result in **damage to an instrument** or other equipment.
Details about these circumstances are given in a box like this one.



The advice given in this manual is intended to supplement, not supersede, the normal safety requirements prevailing in the user's country.

2.1 Proper use

The QIASymphony SP/AS must only be operated by qualified personnel who have been appropriately trained.

Servicing of the QIASymphony SP/AS must only be performed by QIAGEN Field Service Specialists.

WARNING/CAUTION **Risk of personal injury and material damage**
Improper use of the QIASymphony SP/AS may cause personal injuries or damage to the instrument.



CAUTION**Damage to the instrument**

Avoid spilling water or chemicals onto the QIASymphony SP/AS. Instrument damage caused by water or chemical spillage will void your warranty.

Perform the maintenance as described in Section 14. QIAGEN charges for repairs that are required due to incorrect maintenance.

Note: Do not place items on top of the QIASymphony SP/AS hoods.

CAUTION**Damage to the instrument**

Do not lean on the touchscreen when it is folded down.

Note: In case of emergency, switch off the QIASymphony SP/AS instruments and unplug the power cord from the power outlet.

2.2 Electrical safety

Note: If operation of the instruments is interrupted in any way (e.g., due to interruption of the power supply or a mechanical error), first switch off the QIASymphony SP/AS instruments, then disconnect the electrical cord from the power supply and contact QIAGEN Technical Services.

WARNING**Electrical hazard**

Any interruption of the protective conductor (earth/ground lead) inside or outside the instrument or disconnection of the protective conductor terminal is likely to make the instrument dangerous. Intentional interruption is prohibited.

Lethal voltages inside the instrument

When the instrument is connected to line power, terminals may be live. Opening covers or removing parts is likely to expose live parts

When working with the QIASymphony SP/AS instruments:

- The line power cord must be connected to a line power outlet that has a protective conductor (earth/ground).
- Do not adjust or replace internal parts of the instruments.
- Do not operate the instruments with any covers or parts removed.
- If liquid has spilled inside the instruments, switch off the instruments, disconnect them from the power outlet, and contact QIAGEN Technical Services.
- The instrument shall be installed in a way that the power cord is accessible.

If the QIAAsymphony SP/AS instruments become electrically unsafe, prevent other personnel from operating them, and contact QIAGEN Technical Services.

The instruments may be electrically unsafe when:

- The QIAAsymphony SP/AS or the line power cord appears to be damaged.
- The QIAAsymphony SP/AS has been stored under unfavorable conditions for a prolonged period.
- The QIAAsymphony SP/AS has been subjected to severe transport stresses.
- Liquids have come into direct contact with electrical components of the QIAAsymphony SP/AS.
- The power cord has been exchanged with a non-official power cord.

2.3 Environment

2.3.1 Operating conditions

WARNING Explosive atmosphere



The QIAAsymphony SP/AS is not designed for use in an explosive atmosphere.

WARNING Risk of overheating



To ensure proper ventilation, maintain a minimum clearance of 5 cm (1.97 in.) at the rear of the QIAAsymphony SP/AS.

Slits and openings that ensure the ventilation of the QIAAsymphony SP/AS must not be covered.

2.4 Waste disposal

Used consumables, such as sample tubes, sample prep cartridges, 8-Rod Covers, disposable filter-tips, reagent tubes, and elution racks, may contain hazardous chemicals or infectious agents from the purification or assay setup process. Such wastes must be collected and disposed of properly according to local safety regulations.

CAUTION Hazardous materials and infectious agents



The waste contains samples and reagents. This waste may contain toxic or infectious material and must be disposed of properly. Refer to your local safety regulations for proper disposal procedures.

For disposal of waste electrical and electronic equipment (WEEE), see Appendix, page 207.

2.5 Biological safety

Note: Specimens and reagents containing materials from humans should be treated as potentially infectious. Use safe laboratory procedures as outlined in publications such as Biosafety in Microbiological and Biomedical Laboratories, HHS (www.cdc.gov/biosafety.htm).

2.5.1 Samples

WARNING **Samples containing infectious agents**



Some samples used with this instrument may contain infectious agents. Handle such samples with the greatest of care and in accordance with the required safety regulations.

Always wear safety glasses, gloves, and a lab coat.

The responsible persons (e.g., laboratory manager) must take the necessary precautions to ensure that the surrounding workplace is safe, and that the instrument operators are suitably trained and not exposed to hazardous levels of infectious agents as defined in the applicable Safety Data Sheets (SDSs) or OSHA,* ACGIH† or COSHH‡ documents.

Venting for fumes and disposal of wastes must be in accordance with all national, state, and local health and safety regulations and laws.

* OSHA: Occupational Safety and Health Administration (United States of America).

† ACGIH: American Conference of Government Industrial Hygienists (United States of America).

‡ COSHH: Control of Substances Hazardous to Health (United Kingdom).

Note: Samples may contain infectious agents. You should be aware of the health hazard presented by such agents and should use, store, and dispose of such samples in accordance with the required safety regulations.

2.6 Chemicals

WARNING **Hazardous chemicals**



Some chemicals used with the QIASymphony SP/AS instruments may be hazardous or may become hazardous after completion of the protocol run.

Always wear safety glasses, gloves, and a lab coat.

The responsible persons (e.g., laboratory manager) must take the necessary precautions to ensure that the surrounding workplace is safe and that the instrument operators are not exposed to hazardous levels of toxic substances (chemical or biological) as defined in the applicable Safety Data Sheets (SDSs) or OSHA,§ ACGIH¶ or COSHH** documents.

Venting for fumes and disposal of wastes must be in accordance with all national, state, and local health and safety regulations and laws.

§ OSHA: Occupational Safety and Health Administration (United States of America).

¶ ACGIH: American Conference of Government Industrial Hygienists (United States of America).

** COSHH: Control of Substances Hazardous to Health (United Kingdom).

2.6.1 Toxic fumes

Note: If you work with volatile solvents, toxic substances, etc., you must provide an efficient laboratory ventilation system to remove vapors that may be produced.

WARNING Toxic fumes



Do not use bleach to clean or disinfect QIA Symphony SP/AS instruments. Bleach in contact with salts from the buffers can produce toxic fumes.

WARNING Toxic fumes



Do not use bleach to disinfect used labware. Bleach in contact with salts from the buffers used can produce toxic fumes.

2.7 Mechanical hazards

The hoods of the QIA Symphony SP/AS instruments must remain closed during operation. Only open the hoods when instructed to do so by the software.

WARNING Moving parts



To avoid contact with moving parts during operation of QIA Symphony SP/AS instruments, the instruments must be operated with the hoods closed. If the hood sensors are not functioning correctly, contact QIAGEN Technical Services.

WARNING Strong magnetic field



Do not place QIA Symphony SP/AS instruments near magnetic storage systems (e.g., computer discs).

Do not use metal tools when handling the magnetic rods.

Do not allow the magnetic rods to come into contact with other magnets.

CAUTION Damage to the instrument(s)



Make sure to install the magnetic-head guards before operating the QIA Symphony SP.

2.8 Heat hazard

The QIASymphony SP supports a lysis station that can be heated, if required by the protocol. In addition, both the QIASymphony SP and the QIASymphony AS support a UV lamp.

WARNING **Hot surface**



The lysis station and the UV lamps can reach temperatures of up to 90°C (194°F). Avoid touching them during operation.

2.9 Maintenance safety

WARNING/ **Risk of personal injury and material damage**
CAUTION



Only perform maintenance as described in this consolidated operating guide.

Perform the maintenance as described in Section 14. QIAGEN charges for repairs that are required due to incorrect maintenance.

WARNING/ **Risk of personal injury and material damage**
CAUTION



Improper use of QIASymphony SP/AS instruments may cause personal injuries or damage to the instruments.

QIASymphony SP/AS instruments must only be operated by qualified personnel who have been appropriately trained.

Servicing of QIASymphony SP/AS instruments must only be performed by QIAGEN Field Service Specialists.

WARNING **Risk of fire**



When cleaning QIASymphony SP/AS instruments with alcohol-based disinfectant, leave the instrument hoods open to allow flammable vapors to disperse.

Only clean QIASymphony SP/AS instruments with alcohol-based disinfectant when worktable components have cooled down.

CAUTION **Damage to the instrument(s)**



Do not use bleach, solvents, or reagents containing acids, alkalis, or abrasives to clean QIASymphony SP/AS instruments.

CAUTION**Damage to the instrument(s)**

Do not use spray bottles containing alcohol or disinfectant to clean surfaces of the QIASymphony SP/AS instruments. Spray bottles should be used only to clean items that have been removed from the worktables.

CAUTION**Damage to the instrument hood(s) or side panels**

Never clean the instrument hood(s) or side panels with alcohol or alcohol-based solutions. Alcohol will damage the hood and the side panels. To clean the hood(s) and side panels, use distilled water.

CAUTION**Damage to the instrument(s)**

After wiping the drawers, the perforated metal plate and lysis station with paper towels, make sure that no bits of paper towel remain. Pieces of paper towel remaining on the worktable could lead to a worktable collision.

**WARNING/
CAUTION****Risk of personal electric shock**

Do not open any panels on the QIASymphony SP/AS instruments.

Only perform maintenance as described in this consolidated operating guide.

CAUTION**Damage to the instrument(s)**

Make sure to install the tip guards correctly before operating QIASymphony SP/AS instruments.

CAUTION**Damage to the instrument(s)**

Make sure to install the magnetic-head guards before operating the QIASymphony SP.

2.10 Radiation safety

WARNING Risk of personal injury



Do not expose your skin to UV-C light (254 nm) from the UV lamp.

WARNING Risk of personal injury













Hazard Level 2 laser light: Do not stare into the light beam.

2.11 Symbols on the QIASymphony SP/AS instruments

The following symbols appear on both the QIASymphony SP and QIASymphony AS instruments, except the heat hazard symbol, which appears only on the QIASymphony SP.

Symbol	Location	Description
	Lysis station	Heat hazard — the temperature of the lysis station can reach up to 90°C (194°F).
	QIASymphony SP — on front of waste drawer* and tip disposal bag/cabinet panel* QIASymphony AS — on the worktable, near the magnetic lock of the hood†	Biohazard — the tip rack slots, waste, and the worktable may be contaminated with biohazardous material and must be handled with gloves.
	Robotic arm — operator facing panel‡ Adjacent to the crushing hazard	Turn off the UV lamp before opening the lid or for servicing. During the decontamination, the housing must remain closed. Avoid looking directly into UV light. Do not expose your skin to UV light.
	Robotic arm — operator facing panel‡	Moving parts — make sure to keep the hood and drawers closed during operation.

Symbol	Location	Description
	Next to the type plate on the back of the instrument	Laser radiation — do not stare into beam.
	Position 1: Robotic arm — behind the sample input lid ^g	Hazard Level 2 laser light — do not stare into beam. Bar code scanner (BCL8) Laser Class 2 (655 nm)
	Position 2: Robotic Arm — operator facing panel ^h	Hazard Level 2 laser light — do not stare into beam. Laser displacement sensor (OADM13) Laser Class 2 (650 nm)
	Type plate on the back of the instrument	CE mark for Europe.
	Type plate on the back of the instrument	CSA listing mark for Canada and the USA.
	Type plate on the back of the instrument	FCC mark of the United States Federal Communications Commission.
	Type plate on the back of the instrument	RCM (former C-Tick) for Australia.
	Type plate on the back of the instrument	RoHS mark for China (the restriction of the use of certain hazardous substances in electrical and electronic equipment).
	Type plate on the back of the instrument	WEEE mark for Europe.

Symbol	Location	Description
	Type plate on the back of the instrument	Legal manufacturer.
	On the worktable	Consult instructions for use.

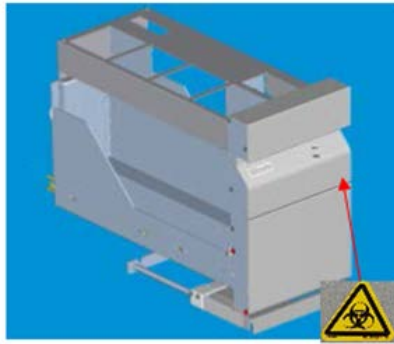
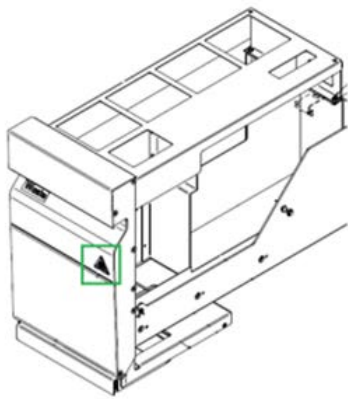

* Position of the biohazard warning label on the front panel of the “Waste” drawer (SP).



* Position of the biohazard warning label on the cabinet panel (SP).

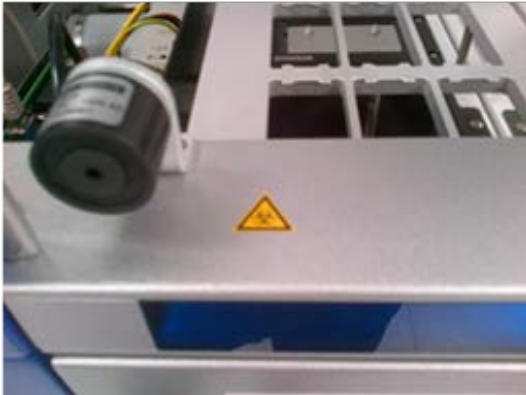

† Position of the biohazard warning label on the worktable, near the magnetic lock of the hood (AS).



‡ Position of the crushing hazard warning label and UV light warning label (SP/AS).



§ Position 1 for laser light warning label.

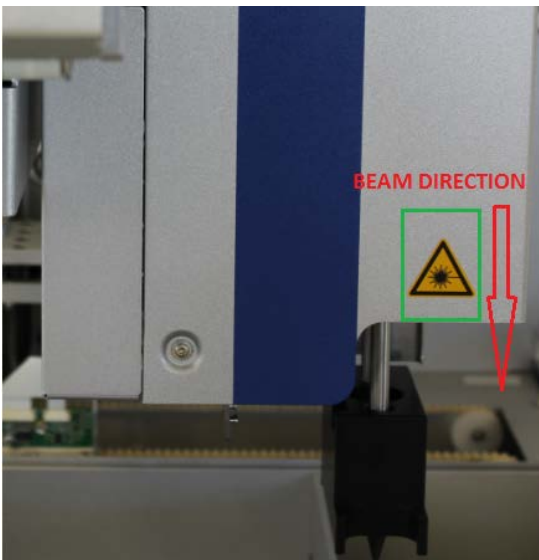

¶ Position 2 for laser light warning label (SP).



¶ Position 2 for laser light warning label (AS).

3 Startup Procedure

The unpacking and installation of QIASymphony SP/AS instruments is carried out by a certified QIAGEN Field Service Specialist. A member of your group who is familiar with laboratory and computer equipment should be present during the installation.

See “Packing List QIASymphony SP” and “Packing List QIASymphony AS” for a full list of components that are supplied with each instrument.

3.1 Site requirements

The QIASymphony SP/AS must be located out of direct sunlight, away from heat sources, and away from sources of vibration and electrical interference. The site of installation should be free of excessive drafts, excessive moisture, excessive dust, and not subject to large temperature fluctuations.

WARNING Risk of overheating



To ensure proper ventilation, maintain a minimum clearance of 5 cm (1.97 in.) at the rear of the QIASymphony SP/AS.

Slits and openings that ensure the ventilation of the QIASymphony SP/AS must not be covered.

3.1.1 Workbench

We recommend positioning QIASymphony SP/AS instruments on the QIASymphony Cabinet SP/AS, which is not included in the equipment supplied.

If you position QIASymphony SP/AS instruments on an alternative workbench, ensure that it is large enough and strong enough to accommodate the instruments. Ensure that the workbench is dry, clean, vibration proof, and has additional space for accessories.

Note: It is extremely important that QIASymphony SP/AS instruments are placed on a stable surface.

See Section 1.5 for the weight and dimensions of QIASymphony SP/AS instruments.

For further information about required specifications of the workbench, contact QIAGEN Technical Services.

3.2 General features

3.2.1 Hood(s)

The instrument hood(s) protects users from the moving robotic arm and from potentially infectious material on the worktable. The hood(s) can be manually opened to gain access to the worktable (e.g., for cleaning). During operation of the QIAAsymphony SP and/or the QIAAsymphony AS, the hood(s) must remain closed and should only be opened when instructed to do so by the software.

The hood(s) is locked:

- During sample preparation on the QIAAsymphony SP
- During an assay run on the QIAAsymphony AS

If force is used to open the hoods during a run, the run will be paused.

Note: If the hoods are opened during a run, the instruments will not immediately stop. The instruments will stop when processing of the current protocol step is finished. In some cases, this may take some time.

3.2.2 Touchscreen

The QIAAsymphony SP/AS is controlled using a swivel-mounted touchscreen. The touchscreen allows the user to, for example, select and run protocols, and upload/download files (e.g., Assay Control Sets) from/to a USB stick.

3.2.3 USB ports

The USB ports at the front left and front right of the QIAAsymphony SP allow connections of the QIAAsymphony SP/AS to a USB stick and a handheld bar code scanner (supplied with the QIAAsymphony SP). New protocols, Assay Control Sets, new labware files (e.g., files enabling new types of tubes to be used with the QIAAsymphony SP), and work lists can be uploaded to the QIAAsymphony SP via the USB port. Data files, such as system log files, report files, loading information files, and rack files can also be transferred via the USB port from the QIAAsymphony SP to the USB stick.

Note: Do not remove the USB stick while downloading or uploading files.

3.2.4 Network interface

The network interface allows connections of the QIAasymphony SP/AS instruments to a network via a CAT5 Ethernet network cable.

3.2.5 Status LEDs

Light-emitting diodes (LEDs) at the front of QIAasymphony SP/AS instruments are illuminated when sample preparation or assay setup is in progress. The status LEDs flash when a batch/run is finished or if an error occurs. Touching the screen turns off the flashing.

3.3 Switching on the QIAasymphony SP/AS

3.3.1 Getting started



Preparing the QIAasymphony SP/AS before startup

Note: An empty unit box must be placed into slot 4 of the “Reagents and Consumables” drawer because, during initialization, the handler goes down into the unit box in position 4. If the unit box is not empty, the handler will crash.

1. Make sure that the liquid waste bottle, tip disposal bags and waste containers are empty.
2. Make sure that all drawers and both hoods are closed. If the hood(s) is opened during instrument startup, the system test will fail.

After successful startup, QIAasymphony SP/AS instruments are ready for use. The **Integrated Run** screen will be displayed.

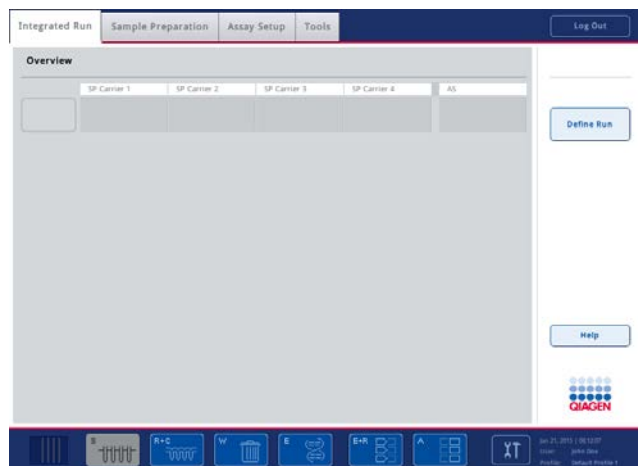

Note: Before using the QIAasymphony SP/AS, the user must log in. For information about user accounts, see Section 4.2.

3.3.2 Logging out

After pressing the **Run** button, you have the option to log out. The run will continue.

Active logout



To log out, press **Log Out** at the top of the **Sample Preparation** or **Assay Setup** screen.



If you are logged out, the status bar only displays the date and time.

Automatic logout

After a defined period of user inactivity, the user currently logged in is automatically logged out. The default setting for this period of user inactivity is 15 minutes. Ask the "Supervisor" to adjust the time period to suit your needs or to switch it off, if required.

3.3.3 Switching off the QIAasymphony SP/AS

To switch off the QIAasymphony SP/AS instruments, press the power switch at the front of the QIAasymphony SP in the lower left corner. We recommend switching off the instruments after use.

Note: Do not switch off the instruments during sample preparation or assay setup unless you need to stop the instruments due to an emergency. You will not be able to resume the protocol or assay run and the samples cannot be processed further by the QIAasymphony SP/AS.

Note: The QIAasymphony SP/AS instruments will lose all inventory information when the instruments are switched off.

Note: After the QIAasymphony SP/AS instruments are switched off, the power switch flashes a few times. When the power switch stops flashing it is safe to switch the QIAasymphony SP/AS instruments on again.

4 User Settings

4.1 Configuration settings

Note: The “Supervisor” can configure the systems settings.

For more information, refer to Section 6, “Configuration”, of the *QIAsymphony SP/AS User Manual – General Description*.

4.2 User accounts

The QIAsymphony SP/AS recognizes 2 different user roles:

Supervisor The “Supervisor” role enables preparation and running of batches and assay runs. The “Supervisor” can configure the users, default tube types for the QIAsymphony SP, and adapters/holders for the QIAsymphony AS. The “Supervisor” can also configure the system and define custom configuration profiles. In addition, the “Supervisor” can:

- Transfer input and output files, process files, and most instrument setup files from QIAsymphony SP/AS instruments to the USB stick.
- Transfer rack files, work list files, process files, and most instrument setup files from the USB stick to the QIAsymphony SP/AS instruments.
- Manage the user account for other users; they can also adjust the configuration settings.

Operator The “Operator” role enables preparation and running of batches and assay runs. In addition, the “Operator” can:

- Transfer input and output files from QIAsymphony SP/AS instruments to a USB stick.
- Transfer rack files and work lists from a USB stick to the QIAsymphony SP/AS instruments.

Before operating the QIAsymphony SP/AS, the user accounts must be defined.

If no user is logged in, all drawers are locked.

4.2.1 Create new users

The “Supervisor” must use the following default password the first time they log in: **ive2ad**.

To create new users or to reset user passwords, follow the steps below.



1. Log in as “Supervisor”.
The **Please select user:** screen will open.

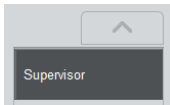

2. Select the “Supervisor” button.
The **Please enter password** screen will open.
3. Enter the password in the blue field and confirm with **OK**.

Note: If you are logging in as “Supervisor” for the first time, you must change the default supervisor password. To do this, follow the instructions in the touchscreen.

The **Sample Preparation** screen will be displayed again.



The “Supervisor” user ID is now visible in the status bar on the lower right.



4. Press the **Tools** tab.
The **Tools** menu will be displayed.



5. Press the **User Management** button.
The **User Management/Please Select User** screen appears.



6. Press the **Add User** button.
The **Create User** screen appears.



7. Enter new user settings in the blue fields and confirm with **Next**.
The **Assign Roles** screen appears.

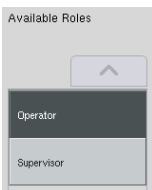

8. Select the role of the user account to be created.
The selected role will be highlighted inverse.

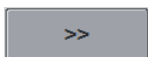

9. Press the arrow button to assign the selected role to the newly created user account.
The new user will be added to **User Roles**.

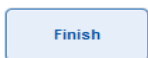





10. Press **Finish**. The login information of the newly created user account will be saved.

4.2.2 Activate/inactivate user accounts

User accounts cannot be deleted. The user with the “Supervisor” user ID must deactivate the user account so that it is no longer displayed in the **Activated Users** list.

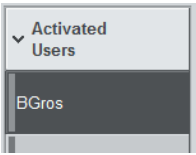
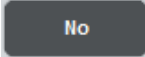
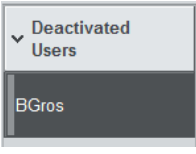
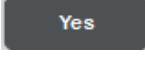
To inactivate/activate a user account, follow the steps below.

- 
1. Log in as “Supervisor”.
See steps 1–3 of Section 4.2.1 for more information.
- 
2. Press the **Tools** tab.
The **Tools** menu will be displayed.
- 
3. Press the **User Management** button.
The **User Management/Please Select User** (“Supervisor login”) screen appears.
- 
4. **Deactivation:** Select the user name from the list in the **Activated Users** package and press the **No** button.
The selected user will be removed from the list and transferred to the **Deactivated Users** list.
- 
5. **Activation:** Select the user name from the list in the **Deactivated Users** package and press the **Yes** button.
The selected user will be removed from the list and transferred to the **Activated Users** list.
- 
- 
6. Press **Save** to confirm the changes.
- 

4.2.3 System request for password change

You may be prompted by the instrument software to enter a new password. This may happen the first time you log in, after the “Supervisor” resets your password, if the “Supervisor” switches from

the standard password policy to a (restrictive) stronger password policy (go to the **Tools** menu, **Configuration** in **System 1** tab), or if your password has expired.

Note: The password must be a minimum of 8 characters. It should not be same as the login name and it must differ from the previous 10 passwords.

If the strong password policy is enabled, the password must be a minimum of 8 characters — 2 upper case, 2 lower case, 2 numeric and 2 special characters. It should not be same as the Login name and it must differ from the previous 10 passwords.

Note: Passwords expire after 60 days by default.

This setting can be changed by the “Supervisor” in the **Configuration** menu in the **System 1** tab. It is also possible to deactivate the password expiration setting.

If a password has expired, you will be prompted to enter a new password after logging in.

To change your password, follow the steps below.

New Password:



1. Press **New Password** text field.

The **Keyboard** screen appears.

2. Enter a new password and press **OK**.

The **Confirm New Password/Please enter new password again** screen appears.

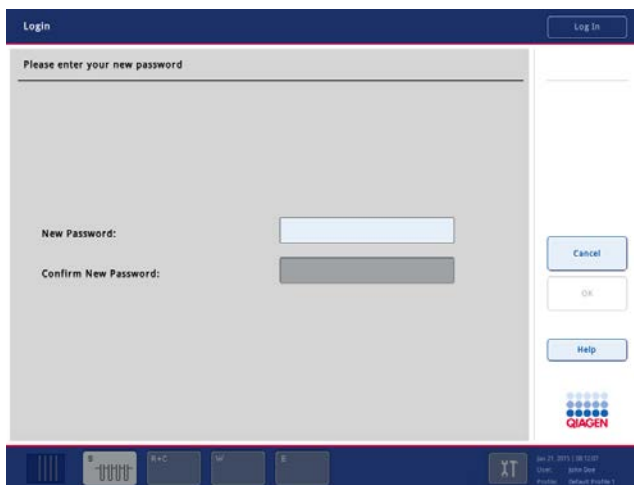

Confirm New Password:

3. Press **Confirm New Password** text field.

The **Keyboard** screen appears again.

4. Enter the new password again to confirm it.



5. Press **OK**.

The **Login/Please enter your new password** screen will appear again.

4.2.4 User request for password change

It is also possible to change your password independently of the password expiration.



1. Press **Log In** and select your user name from the list.

The **Keyboard** screen appears.



2. Enter your password and confirm with **OK**.

The **Sample Preparation** screen appears.



3. Press the **Tool** tab and select **User Management**.

The **User Management/Your user data** screen appears.



4. Press **Change PWD**.

The **User Management/Please enter your new password** screen appears.

Old Password:

5. Press **Old Password** text field.



6. Enter the old password in the **Keyboard** screen and press **OK**.

The **User Management/Please enter your new password** screen appears again.

New Password:

7. Press **New Password** text field.



8. Enter a new password in the **Keyboard** screen and press **OK**.

The **User Management/Please enter your new password** screen appears again.

Confirm New Password:

9. Press **Confirm New Password** text field.



10. Confirm the new password and press **OK**.

The new password is now active.

4.3 Language package installation

Only the “Supervisor” role has the ability to upload the language package provided by QIAGEN. The language package can be installed on QIASymphony SP/AS using the USB stick or the QIAGEN Management Console (QMC).

4.3.1 Setting up the USB stick and transferring language files from the USB stick

Add the **/data/translation** folder to the USB stick and copy the language package ***.tar.gz** file (e.g., **QIASymphony_SingleLanguagePackage_English-5.0.3.34_Release.tar.gz**) into the folder.

1. Plug the USB stick with the language package into the USB port of the instrument.
2. Login with “Supervisor” role.
3. Press **Tools**.
4. Press **File Transfer**.
5. Press the **Instr. Setup Files** tab.

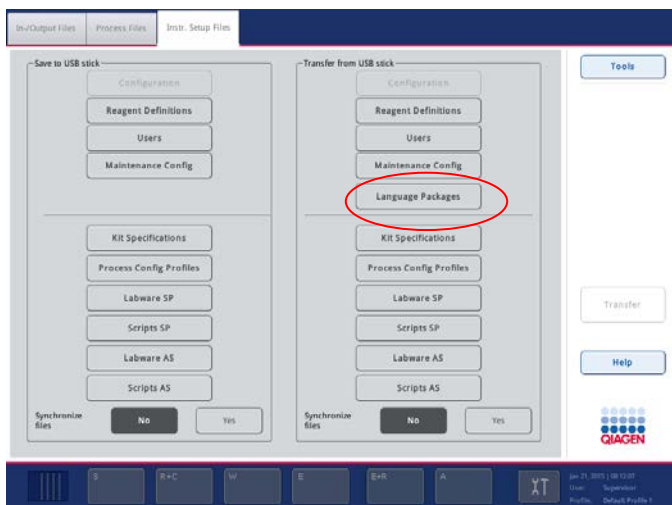

6. Press **Language Packages**.
7. Press **Transfer**.

Note: When selecting **Language Packages**, **Synchronize files** is not possible (**No** is the default selection).

4.3.2 Transferring files using the QMC

Each “Translation” file represents a language package for one language.

“Translation” files can be transferred by the “Supervisor” role to the QIAsymphony SP/AS using the file transfer tool of the QIAsymphony Management Console (QMC) and are visible in the respective selections. “Translation” file(s) have to be located in the **root\data\translation** folder.

4.3.3 Changing the language on QIAsymphony SP/AS

After the language package upload is complete, the “Supervisor” can configure the language of the user interface. The language change will take effect after the system is rebooted.

To change the language, proceed as follows:

1. Log in with the “Supervisor” role.
2. Press the **Tools** tab.
3. Press the **Configuration** button. The **Configuration** menu appears.
4. Select the **Time/Language** tab.

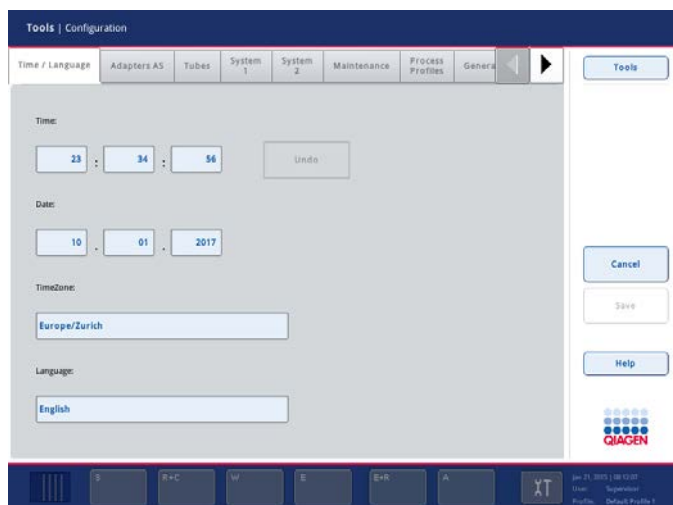

5. Select the **Language** field.
6. Select an available language from the **Language** list.
7. Press the **Save + Reboot** button to save the changes.

The QIAsymphony SP/AS will restart.

4.3.4 Changing the language in QIAsymphony Management Console (QMC)

To change the QMC language, complete the steps below.

Note: In Windows®, the QMC has to be in the “Run as Administrator” mode. To enter this mode, right-click on **<QMC Installation Directory>\bin\ qQMCApplication.exe** and then select **Run as Administrator**.

1. Select **Tools**.
2. Select **Options**. The **Options** dialog box is displayed.
3. Select the **General** tab. The corresponding parameters appear.

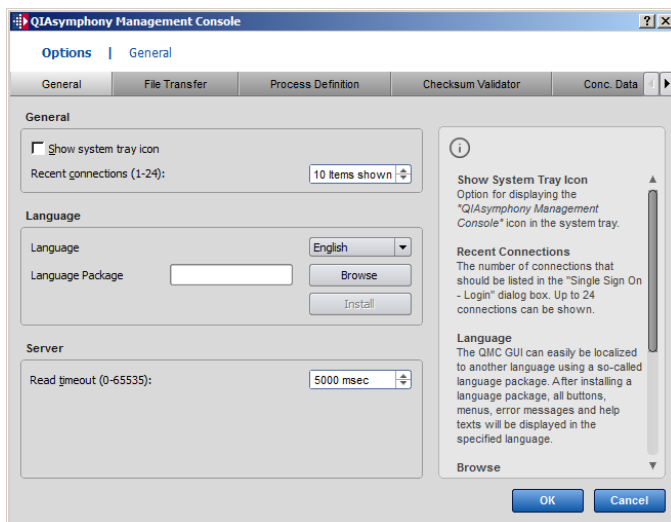

4. Click **Browse**.
5. Navigate to the location of the downloaded language pack.
6. Select the zipped language pack file.
7. Click **Open**.
8. Click **Install**.
9. Select the language.
10. Click **OK**.
11. Close (**File**→**Exit**) and restart the QMC.

5 QIASymphony SP/AS User Interface

5.1 QIASymphony SP/AS screen layout

This section gives a quick introduction of the user interface of QIASymphony SP/AS software menus. Descriptions of the tabs, tools, and buttons are listed in separate tables.

For more detailed information, see Section 16.

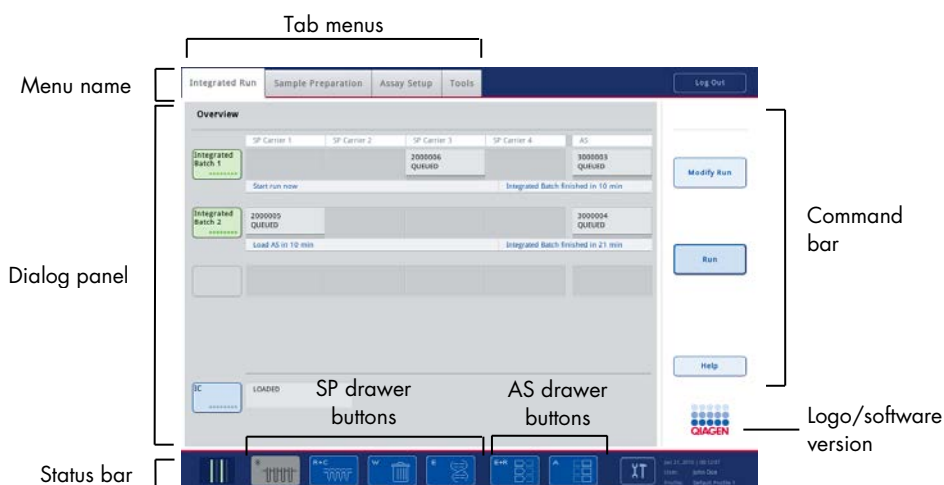

5.1.1 Status bar

Batch status icon

The batch status icon provides the user with information about each sample batch.



The color of each tube carrier denotes the status of the associated batch.

The way the batch status icon is displayed varies according to whether samples are loaded in a tube on the QIASymphony SP.

Drawer buttons

If a QIASymphony AS module is installed, a button for each QIASymphony AS drawer appears in the status bar of the common SP/AS user interface adjacent to the QIASymphony SP drawer buttons.



Press the “S” button to open the **Sample Preparation/Define Sample Rack Type** screen.

If the “S” button is flashing, press the button so that the warning or error message can be displayed.

The button for the **Sample** drawer is active if the **Batch Overview** or **Sample View** screen of the **Sample Preparation** menu is displayed.



Press the “R+C” button to open the **Consumables/Cartridges/Filter-Tips** screen. When using the QIASymphony SP/AS, the screen is called **Consumables/Cartridges/Filter-Tips**.

The button is active if the **Consumables/Cartridges/Filter-Tips** screen is displayed. This screen appears when the “R+C” button is pressed.

If insufficient consumables and reagents are loaded for the queued batches, the “R+C” button becomes yellow and flashes. After opening the **Consumables/Cartridges/Filter-Tips** screen, the “R+C” button becomes gray again.



Press the “W” button to open the **Waste** screen.

The button for the **Waste** drawer is active when the **Waste** screen is displayed. This screen appears after the “W” button has been pressed.

If there is insufficient space in the **Waste** drawer for used 8-Rod Covers or sample prep cartridges, the “W” button becomes yellow and flashes. After opening the **Waste** screen, the button becomes gray again.



Press the “E” button to open the **Elution Slot/Configure Racks** screen.

The button for the **Eluate** drawer is active if either the **Sample Preparation/Elution Slot/Configure Racks** or the **Sample Preparation/Elution Slot** screen is displayed. One of these screens appears when the “E” button is pressed or if the **Eluate** drawer is opened.

Note: The “E” button becomes green and the arrow symbols flash if an elution rack is ready to be removed from the **Eluate** drawer.



When an assay run has been defined, press the “E+R” button to open the **Loading Information** screen.

This button flashes yellow if there are insufficient adapters or rack positions available for the defined runs. In this situation, if you press the button, a message appears informing the user why it is not possible to start the run.



When an assay run has finished, the “A” button flashes green. In this situation, if you press the button, a message appears informing the user that the run has been completed. Press **OK** to confirm the message.

If there are insufficient assay racks available for the selected assays, this button flashes yellow. In this situation, if you press the button, a message appears informing the user why it is not possible to start the run.

5.1.2 Tab menus

Integrated Run

The **Integrated Run** tab is used to:

- Define integrated runs
- View information about the status of defined integrated runs (i.e., progress, batch status, estimated time remaining, and the next user interaction required for each integrated batch)

Sample Preparation

The **Sample Preparation** tab is used for running protocols, to control the individual drawers, for logging in to the instrument, and for the Wizard.

Assay Setup

The **Assay Setup** tab is used to define independent runs on the QIASymphony AS. In this tab, the user can:

- Assign Assay Parameter Sets
- View information about the QIASymphony AS (including the progress and status of assay setup)
- Remove completed assays

Tools

The **Tools** tab provides access to several menus required for operation of QIASymphony SP/AS instruments.

Note: A protocol is a set of instructions that allows the QIASymphony SP to perform a molecular biology application. The handbook supplied with your QIASymphony kit will tell you which protocol you should use.

5.2 Software symbols

During operation of QIAsymphony SP/AS instruments, messages may appear that provide the user with general information, inform the user that operator input is required, or provide information about warnings and errors. Each type of message contains a symbol for easy identification by the user.



This symbol is displayed if the message contains information about an error.



This symbol is displayed in warning messages.



This symbol is displayed if input by the user is required.



This symbol is displayed if the message provides the user with information.

6 Handling Files

This section describes how users with the “Operator” user ID can upload and download files.

For detailed information about file handling, refer to Section 8, “Handling Files”, of the *QIASymphony SP/AS User Manual – General Description*.

6.1 Transfer options

When you are logged in as “Operator” you will be able to transfer the following file types:

From QIASymphony SP/AS instruments to USB stick (downloading)

- Log files
- Result files
- Confirmation files
- Loading information
- Cyclor Files
- Instrument Reports
- Audit Trail Files
- QDef Files
- Rack files
- Work lists

From USB stick to QIASymphony SP/AS instruments (uploading)

- Concentration File
- Rack files
- Work lists

Synchronization of file types between QIASymphony SP/AS and USB stick

- Rack files
- Work lists

Files can be handled directly using a USB stick or, alternatively, using the **File Transfer** tool in the QIASymphony Management Console. Result files, work list files, loading information files, cyclor files, and log files can also be handled using the **Automatic File Transfer** tool.

For more information about both tools, refer to the *QIASymphony Management Console User Manual*. If the **Automatic File Transfer** tool is used, the user with the “Supervisor” user ID must assign

a password to the **File Transfer** user. Refer to the *QIASymphony Management Console User Manual* for information about how to do this.

For detailed information about QIASymphony SP/AS file types, refer to Section 8.1 of the *QIASymphony SP/AS User Manual – General Description*.

6.2 Data transfer via the USB stick

Note: If you are using the QIASymphony Management Console to synchronize your data, the file/folder structure of the USB stick is set up automatically. The file/folder structure is displayed in Section 8.3.1 of the *QIASymphony SP/AS User Manual – General Description*.

Note: The QIAGEN USB stick should only be used for QIASymphony SP/AS data transfer. Make sure that the file/folder structure of the USB stick is correct and that enough storage space is available.

Note: Do not remove the USB stick during data transfer.

6.3 File transfer from QIASymphony instruments to the USB stick

To store data generated by QIASymphony SP/AS instruments, you can transfer files to the USB stick if the QIASymphony Management Console is not available.

If the QIASymphony SP/AS instruments are not connected to the network, this function can also be used to supply the **Process Definition** editor tool of the QIASymphony Management Console with the data required to create new Assay Control Sets and Assay Parameter Sets.

If you are using the QIASymphony Management Console, refer to the *QIASymphony Management Console User Manual* for more information.

To transfer files from QIASymphony SP/AS instruments to the USB stick, follow the steps below.

1. Log in to the QIASymphony SP/AS instruments.
2. Insert the USB stick into one of the USB ports at the front of the QIASymphony SP.
3. Press **File Transfer** in the **Tools** screen. The **In-/Output Files** tab of the **File Transfer** menu opens.

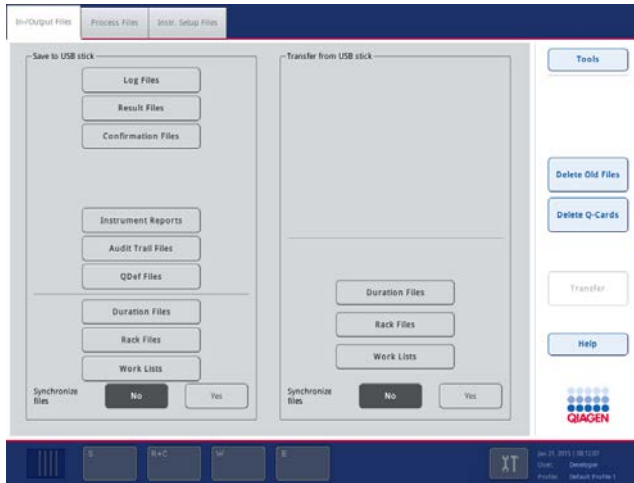

4. Select one of the file transfer tabs (**In-/Output Files**, **Process Files**, **Instr. Setup Files**).

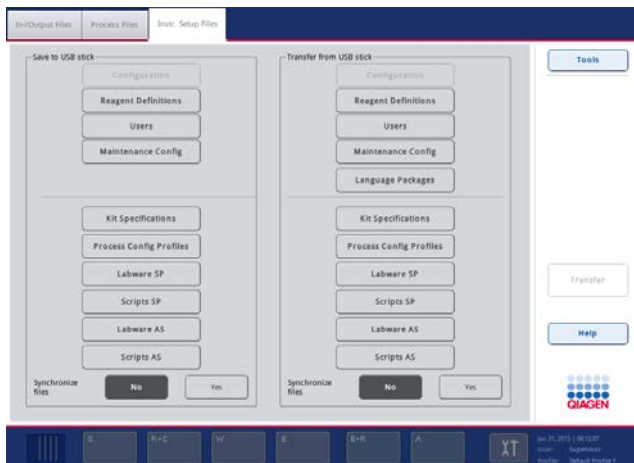
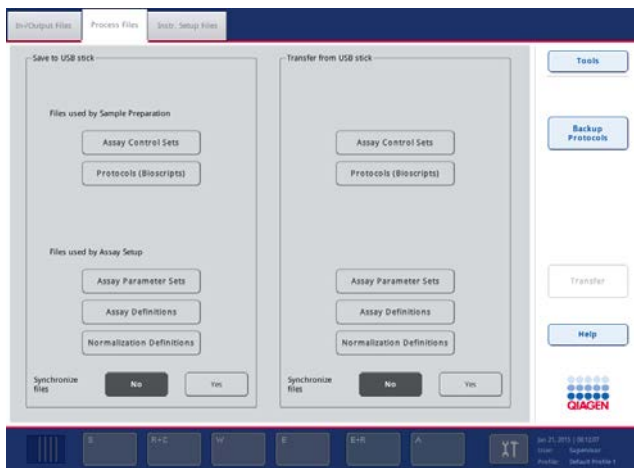

5. Select the file type(s) to be downloaded to the USB stick by pressing the appropriate button in the **Save to USB stick** panel.
6. Press the **Transfer** button in the command bar of the screen to transfer the selected files to the USB stick.

A message appears informing you that the files will be transferred from the QIAsymphony SP/AS instruments to the USB stick.
7. Press **Yes** to confirm that the files should be transferred.

During data transfer, an information message will be displayed.

After successful data transfer, a message will appear confirming data transfer.
8. Remove the USB stick.

6.4 Transferring files from the USB stick

Note: File transfer of both QIAsymphony SP and QIAsymphony AS files is performed using the **File Transfer** menu.

You can transfer files from the QIAsymphony Management Console to QIAsymphony SP/AS instruments. Alternatively, if you are not connected to the network, you can transfer files using the USB stick.

To transfer files from the USB stick to QIAsymphony SP/AS instruments, follow the steps below.

1. Copy the files to be uploaded to the corresponding directory on the USB stick.
2. Log in to the QIAsymphony SP/AS instruments.
3. Insert the USB stick into one of the USB ports at the front of the QIAsymphony SP.
4. Press **File Transfer** in the **Tools** screen to enter the **In-/Output Files** tab.
5. Select one of the file transfer tabs (**In-/Output Files**, **Process Files**, **Instr. Setup Files**).
6. Select the file type(s) to be uploaded to the QIAsymphony SP/AS instruments by pressing the appropriate button(s) in the **Transfer from USB stick** panel.

When the first file type has been selected, the **Transfer** button becomes active.
7. Press the **Transfer** button to transfer all selected file types from the USB stick to the QIAsymphony SP/AS instruments.

A message appears informing you that the files will be transferred from the USB stick to the QIAsymphony SP/AS instruments.

8. Press **Yes** to confirm that the files should be transferred.
During data transfer, an information message will be displayed.
After successful data transfer, a message will appear confirming the data transfer.
9. Remove the USB stick.

Note: You can select more than one file type at once.

Note: Make sure that **Synchronize files** is set to **No**.

6.5 Synchronizing files

Files stored on QIAsymphony SP/AS instruments can be synchronized with files on the USB stick.

- If the file already exists on the QIAsymphony SP/AS it will be overwritten.
- Files that exist on QIAsymphony SP/AS instruments but do not exist on the USB stick are deleted from QIAsymphony SP/AS instruments.
- After synchronization, the content of files of the same type that are stored on QIAsymphony SP/AS instruments and the USB stick is identical.

6.5.1 Synchronizing files on instruments with files on the USB stick

To synchronize files on QIAsymphony SP/AS instruments with files on the USB stick, follow the steps below.

1. Log in to the QIAsymphony SP/AS instruments.
Prepare the USB stick with the files for synchronization. Store the files you want to upload to the QIAsymphony SP/AS instruments in their corresponding folders on the USB stick (e.g., a newly defined rack file in the folder **/data/Worklists/**).
2. Insert the USB stick into one of the USB ports at the front of the QIAsymphony SP.
3. Press **File Transfer** in the **Tools** screen to enter the **In-/Output Files** menu.
4. Select one of the file transfer tabs (**In-/Output Files**, **Process Files**, **Instr. Setup Files**).
For example, to synchronize work lists, select the **In-/Output Files** tab.
5. Select the file type(s) on the QIAsymphony SP/AS instruments that should be synchronized with the files on the USB stick by pressing the appropriate button(s) in the **Transfer from USB stick** panel.
6. Set **Synchronize files** to **Yes** by pressing the **Yes** button.
7. Press the **Transfer** button in the command bar of the screen to synchronize the selected files type(s).

A message appears informing you that the files will be synchronized. Check that the information is correct.

8. To continue with the synchronization, press **Yes**.

After successful synchronization, a message will appear confirming synchronization.

9. Press **OK** to continue.

10. Remove the USB stick.

6.5.2 Synchronizing files on the USB stick with files on instruments

Files on the USB stick can be synchronized with files on the QIAsymphony SP/AS.

This means that files stored on the QIAsymphony SP/AS are transferred to the USB stick.

- If the file already exists on the USB stick it will be overwritten by the file from the QIAsymphony SP/AS instruments.
- Files that exist on the USB stick but do not exist on the QIAsymphony SP/AS instruments are deleted from the USB stick.

To synchronize files on a USB stick with files on the QIAsymphony SP/AS, follow the steps below.

1. Log in to the instrument with the "Supervisor" user ID.
2. Prepare the USB stick for synchronization. Insert the USB stick into one of the USB ports at the front of the QIAsymphony SP.
3. Press **File Transfer** in the **Tools** screen to enter the **In-/Output Files** tab menu.
4. Select one of the file transfer tabs (**In-Output Files**, **Process Files**, **Instr. Setup Files**).
5. Select the file type(s) that should be synchronized by pressing the appropriate button(s) in the **Save to USB stick** panel.
6. Set **Synchronize files** to **Yes** by pressing the **Yes** button.
7. Press the **Transfer** button in the command bar of the screen to synchronize the selected files.

A message appears informing you that the files will be synchronized. Check that the information is correct.

8. To continue with the synchronization, press **Yes**.

After successful synchronization, a message will appear confirming synchronization.

9. Remove the USB stick.

6.6 Deleting files

Different tools can be used to delete files from QIAsymphony SP/AS instruments. We recommend using the **File Transfer** tool of the QIAsymphony Management Console.

If the QIAsymphony SP/AS is not connected to the network, there is a method for deleting all input and output files, except log files, and a method for deleting all other files.

For detailed information about deleting files, refer to Section 8.5 of the *QIAsymphony SP/AS User Manual – General Description*.

7 QIASymphony SP Features

The section describes how to operate the QIASymphony SP instrument, including how to load and unload the worktable.

The QIASymphony SP performs fully automated purification of nucleic acids using magnetic-particle technology. Samples can be processed in batches of up to 24 samples. The instrument controls integrated components including a lysis station, 4-channel pipetting system, robotic gripper, and an array of magnetic rods that are protected by rod covers. These rods can pick up or release magnetic particles in the wells of a sample prep cartridge, depending on whether the magnetic rods are inserted in the rod covers or not.

The QIASymphony SP is preinstalled with various protocols and corresponding Assay Control Sets for purification of RNA, genomic DNA, and viral and bacterial nucleic acids. The user loads reagents (in prefilled, sealed reagent cartridges) and consumables into the appropriate drawer, loads the samples, and selects a protocol using the touchscreen. The user then starts the protocol, which provides all necessary commands for sample lysis and purification. A fully automated inventory scan (either after closing the individual drawers or before the run starts) helps to ensure that the QIASymphony SP is correctly set up for the protocol.

7.1 Workflow principle

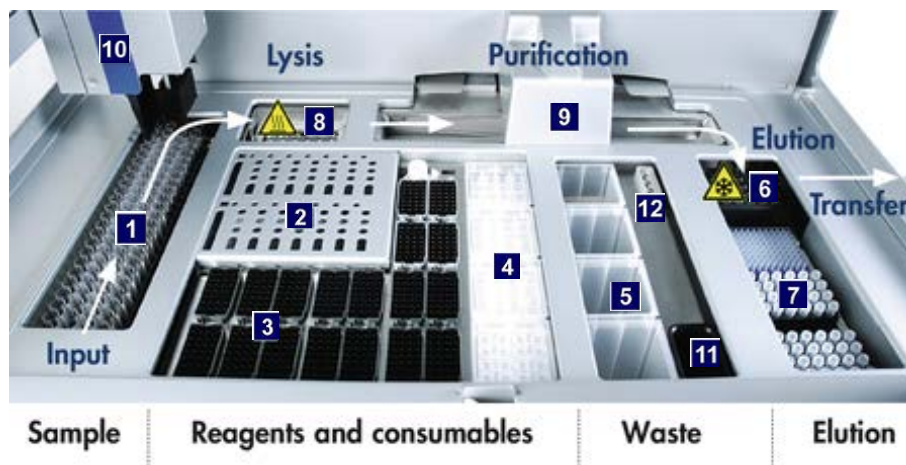

- | | | | | | |
|---|--------------------|---|---------------------------|----|------------------|
| 1 | Sample input | 5 | Waste compartment | 9 | Magnetic head |
| 2 | Reagent cartridges | 6 | "Elution slot 1" (cooled) | 10 | Robotic arm |
| 3 | Filter-tips | 7 | "Elution slots 2-4" | 11 | Tip waste chute |
| 4 | Consumables | 8 | Lysis station (heated) | 12 | Tip park station |

7.1.1 Basic principle

Sample preparation using the QIAAsymphony SP usually consists of 4 main steps: lyse, bind, wash and elute.

- Samples are lysed in the lysis station, which can be heated, if required by the protocol.
- Nucleic acids bind to the surface of the magnetic particles and are washed to remove contaminants.
- Purified nucleic acid is eluted.

The QIAAsymphony SP processes a sample containing magnetic particles as follows:

- A magnetic rod protected by a rod cover enters a well containing the sample and attracts the magnetic particles.
- Sample prep cartridges are positioned below the magnetic rod with its cover.
- The QIAAsymphony SP uses a magnetic head containing an array of 24 magnetic rods, and can therefore process 24 samples simultaneously. Steps 1 and 2 are repeated several times during sample processing.

7.2 Instrument features

7.2.1 Magnetic head

The magnetic head is comprised of an array of 24 magnetic rods for processing magnetic particles, a conveyor, and magnetic-head guards.

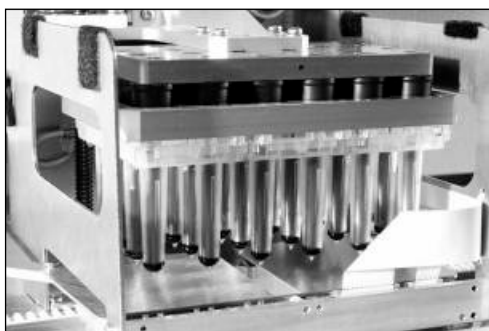

Magnetic head of the QIAAsymphony SP.

The magnetic head comprises a rod-cover drive for mixing samples and a magnetic-rod drive for separation and resuspension of magnetic particles. The conveyor moves the sample prep cartridges from the start position to the processing position and, finally, to the output position. The

magnetic-head guards move underneath the magnetic head and help to prevent contamination of the worktable or samples by any liquid that may drip from the rod covers.

Note: To prevent liquid from entering the QIASymphony SP, only operate the instrument with the magnetic-head guard installed.

7.2.2 Lysis station

The lysis station, a heated orbital shaker, enables automated lysis of up to 24 samples in 1 batch. After sample lysis, the lysis station moves upward so that samples can be transferred for further processing.



QIASymphony SP lysis station.

7.2.3 Robotic arm

The robotic arm provides accurate and precise positioning of the robotic gripper and pipettor head. The robotic arm also includes an optical sensor, a 2D bar code camera, and a UV lamp.

Robotic gripper

The robotic gripper transfers consumables (8-Rod Covers and sample prep cartridges) to the required position on the worktable during sample preparation.

Pipettor head

The pipettor head is mounted on the robotic arm and moves in the X, Y, and Z directions in order to reach different locations on the worktable.

The pipettor head contains 4 pipetting channels with high-precision syringe pumps that are connected to tip adapters. The tip adapters can be attached to disposable filter-tips. The syringe pumps can operate simultaneously to allow aspiration and dispensing of small volumes of liquid (20–1500 μ l, application- and liquid-dependent) via the attached disposable filter-tips.

Each pipetting channel can perform two types of liquid-level detection: capacitive-based liquid-level detection (cLLD) and pressure-based liquid-level detection (pLLD). To detect the liquid level, changes in capacitance or pressure between the disposable filter-tip and the liquid are measured.

Tip guards

Each pipettor head is equipped with 4 tip guards. During a run, the tip guards are positioned below the disposable tips to catch any drops of liquid that may fall. This helps to minimize the risk of cross-contamination.



Tip guards help to prevent cross-contamination.

Optical sensor

During an inventory scan, the optical sensor checks that the consumables are correctly loaded in the drawers and that there are sufficient consumables loaded for the run.

UV lamp

A UV lamp is mounted on the robotic arm and is used to decontaminate the worktable of the respective instrument. See Section 14.7 for information about operating the UV lamp.

7.3 Bar code reader

7.3.1 Sample input bar code reader

The QIA Symphony SP has an integrated bar code reader that can read bar codes on tube carriers and sample tubes. A default tube type must be defined for each type of insert used. The tube type is automatically assigned when the insert bar code is read.

Primary tubes can be labeled with bar codes.

The integrated bar code reader of the “Sample” drawer scans:

- The position bar codes of the tube carriers.
- The bar code labels on sample tubes.

Each slot in a tube carrier has a bar code at the back of the slot. If the position is empty, the bar code at the back of the slot can be read by the bar code reader. This enables the QIA Symphony SP to detect which positions in the tube carrier contain a tube and which are empty.

If you are using sample tubes that are not labeled with bar codes, tubes containing small volumes of liquid or clear liquids may not be detected. In this case, use a blank bar code label to enable detection of the sample tube. For more information, refer to the *QIA Symphony SP/AS User Manual – General Description*.

The scanned sample ID lists can be manually corrected and assigned into batches based on existing sample information or following user input. For more information, refer to the *QIA Symphony SP/AS User Manual – General Description*.

Four tube carriers are available for use with sample tubes. In some protocols, samples may also be processed with positive or negative controls. A fifth tube carrier accommodates tubes containing internal controls that will be added to the samples.

7.3.2 Reagents and consumables 2D bar code reader

As part of the inventory scan of the “Reagents and Consumables” drawer, the 2D bar code camera on the QIA Symphony SP identifies the different reagents in the reagent cartridge and also checks that the correct reagent cartridge has been loaded. The 2D bar code reader is attached to the robotic arm.

7.3.3 Bar code types

The handheld scanner and the **Sample Input** bar code reader can read bar codes of the following types:

- Code 39
- Code 128 and subtypes
- Codabar

Note: Do not use the bar code Interleaved 2 of 5. This bar code type has a high information density and no checksum. It can therefore generate errors.

For information about attaching 1D bar code labels to tubes, refer to Appendix A of the *QIASymphony SP/AS User Manual – General Description*.

7.3.4 Handheld scanner

The handheld scanner may be connected via USB connection to one of the USB ports of the QIASymphony SP/AS instruments. When using the QIASymphony Cabinet SP/AS, the handheld scanner is delivered with a magnetic holder. The magnetic holder can only be fixed to the metallic parts of the cabinet.



Handheld scanner.

Note: To enable easy use of the bar code scanner, we recommend positioning the magnetic holder on the middle metallic panel.

Note: For safe operation, hang the handheld scanner in its holder after use.

8 Loading QIASymphony SP Drawers

This section describes how to load and unload the worktable and how to perform inventory scans to operate the QIASymphony SP instrument.

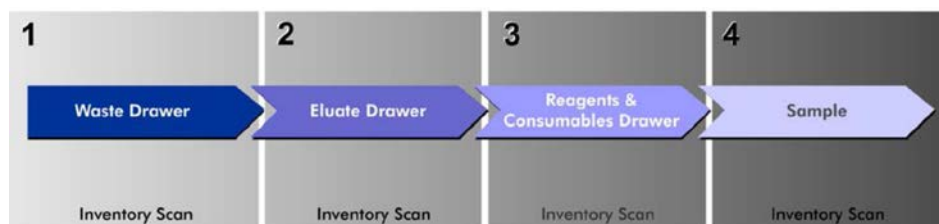

Workflow loading of QIASymphony drawers.

We recommend loading the drawers in the order:

1. "Waste" drawer
2. "Eluate" drawer
3. "Reagents and Consumables" drawer
4. "Sample" drawer

8.1 Using the software Wizard

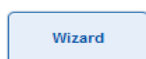

The QIASymphony SP operating software offers a **Wizard** that provides step-by-step guidance for setting up a run.

The **Wizard** takes you through:

- Loading the "Waste" drawer
- Loading the "Eluate" drawer
- Loading the "Reagents and Consumables" drawer
- Loading the "Sample" drawer
- Defining a batch/run with or without work lists
- Loading internal controls

It is possible to set up a run on the QIASymphony SP with or without the **Wizard**.

Note: The **Wizard** can only be used for setting up independent sample preparation runs. It cannot be used to set up an integrated run.

Note: Although the **Wizard** cannot be used with integrated runs, the steps for loading the QIAAsymphony SP are the same for independent runs (which allow use of the **Wizard**) and integrated runs.

Note: If you need assistance for using the QIAAsymphony SP, we recommend using the **Wizard**. The QIAAsymphony SP **Wizard** is comprehensive and easy to understand, providing step-by-step instruction for loading QIAAsymphony drawers.

8.2 Loading the “Waste” drawer

Used 8-Rod Covers and sample prep cartridges are discarded by the robotic gripper into the “Waste” drawer and are collected in 4 unit boxes in the drawer.

A container in the “Waste” drawer collects liquid waste from the sample preparation procedure.

Used disposable filter-tips are discarded into a tip disposal bag or waste bin. A tip park station in the waste drawer allows used tips to be temporarily stored on the worktable for reuse in a later protocol step.



- 1** Tip disposal bag
- 2** Tip chute
- 3** Liquid waste container
- 4** Tip park station
- 5** Empty unit boxes

We recommend loading items into the “Waste” drawer in the following order:

1. Insert empty liquid waste container (be sure to remove lid before placing into the drawer).
2. Insert tip chute.
3. Insert tip park station.
4. Insert empty unit boxes (make sure there is an empty unit box in slot 4).
5. Install empty tip disposal bag.

8.2.1 Tip park station

The tip park station is on top of the liquid waste container. It channels liquid waste from the filter tips into the liquid waste container and also enables temporary storage of filter-tips that will be reused in a subsequent protocol step.

To load the tip park station into the “Waste” drawer, follow the steps below.

1. Open the “Waste” drawer.
2. Ensure that the tip park station is properly inserted; otherwise an error may occur during the inventory scan.

The tip park station will be automatically detected during the inventory scan.

8.2.2 Liquid waste container

The liquid waste container is used to collect all liquid waste generated during sample preparation.

To load the liquid waste container into the “Waste” drawer, follow the steps below.

1. Open the drawer.
2. Place the liquid waste container at the rear right.
3. Gently press the container downwards to put it properly in place.

Note: Make sure to remove the lid from the liquid waste container before you load the container into the drawer.

Note: Make sure to empty the liquid waste container at the end of each run.

Note: Be careful when handling the liquid waste container. It may contain infectious material.

Note: The “Waste” drawer can only be closed when the liquid waste container is in place.

Note: Do not autoclave the liquid waste container.

8.2.3 Tip chute

The tip chute enables collection of used disposable filter-tips from the pipetting system. Used tips are collected in a tip disposal bag or, when using the QIASymphony Cabinet SP/AS, a waste bin.

Note: Make sure that the tip chute is placed into the “Waste” drawer. Install a tip disposal bag or position the waste bin before running a sample batch.

Note: If using the QIASymphony SP instrument with the QIASymphony Cabinet SP, refer to the *QIASymphony Cabinet SP/AS User Guide* for information about setup of the tip chutes.

The tip chute will be detected during the inventory scan.

8.2.4 Tip waste collection

Tip disposal bag

When using the QIASymphony SP instrument without the QIASymphony Cabinet SP, the tip disposal bag must be mounted below the “Waste” drawer.

For more information, refer to Section 9.6, “Mounting the tip disposal bag”, of the *QIASymphony SP/AS User Manual – General Description*.

If using the QIASymphony SP in combination with the QIASymphony Cabinet SP, refer to the *QIASymphony Cabinet SP/AS User Guide* for information about tip disposal.

Note: The instrument does not check for the presence of a tip disposal bag. If a QIASymphony Cabinet is not used and a tip disposal bag is not installed, tips will not be collected and will fall to the surface below the instrument.

Waste bin

When using the QIASymphony Cabinet SP, tips are disposed directly into the waste bin, located below the waste chute exit.

8.2.5 Unit boxes

Used sample prep cartridges and 8-Rod Covers are collected in unit boxes. There are 4 slots for unit boxes in the “Waste” drawer and, for increased ease of use and process safety, unit boxes can only be loaded in the correct orientation.

Depending on the purification procedure being run and the number of samples, the space needed for used consumables in the “Waste” drawer will vary.

To load the “Waste” drawer with unit boxes, follow the steps below.

1. Remove the lid from the unit box.
2. If the unit box contains a spacer, make sure to remove this.
3. Place the unit box into one of the unit box slots.

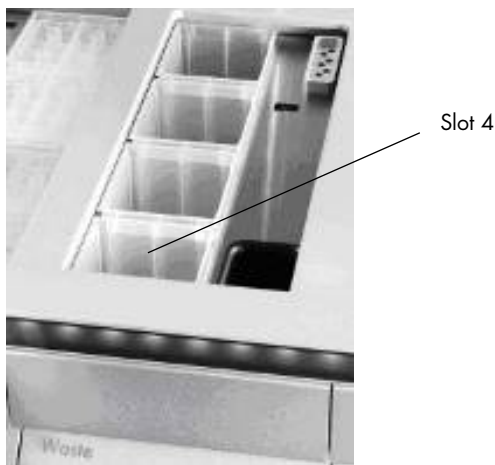

Unit box slots (slot 4 indicated).

Note: The spacer at the bottom of an empty 8-Rod Cover unit box must be removed before the unit box is placed into the “Waste” drawer, otherwise an error may occur during the inventory scan.

Note: An empty unit box must be placed into slot 4. During initialization, the handler goes down into the unit box in position 4. If the unit box is not empty, the handler will crash.

Note: Do not empty partially filled unit boxes. Partially filled unit boxes will be detected during the inventory scan and can be used until they are full.

Note: Do not throw away the lids of open unit boxes. They can be used to cover unit boxes afterwards.

8.2.6 Closing the “Waste” drawer

After preparing the “Waste” drawer, the drawer must be closed to initiate the inventory scan.

8.3 Loading the “Eluate” drawer

8.3.1 Features of the “Eluate” drawer

Purified nucleic acids are transferred to the “Eluate” drawer. The “Eluate” drawer contains 4 slots that can be used for elution into plates or tubes.

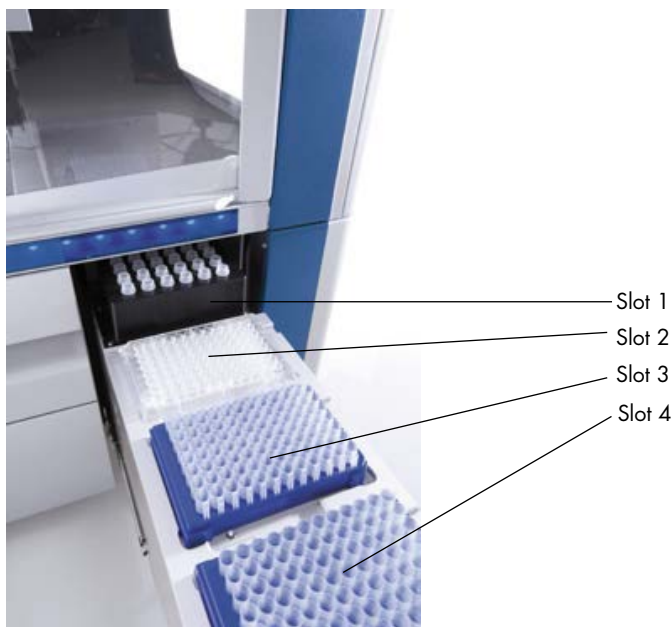

The “Eluate” drawer.

“Elution slots 2–4” can accommodate plates or tubes in special adapters.

- Slot 1 “Elution slot 1” enables eluate cooling and requires use of a specially designed cooling adapter for various plate formats (e.g., 96-well, PCR tubes). Cooling parameters are defined in the protocol. In some protocols, the user may be able to choose whether to leave eluate cooling on or to turn it off. However, we do not recommend turning off eluate cooling if this is required by the protocol.
- Slot 2 “Elution slot 2” and “Elution slot 3” can accommodate 96-well plates, 24-well plates, and tubes.
- Slot 3
- Slot 4 “Elution slot 4” can accommodate 24-well plates or tubes in special adapters. For technical reasons, 96-well elution racks cannot be used on “Elution slot 4”.

Adapters

Adapters are available for the following types of consumables:

- Microplate, round bottom
- Sarstedt® screw-cap tubes (2 ml)
- PCR plate
- 96-well plates
- Snap cap microtubes
- Elution Microtubes CL (cat. no. 19588)

For more information about the types of 96-well plates and tubes that can be used in the “Eluate” drawer, visit www.qiagen.com/goto/QIASymphony.

Note: Ensure that elution racks or tubes are compatible with the QIASymphony SP.

If multiple sample batches are being processed, eluted nucleic acids can be removed from the “Eluate” drawer as soon as each batch is ready. The “Eluate” drawer will unlock and the “E” button will become green. The green color of the “E” button informs the user that eluates may be removed.

Note: Ensure that the plates and racked tubes are held securely in the slot by the white pins.

Note: A handheld scanner is used to identify bar codes on elution racks and elution slots in the “Eluate” drawer.

8.3.2 Loading procedure

To load the “Eluate” drawer, follow the steps below.

1. Prepare the elution racks.
2. If required, place elution racks into the appropriate adapter.
3. Open the “Eluate” drawer to display the **Elution Slot/Configure Racks** screen.
4. Press the slot button in the touchscreen of the elution slot that you want to add a rack to.
5. If the elution rack is bar code labeled, scan the bar code using the handheld scanner. Alternatively, press **Rack ID**, and enter the elution rack ID manually using the **Keyboard** screen that appears.

Note: This step is optional for some instruments, depending on the configuration. For more information, refer to the *QIASymphony SP/AS User Manual – General Description*.

The entered elution rack ID is displayed in the screen. The slot is colored yellow to indicate that the rack type needs to be defined.

Note: In case of using an eluate rack with 2D bar coded tubes, the eluate tube bar code is appended to the ID of the sample ID with a blank in between within the result file. Make sure that Rack ID is identical to Rack ID used during manual scan of eluate rack on the external 2D bar code reader. See Section 6.2.2 in the *QIASymphony SP/AS User Manual – General Description*, for more information on enabling eluate racks with 2D bar coded tubes.

6. Place the elution rack with well A1 in the upper left corner onto the desired elution slot. Make sure that the rack is held securely by the white pins.

If the protocol requires eluate cooling or if you are planning to set up an integrated run, make sure to use slot 1. Place the elution rack into the appropriate cooling adapter.

Note: Elution rack cooling can be turned off by pressing the snowflake button to the left of “Elution slot 1”. We do not recommend turning off elution rack cooling if this is required by the protocol.

7. An adapter may be required depending on the elution rack being used.

Select the elution rack type from the list. Use the up and down arrows to scroll through the list.

Note: The QIASymphony SP provides automated assignment of elution racks. If you are using an Elution Microtube Rack (EMTR), scan the bar code of the rack and the elution rack type will be automatically selected by the QIASymphony SP.

Note: If applicable, remove the lid of the eluate labware before loading.

Note: If using Elution Microtubes CL racks, remove the bottom by gently twisting the rack until the bottom separates before loading into the respective cooling adapter.

Note: If the elution rack was used in a previous run, cooling will be switched on by the QIASymphony SP automatically when the next batch requiring eluate cooling is ordered.

Note: The maximum number of columns that can be reserved depends on the rack size and on the batches that are already queued for that slot.

Important: If there are already eluates in an elution rack from a previous run loaded in the “Eluate” drawer, ensure that the cooling temperatures are suitable for these eluates on the same elution rack. Otherwise, the eluates may be given the status “invalid”. The QIASymphony SP cannot detect whether cooling temperatures are suitable for eluates that are already loaded from previous runs in the “Eluate” drawer.

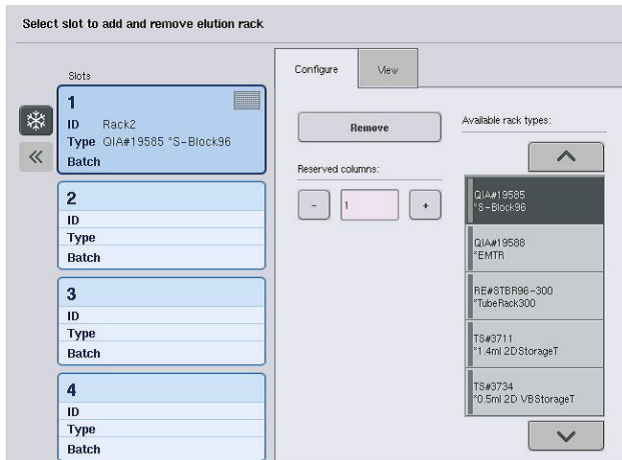

8. If you need to load more elution racks in the “Eluate” drawer, repeat the loading procedure as previously described in this section before proceeding to the next step.
9. Close the “Eluate” drawer and press **OK**.

The QIAasymphony SP performs an inventory scan of the “Eluate” drawer. Sample processing pauses and the robotic arm moves to the “Eluate” drawer to check that selected elution slots contain an elution rack.

Note: It is not possible to proceed to the next screen until the inventory scan is complete.

8.3.3 Transfer module

Within the integrated mode, elution racks can be automatically transferred from the QIAasymphony SP via the transfer module to slot 2 of the “Eluate and Reagents” drawer of the QIAasymphony AS instrument.

The transfer frame consists of a base frame and a handle. If you intend to use automatic transfer of an elution rack to the QIAasymphony AS via the transfer module, ensure that the transfer frame is installed before placing the relevant adapter onto slot 1 of the “Eluate” drawer.

To install the transfer frame, follow the steps below.

1. Place the transfer frame onto slot 1, so that the 4 pins under the base frame fit into the screw holes of slot 1. The handle should face toward the back-left corner of slot 1.

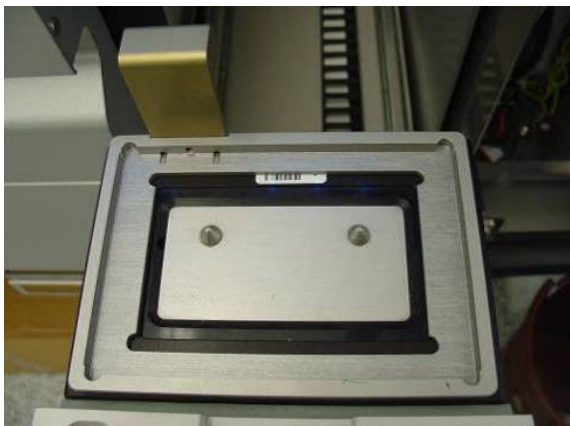

Transfer frame placed onto slot 1 of the "Eluate" drawer.

2. Place the appropriate adapter and elution rack on top of the transfer frame.

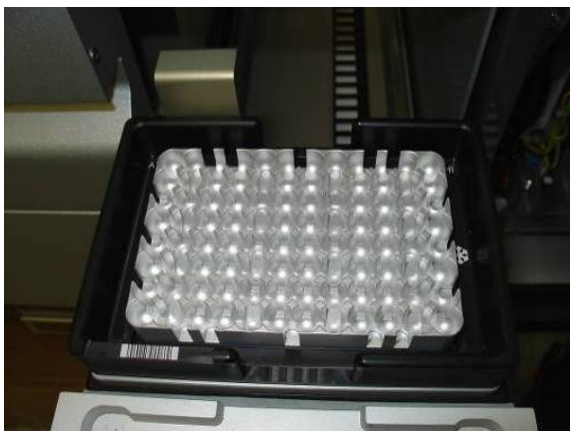

Adapter placed onto the transfer frame on slot 1 of the "Eluate" drawer.

The "Eluate" drawer is locked during:

- Transfer of eluates from sample prep cartridges to the elution rack
- During the inventory scan of the "Eluate" drawer
- During transfer of eluates from the QIA Symphony SP to the QIA Symphony AS via the transfer module
- During an integrated run

At all other times, the "Eluate" drawer can be opened or closed.

8.3.4 Unloading the “Eluate” drawer

Elution racks must be manually unloaded from the “Eluate” drawer.

If using QIASymphony SP/AS instruments in integrated run mode, an elution rack on “Elution slot 1” will be automatically transferred from the QIASymphony SP to the AS module to start the reaction setup. Afterwards, the elution rack will be automatically transferred back to the QIASymphony SP “Eluate” drawer.

If using QIASymphony SP/AS instruments in the independent mode, the elution rack can be directly transferred to the “Eluate and Reagents” drawer of the QIASymphony AS by using the **Transfer** button.

To transfer elution racks from any elution slot other than “Elution slot 1”, a manual transfer must be performed. For increased flexibility, elution racks can be removed from the “Eluate” drawer before a protocol run in independent mode has finished. As soon as eluates have been transferred to an elution rack, the elution rack can be removed from the drawer.

Note: If the rack will be used for another batch, it is not possible to remove the elution rack from the drawer.

Note: If an elution rack is ready to be unloaded, the “E” button in the status bar at the bottom of the touchscreen becomes green.

Note: For sample preparations without internal controls, check presence of eluate for each sample processed.

When an elution rack is removed, the rack file for the elution rack is finalized and the result file for the elution rack is generated. The rack file and result file can be downloaded using the QIASymphony Management Console or via file transfer from the QIASymphony SP to the USB stick.

For a detailed description of how to manually remove elution racks, see the following sections.

Manually removing an elution rack

1. Open the “Eluate” drawer.
The **Eluate Drawer/Elution Slot** screen appears.
2. Select the elution slot from which the elution rack should be removed.
The **Eluate Drawer/Elution Slot/Change Rack X** screen appears.

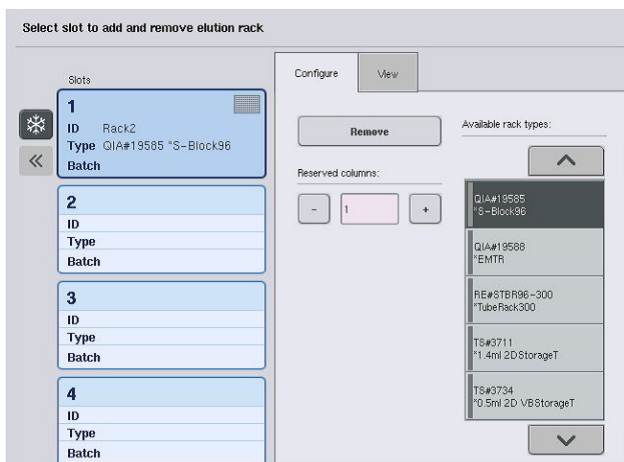

3. Press the **Remove** button in the **Configure** tab to remove the elution rack from the inventory.



A message asking whether you want to remove the elution rack from the selected slot appears.



4. Press **Yes** to continue.

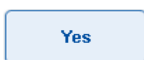

The **Eluate Drawer/Elution Slot/Change Rack X** screen is displayed. The rack on the selected slot is removed.

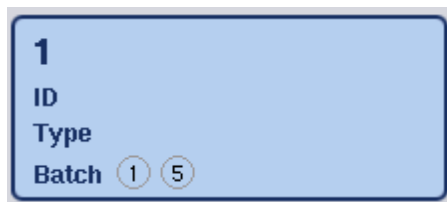

5. Remove the elution rack from the elution slot.
If the elution rack was used with an elution adapter, also remove the adapter.
6. To unload additional elution racks, repeat the process.
7. When all elution racks have been unloaded, close the "Eluate" drawer.

The **Eluate Drawer/Elution Slot/Configure Rack X** screen appears.

8. Press **OK**.



The QIA Symphony SP performs an inventory scan of the “Eluate” drawer. Afterwards the **Sample Preparation/Overview** screen is displayed.

Note: If eluate cooling in “Elution slot 1” was turned on, it will be turned off as soon as the **OK** button or **Yes** button is pressed.

8.4 Loading the “Reagents and Consumables” drawer

The “Reagents and Consumables” drawer accommodates all consumables and reagents required for the protocol run.

Before starting a protocol run, the drawer must be loaded with the appropriate reagents in prefilled, sealed reagent cartridges, sample prep cartridges, 8-Rod Covers, and disposable filter-tips. In some cases, an Accessory Trough and buffer bottle may be required.

Depending on the kit being used, different types or amounts of consumables may be required. For more information, refer to the handbook of the QIA Symphony Kit you are using.

8.4.1 Loading consumables

Unit boxes

Consumables required for sample preparation are placed onto the QIA Symphony SP worktable in unit boxes. Unit boxes are provided with a lid. There are 4 slots for unit boxes.

To load unit boxes, follow the steps below.

1. Remove the lid from the unit box and keep for later use. Lids can be used to reclose partially used unit boxes.
2. Place unit boxes containing either unused 8-Rod Covers or sample prep cartridges into the “Reagents and Consumables” drawer.

Unit boxes are designed so that they fit into the instrument drawer only in the correct orientation.



Consumables used in sample preparation on the QIAAsymphony SP.

Each unit box slot in the “Reagents and Consumables” drawer can be used either for a unit box filled with sample prep cartridges or a unit box filled with 8-Rod Covers. Partially used unit boxes can be loaded into the drawer since the number of sample prep cartridges or 8-Rod Covers they contain will be detected during the inventory scan.

Typically, more sample prep cartridges will be required than 8-Rod Covers and this needs to be taken into account when loading the QIAAsymphony SP with unit boxes.

Note: Make sure that there is at least one empty unit box in slot 4 (slot closest to you).

Note: Do not refill partially used unit boxes. The number of sample prep cartridges or 8-Rod Covers is detected during the inventory scan.

Note: Do not throw empty unit boxes away. Empty unit boxes can be used in the “Waste” drawer for collection of used sample prep cartridges and 8-Rod Covers during the purification procedure.

8-Rod Covers

An 8-Rod Cover is an array of 8 rod covers that cover the magnetic rods of the magnetic head.

- Each unit box can hold a maximum of twelve 8-Rod Covers.
- There is a spacer between the bottom of the unit box and the last 8-Rod Cover.
- A specific pattern on the top and bottom edge of an 8-Rod Cover enables automatic detection by the QIAAsymphony SP during the inventory scan.
- The number of 8-Rod Covers in a unit box is also detected during the inventory scan.

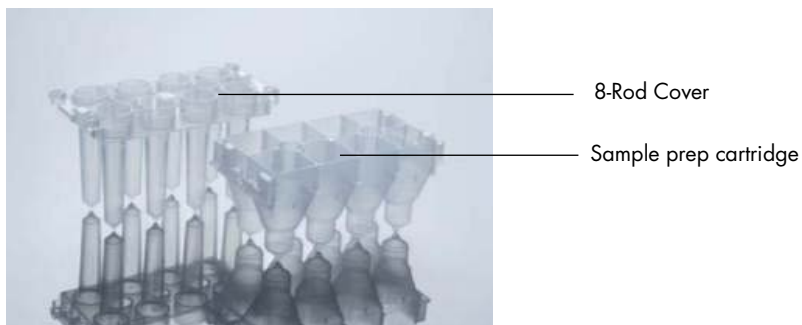

8-Rod Covers and sample prep cartridge.

Sample prep cartridges

Sample prep cartridges are the vessels used by the QIASymphony SP during purification of nucleic acids. Each well of a sample prep cartridge can hold up to 3 ml of liquid.

Sample prep cartridges are provided in sealed unit boxes. Each unit box can hold a maximum of 28 cartridges. A specific pattern on the top and bottom edge of a sample prep cartridge enables automatic detection by the QIASymphony SP during the inventory scan. The number of sample prep cartridges in a unit box is also detected during the inventory scan. The robotic handling system can pick up a maximum of 3 sample prep cartridges simultaneously.

Tip racks

- The QIASymphony SP uses 1500 μ l filter-tips and 200 μ l filter-tips.
- Filter-tips are provided in sealed blister packs, with 32 filter-tips in one tip rack.
- For increased ease of use, racks containing 1500 μ l filter-tips are black and racks containing 200 μ l filter-tips are blue.
- Each type of tip rack has a different pattern on the upper and lower side. This enables detection of the type of filter-tip during the inventory scan.
- There are 18 tip rack slots.
- Tip racks can be placed in any of the slots since rack position, tip type, and number of tips are detected during the inventory scan.
- The number of tips required per sample varies depending on the protocol being run.

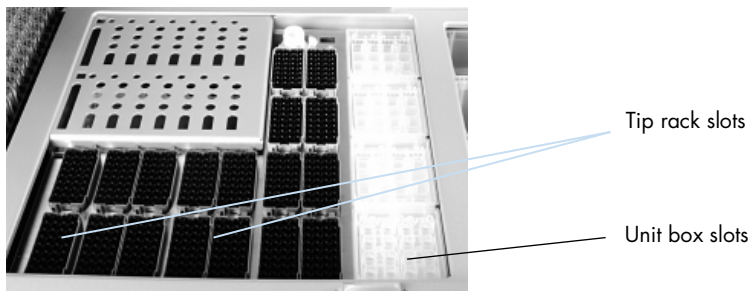

Tip racks.

To load the QIASymphony SP with tip racks, follow the steps below.

1. Hold the tip rack between 2 fingers by the recessed grips.
2. Gently squeeze the tip rack together and place it into a tip rack slot.

Note: To ensure detection of the tip racks during the inventory scan, make sure that the tip racks are properly seated in the tip rack slot and that none of the protrusions on the tip racks are broken.

Note: Each tip type contains a filter to help prevent cross-contamination.

Recommendation: Load more than the required number of filter-tips of each size so that sufficient filter-tips are available for automated error handling.

In addition, we recommend to load tips preferably in the rear tip rack slots.

For more information about tip loading, press the "R+C" button to open the **Consumables/Cartridges/Filter-Tips** screen or press the **Tip Information** button in the QIASymphony AS **Loading Information** screen (see "Loading disposable filter tips", page 121).

Note: Do not refill partially used tip racks. A mixture of various tip sizes in one rack will result in an error during the run. The number of filter-tips will be detected during the inventory scan.

8.4.2 Reagent cartridges

The required reagent cartridges are determined by the QIASymphony SP from the protocols that were chosen by the user.

The reagent cartridges can be either from the same kit or from different kits.

- Reagents required for the purification procedure are provided in prefilled, sealed reagent cartridges.
- Up to 2 reagent cartridges can be loaded into the "Reagents and Consumables" drawer.
- For increased ease of use, reagent cartridges fit only in the correct orientation.

1. The user first vortexes the magnetic-particle trough and then removes the seal from the magnetic-particle trough. (Refer to the relevant kit handbook for detailed information.)
2. Remove the lids from the tubes and place into the appropriate slot to prevent mix-up.

When the piercing lid has been properly installed before loading, the reagent cartridge is then automatically opened by the QIAAsymphony SP, which eliminates manual handling and pouring of reagents.

Note: The piercing lid has sharp edges and can damage your gloves.

- Each individual reagent in the reagent cartridge is labeled with a 2D bar code, enabling tracking of reagents through the entire purification procedure.
- Before the run starts, the system checks whether the reagent volumes are sufficient for the chosen protocol.

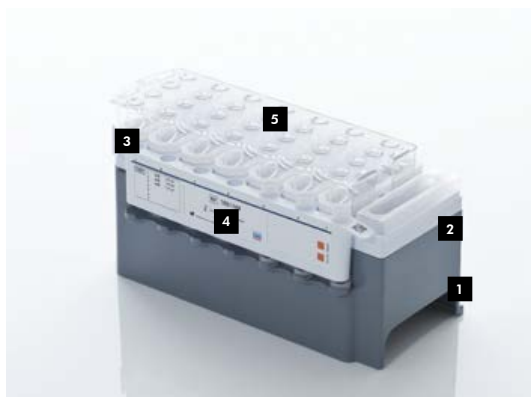

- 1 Reagent cartridge holder
- 2 Magnetic-particle holder
- 3 Reagent troughs
- 4 Enzyme rack
- 5 Piercing lid

The reagent cartridge contains sufficient reagents for up to 192 samples, depending on the kit being used. Troughs of partially used reagent cartridges should be sealed immediately after use with Reuse Seal Strips (provided in the QIAAsymphony Kit).

Note: Do not refill partially used reagent cartridges or exchange the reagent cartridge of a running batch as this may lead to performance and pipetting errors.

Note: The length of time that the reagent cartridge is open must be kept as short as possible.

All reagent troughs and enzyme racks are labeled at the side with the name of the buffer contained in the trough. A unique 2D bar code on top of each trough enables the QIAAsymphony SP to detect the reagent cartridge and the contents of each trough.

The composition of the reagent cartridge is kit-specific. Do not mix troughs from different kits or kits with different lot numbers.

Visually check all reagent troughs for precipitates. If precipitates are present, refer to the handbook of the QIAAsymphony Kit you are using for more information.

Note: Make sure that reagents and enzymes are at room temperature (15–25°C) before placing into the “Reagents and Consumables” drawer.

Note: Do not autoclave a prefilled reagent cartridge. Do not change the order of the troughs within the reagent cartridge.

Note: Avoid shaking the reagent cartridge since this may cause buffers to foam, resulting in liquid-level detection errors.

8.4.3 Buffer bottle

Depending on the kit being used, an additional bottle of buffer may be provided. The bottle is prefilled with up to 60 ml of reagent.

To load the QIAAsymphony SP with the buffer bottle, follow the steps below.

1. Remove the screw-cap from the buffer bottle.
2. Press **Bottle ID** in the **Load Reagents** screen.
3. Scan the buffer code by using the handheld bar code scanner. Alternatively, type in the bar code using the **Keyboard** screen.
4. Place the bottle into the slot behind the rear end of the tip rack slots 1 and 2.



Buffer bottle slot.

The buffer bottle and volume of buffer will be automatically detected during the inventory scan.

8.4.4 Accessory Trough

If the purification procedure requires additional ethanol, this must be poured by the user into an Accessory Trough, which is then placed into either tip rack slot 5 or 12. These slots can be used for either tip racks or Accessory Troughs.

If additional ethanol is required, refer to the relevant kit handbook for the volume to be used.

To load the QIASymphony SP with an Accessory Trough, follow the steps below.

1. Fill the Accessory Trough(s) with the volume of ethanol stated in the handbook of the QIASymphony Kit you are using.
2. Place the Accessory Trough(s) into tip rack slot 5 and/or 12.

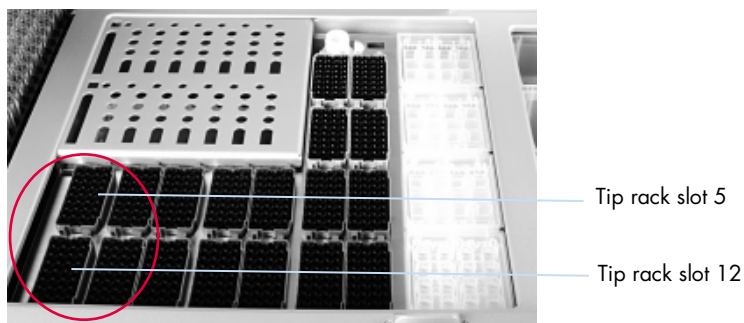

Position of Accessory Trough(s).

Note: Make sure that the Accessory Trough is properly seated in the tip rack slot otherwise an error may occur during the inventory scan.

8.4.5 Unloading reagents and consumables

Reagent cartridges

To remove a reagent cartridge from the “Reagents and Consumables” drawer, follow the steps below.

1. Open the drawer.
2. Pull the reagent cartridge to the left and slide it out of the slot.

To avoid evaporation of reagents, we strongly recommend resealing the troughs of the reagent cartridge immediately after use. Reseal the troughs using Reuse Seal Strips provided in QIASymphony Kits. Replace screw-caps on the tubes in the enzyme rack.

For storage, remove the reagent cartridge from the reagent cartridge holder and store according to the instructions in the kit handbook. The reagent cartridge holder can then be used in combination with other kits. Store the enzyme rack according to the instructions in the kit handbook.

If the reagent cartridge is empty, remove it from the reagent cartridge holder and discard it according to your local safety regulations.

Tip racks

Tip racks can be left in the “Reagents and Consumables” drawer. Tip racks only need to be removed in the following situations:

- The tip racks are empty.
- Maintenance will be performed (e.g., decontamination using the UV lamp).
- The instrument will not be used for a long period of time.

To remove a tip rack from the QIAsymphony SP, follow the steps below.

1. Hold the tip rack between two fingers by the recessed grips.
2. Gently squeeze the tip rack together.
3. Remove the tip rack.
4. If you need to remove the tip racks prior to performing maintenance procedures, the tip racks can be replaced after maintenance has been performed.

Unit boxes (8-Rod Covers and sample prep cartridges)

Unit boxes can be left in the “Reagents and Consumables” drawer. Unit boxes only need to be removed in the following situations:

- The unit box is empty.
- Maintenance will be performed (e.g., decontamination using the UV lamp).

To remove a unit box from the “Reagents and Consumables” drawer, follow the steps below.

1. Open the “Reagents and Consumables” drawer.
2. Grasp the unit box by its upper edge.
3. Pull it out of the drawer.
4. Replace the lids of partially used or unused unit boxes.
5. Empty unit boxes must be saved for collection of used sample prep cartridges and 8-Rod Covers in the “Waste” drawer.

8.5 Loading the “Sample” drawer

Samples can be loaded into the “Sample” drawer in either primary or secondary tubes. For more information about compatible tubes, visit www.qiagen.com/goto/QIASymphony.

Use of tube carriers enables samples to be loaded in a variety of formats. A tube carrier for up to 24 primary tubes or tubes containing internal controls with diameters of 8–16 mm can be used with the QIASymphony SP.

8.5.1 Loading tube carriers

Loading samples using a tube carrier

The QIASymphony SP tube carrier can accommodate up to 24 sample tubes of the following outer diameter:

- 14–16 mm (no insert required)
- 13 mm (tube insert 1a; cat. no. 9242058)
- 11 mm (tube insert 2a; cat. no. 9242057)
- Insert Sarstedt tube 2 ml (insert 3b; cat. no. 9242083)
- Insert snap cap tube (insert 5a; cat. no. 9244701)



Example of insert for tube carrier.

Note: Place the tubes into the tube carrier in a way that all bar codes are oriented to the left so that they can be read by the bar code reader.

Note: Depending on the **Configuration Profile**, only bar code labeled sample tubes can be used. If other tubes are used, a batch or run cannot be defined.

The instrument detects tube size by reading the bar code on the insert or on the tube carrier. If a tube is used that is not the default tube type for a certain insert, the user must specify the tube type when defining the sample batch. Default tubes can also be configured.

Inserting samples using a tube carrier

1. Open the "Sample" drawer by pulling the door toward you.

Five slots are available: The first 4 slots can accommodate tube carriers containing sample tubes; the fifth slot "A" accommodates a tube carrier containing internal control.

The status of each slot is shown by LEDs located behind the stop line. The LEDs may be illuminated in green, orange, or red.

Green — slot is free and ready for loading

Orange — tube carrier is loaded

Red — slot is currently locked



Stop line
Slot 1-4 Slot A

Examples of slot status LED illumination.

2. Gently slide the tube carrier into the appropriate slot. Insert up to the stop line, and wait until the bar code reader has moved forward.



Sliding a tube carrier into the appropriate slot.



Bar code reader (laser)

Spacer

Locations of bar code reader and spacer.

3. As soon as the bar code reader is in position, the slot unlocks and the green LED starts to flash. Slide the carrier into the slot until it locks.
4. The bar code reader reads bar codes on the carrier, inserts, and corresponding sample tubes (if bar coded). Upon successful loading, the LED changes from green to orange.
5. The bar code reader returns to the home position.
6. To add more sample tubes in different slots, follow procedure as described in this section. Otherwise close the "Sample" drawer.

Note: Be sure to support the tube carrier with your second hand during the loading process. Otherwise, there is a risk of handle breakage.

Note: Make sure to slide the carrier smoothly into the slot otherwise an error may occur.

Note: Only a tube carrier containing internal control can be loaded into "Slot A". Tube carriers containing samples must be loaded into "Slot 1", "Slot 2", "Slot 3", or "Slot 4".

Note: If you need to load two tubes with the same bar code/ID in the same tube carrier, do not place them side by side. Otherwise an error will occur.

Note: If you are using sample tubes that are not labeled with bar codes and that are in different inserts, use either one insert type per tube carrier or leave at least one position empty between different types of insert.

Note: If you are using sample tubes that are not labeled with bar codes and the QIASymphony SP has a configuration other than configuration 3, tubes containing smaller volumes of liquid or clear liquids may not be detected. In this case, use a blank bar code label to enable detection of the sample tube.

Note: To ensure correct liquid level detection, push the tubes down to the bottom of the tube carrier or insert, if inserts are used.

Continuous loading

It is also possible to load and queue additional samples when a run is already in progress. In this mode, you can only assign Assay Control Sets that are compatible with the currently loaded reagent cartridge.

Continuous loading on the QIASymphony SP is possible for up to 96 samples in any number of batches, provided that the consumables drawer is fully loaded before commencing the first batch.

After loading the samples, the system allows the user to correct bar code reading errors, change labware, assign Assay Control Sets, and define the elution slot and volume.

Before starting a run with continuous loading, ensure that:

- Enough tips, reagents, waste space and consumables are loaded for all runs including subsequent runs loaded via continuous loading.
- The elution rack is correctly positioned in the "Eluate" drawer before setting up a batch. If you need to assign an elution slot during batch setup (while a run is active), only the slots that already contain racks may be used.
- Elution racks are set up before a run is started. This ensures that multiple scans of the "Eluate" drawer are not performed. Every time a scan is performed, the current run is paused.

Unloading a tube carrier

If the tube carrier slot is not locked (LED is not illuminated red), the tube carrier can simply be removed from the slot. The tube carrier can be removed as soon as the samples have been transferred.

Depending on the batch status, different actions can be carried out after removing the tube carrier.

Removing a batch loaded in the tube carrier

If samples are loaded in a tube carrier, the batch can be removed.

Status	Action	Description
QUEUED, STOPPED or COMPLETED	Simply remove the tube carrier from the corresponding slot.	Tube carrier was not removed before stop or completion.
STOPPED or COMPLETED		Tube carrier was removed before end of batch.

To remove a batch loaded in the tube carrier, follow the steps below.



1. Press the **SP Batch** button in the **Sample Preparation/Overview** screen.
A message will appear that asks whether you want to remove the batch.



2. Press **Yes** to confirm.

Loading internal controls

If a protocol requires the use of an internal control, the internal control to be used is defined in the corresponding Assay Control Set. Assigning an Assay Control Set to a sample not only specifies which protocol should be used but also which internal control should be added to the sample.

The QIASymphony SP supports the use of internal controls only in combination with samples that are loaded in a tube carrier.

Note: Internal controls must be loaded via a tube carrier in sample "Slot A".

Note: Do not load internal controls into "Slots 1–4".

Eight different internal controls can be used per batch of 24 samples and up to 24 different internal controls can be used for one run. Tubes containing internal control must be placed into the appropriate insert for the tube type before loading into the tube carrier.

Loading of the required internal controls for ordered batch(es) is validated before run start.

If the tubes containing internal control are bar code labeled and identification of the tubes is defined in an Assay Control Set, the QIAAsymphony SP automatically detects which internal control is located in each position.

If the tubes are not bar code labeled, information about the internal control must be entered manually.

After insertion of the tube carrier into "Slot A", follow the steps below to enter information about the internal control.

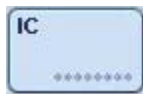

1. Press the **IC** button to check or modify the internal controls.

The **Internal Controls** screen appears.

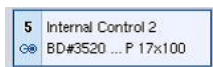

2. Select the position that needs an internal control to be manually assigned by pressing the button.



3. Select the internal control in the **Internal controls:** list.



4. Press **OK** to assign internal controls to the selected positions.

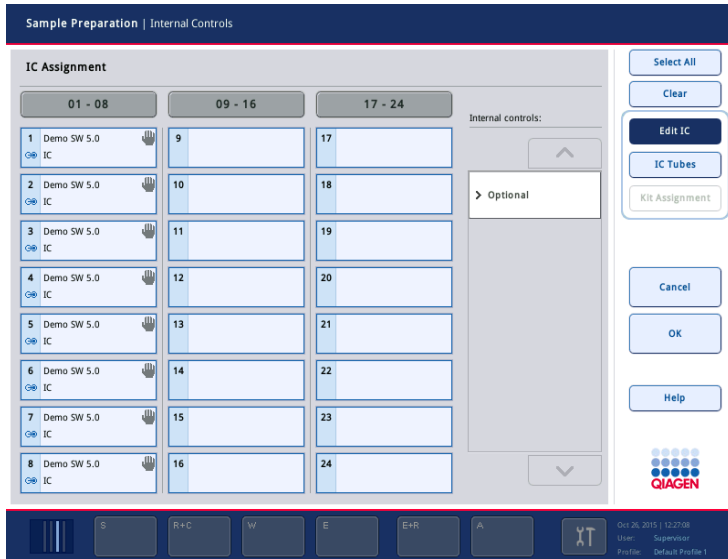

5. Press **OK** to confirm the overall assignments of internal control.

Internal controls are ordered into 3 groups:

- Optional All internal controls known to the instrument that are not categorized as “Required” or “In use” appear under “Optional”.
- Required Batch(es) is(are) queued. The QIAAsymphony SP knows which internal controls are required to run the queued batches. The required internal controls are not detected automatically and have to be assigned to the detected positions
- In use The QIAAsymphony SP either has automatically detected an internal control or it was manually assigned to a particular position in the fifth tube carrier. These internal controls are listed under the category “In use”.

Note: If the internal control was labeled with a bar code but the bar code was not correctly read, the associated position button becomes yellow. To continue, the internal control has to be manually assigned using the internal controls displayed in the **Internal controls:** list. If the internal control was not labeled with a bar code but the QIAAsymphony SP detected that a tube was present, **Unknown IC** is displayed in the corresponding position. The internal control has to be manually assigned using the internal controls displayed in the **Internal controls** list.

Note: Although you can leave this screen without manually assigning the positions labeled **Unknown IC**, be sure to assign all required internal controls before starting a run; otherwise the run cannot be started.

Unloading internal controls

Internal controls in a tube carrier can be removed from the QIASymphony SP when the carrier slot is unlocked.

- If batches are running and you need to load additional internal controls, press the **IC** button to unlock the carrier “Slot A”.
- If the QIASymphony SP does not need to access the tube carrier in “Slot A”, the internal controls can be unloaded.
- Remove the carrier with internal controls from “Slot A” by gently sliding it out of the “Sample” drawer.

The status of the internal controls changes from **LOADED** to **ON HOLD**. The QIASymphony SP will retain the information about the internal controls provided earlier.

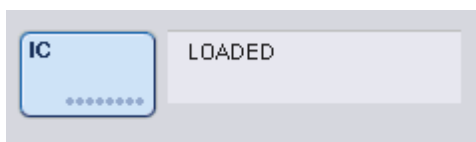

Under the described conditions, **ON HOLD** would be visible where **LOADED** appears in the image above.

Loading internal controls during a run

After unloading the tube carrier containing the internal control, the tube carrier containing a new internal control has to be inserted again. Define internal control(s) as described in “Loading internal controls”, page 79.

For more information, refer to Section 2.20.4, “Loading internal controls during a run”, of the *QIASymphony SP/AS User Manual – Operating the QIASymphony SP*.

8.5.2 Loading the plate carrier

The plate carrier can also be used for sample input. For more information, refer to the *QIASymphony SP/AS User Manual – General Description*. If you intend to use the plate carrier, contact QIAGEN Technical Services.

8.6 Performing inventory scans (SP)

An inventory scan of each drawer of the QIAAsymphony SP must be performed before a sample preparation protocol can be run. The QIAAsymphony SP uses a laser to check the type and number of consumables, and the type and location of adapters loaded in each drawer. A bar code detection system recognizes and scans 1D or 2D bar codes (e.g., on the reagent cartridge). The laser and bar code camera are integrated in the robotic arm. This ensures that positions over the whole worktable can be scanned. The inventory scan is drawer-specific. This means that only the drawer that has been opened will be scanned for changes.

8.6.1 Inventory scan of the “Reagents and Consumables” drawer

The inventory scan of the “Reagents and Consumables” drawer is divided into 2 main parts, each with several subparts.

Laser scan — reagent cartridge

Reagent cartridge slots are scanned. The instrument will check first for sealed troughs in the respective reagent cartridge.

Note: If you forget to place the lid onto the reagent cartridge, the samples in the batch may be lost. However, the presence of the piercing lid is detected during the inventory scan, which means that the error will be detected before the run has started.

Note: Ensure that all 2D bar codes are accessible by the sensor.

2D bar codes on reagent troughs, the magnetic-particle trough, and the enzyme rack are checked. In addition, the piercing status of the reagent cartridge is checked.



2D bar codes.

- If the reagent cartridge is sealed and not pierced, the liquid level of all reagents in the reagent cartridge is set to the original value. An additional liquid-level check will not be performed.
- Both reagent cartridge slots are scanned.

Note: Ensure that the buffer troughs fit correctly within the reagent cartridge, otherwise liquid-level detection errors may occur.

Note: Avoid shaking the reagent cartridge since this may cause buffers to foam, resulting in liquid-level detection errors.

Note: Do not refill partially used reagent cartridges or exchange the reagent cartridge of a running batch as this may lead to performance or pipetting errors.

Note: Do not mix enzyme racks, buffer, or magnetic-particle troughs from different reagent cartridges and/or different lot numbers.

Laser scan — tip rack slots

- All 18 tip rack slots are scanned to determine the type of tip rack loaded.
- All tip rack slots in which a tip rack was detected are scanned to determine the number of tips. If a tip is detected in the first and last position of the tip rack, the tip rack will be categorized as full. If the first or last tip is missing, a full scan will be performed to determine the number of tips in the tip rack.

Laser scan — unit boxes

- The unit box slots are scanned to detect the presence of unit boxes in the 4 slots.
- Afterwards, the type (8-Rod Cover or sample prep cartridge) and number of consumables are determined.

Liquid-level scan of detected reagents

This scan is only performed if the liquid level is not known (e.g., for a partially used reagent cartridge).

- Liquid-level scan of detected reagents.
- Liquid-level check of the buffer bottle (if detected).
- Liquid-level check of the Accessory Trough (if detected).

Note: The inventory scan will only enable detection of the liquid level of open and recognized vessels.

Note: These checks use 1500 µl and 200 µl filter-tips. If insufficient tips are available or if one of the tip types is missing, the inventory scan will be canceled and queued sample batches cannot be started.

Partial inventory scan

If you need to repeat an inventory scan for the “Reagents and Consumables” drawer (e.g., if a change has been made on the worktable), you can perform a partial inventory scan.

71703

Do you want to start the inventory scan on “Reagents and Consumables drawer”?

Tip Racks	<input type="button" value="Yes"/>	<input checked="" type="button" value="No"/>
Unit Boxes	<input type="button" value="Yes"/>	<input checked="" type="button" value="No"/>
Reagents	<input checked="" type="button" value="Yes"/>	<input type="button" value="No"/>
Buffer Bottle (optional)	<input type="button" value="Yes"/>	<input checked="" type="button" value="No"/>
Accessory Trough (optional)	<input type="button" value="Yes"/>	<input checked="" type="button" value="No"/>

8.6.2 Inventory scan of the “Waste” drawer

The inventory scan of the “Waste” drawer consists of a laser scan. It does not perform 2D bar code scans, liquid-level detection, or checks of the liquid waste container. It is therefore important that the user checks the liquid waste container and empties it before starting a batch.

Laser scan

- The tip park station slot is scanned. This checks that the tip park station is mounted.
- The tip chute slot is scanned. This checks that the tip chute is installed.
- The unit box slots are scanned. First, each of the 4-unit box slots is scanned to detect whether a unit box is in the slot. Afterwards, the content of each box is determined (e.g., amount and type of consumables in each box).

8.6.3 Inventory scan of the “Eluate” drawer

The QIASymphony SP checks the elution slots to make sure that selected elution slots contain an elution rack. It is possible to select the elution slots on which the bar codes of adapters will be scanned in the **Process SP 1** tab of the **Configuration** menu (i.e., none or 1–4).

If the QIAsymphony SP detects a discrepancy between the expected and actual elution rack(s) that are loaded in the “Eluate” drawer, a message appears in the touchscreen prompting the user to correct the problem. Open the “Eluate” drawer and place the elution rack(s) onto the correct position(s) or edit the slot/rack assignment in the touchscreen.

A message appears in the following situations:

- The detected bar code and the adapter bar code specified in the labware file are different.
- A bar code is detected but the selected labware file does not specify an adapter bar code.
- No bar code is detected, but the selected labware file specifies an adapter bar code that is required.

Note: The QIAsymphony SP only detects whether an elution slot is occupied by an elution rack or adapter and is not able to identify the elution rack type on the respective elution slot.

8.7 Starting, pausing, resuming, and stopping a run

8.7.1 Starting a run

As soon as a batch is queued, the **Run** button appears.

When you have finished defining the samples you want to process, press the **Run** button. The software will then validate the batches.

8.7.2 Pausing a run

A run can be paused by pressing the **Pause SP** button in the **Sample Preparation** tab. If a run is paused, the command being processed is completed before the run pauses. All running batches will be paused.

If the run is paused, two options are available: the run can be resumed or stopped.

Note: Pausing a run interrupts the sample preparation procedure. Only pause a run in an emergency.

Note: Pausing a run results in the processed samples being flagged as “unclear”.

8.7.3 Resuming a run

To resume a run, press the **Continue SP** button. If the run was paused, the samples will be flagged as “unclear”.

8.7.4 Stopping a run

Press the **Stop SP** button to stop the run. All batches currently being processed will be stopped. Other batches with the status **QUEUED** can be processed in another run after following the cleanup procedure.

If the run is stopped, all processed samples are flagged with “invalid”. It is not possible to process these samples further or to resume the run.

Canceled run

After stopping a run or if the run stops due to an error, the “S” button is flashing (see “Drawer buttons”, page 39). Press the “S” button to display the warning or error message. This message gives the hint to perform the cleanup procedure in the **Maintenance SP** screen.

Note: After successful cleanup, it is necessary to empty all slot positions in the “Sample” and “Eluate” drawers. New runs can then be defined and started.

8.8 End of batch processing or run

Note: If eluates in a completed batch or stopped run have been transferred to an elution rack that is only for eluates from this batch, the elution rack may be removed when batch processing is finished.

1. Unload elution rack(s).
2. Unload the tube carriers containing processed samples.
3. Optional: Unload internal controls (if not required for the next sample batch).
4. Remove the reagent cartridge (if it is not required for the next sample batch). Seal the troughs with Reuse Seal Strips and store according to the instructions in the kit handbook.

8.9 End of working day

1. Empty the liquid waste container.
2. Unload the unit boxes from waste drawer.
3. Unload all elution racks.
4. Remove consumables, reagent cartridges, buffer bottle, and Accessory Troughs.
5. Perform maintenance procedures described in Section 9 of the *QIASymphony SP/AS User Manual – General Description*.

For more information about unloading the reagents and consumables, see Section 8.4.5.

Note: Be sure to seal partially used reagent cartridges with Reuse Seal Strips. Store partially used reagent cartridges according to the instructions in the kit handbook.

Note: Sample prep cartridges in the unit boxes can contain residual liquid from the extraction run. Be sure to seal unit boxes with lids before disposal to avoid spillage of residual liquid.

9 QIASymphony SP Run Definitions

This section describes how to set up and configure a sample preparation run.

9.1 Configuring a sample type

Note: By default, the sample type is “Sample”. If your QIASymphony SP is not connected to a QIASymphony AS, ignore this section.

To change a sample to a positive extraction control (EC+) or negative extraction control (EC-), follow the steps below to ensure correct processing on the QIASymphony AS.



1. Press **ID/Type** in the **Sample Preparation/Batch/Define Sample** screen.

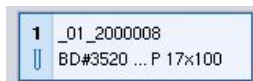

2. Select the samples for which the sample type shall be changed by pressing the corresponding buttons.



3. Press **EC+** or **EC-** to change the sample type from “Sample” to positive extraction control (EC+) or negative extraction control (EC-).

Note: Sample types are saved in the rack file for the corresponding elution rack. It is not possible to change the sample types later.

9.2 Use of virtual bar codes

Depending on the instrument configuration, the QIASymphony SP can generate unique, virtual bar codes for tubes that are not labeled with physical bar codes. The nomenclature of the bar code is: “**_Position number_Unique batch ID**” (e.g., _01_1000031). Positions that are not included in the run can be deleted using the **Clear** button.

If your software is configured in such a way that virtual bar codes are generated and assigned to sample tubes that are not bar code labeled, you do not need to take further action.

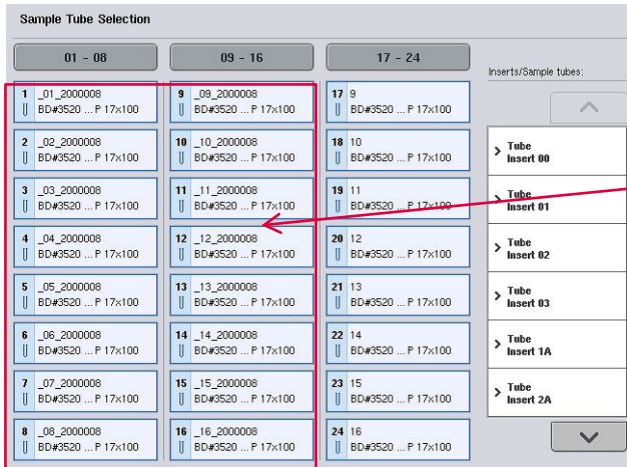

Sample tubes without
bar code labels in
position 1-16

9.3 Defining a batch/run (queuing)

9.3.1 Samples loaded in the tube carrier

Assigning different Assay Control Sets to a sample batch

To assign samples to a batch, follow the steps in sections “Without work list” or “With work list”, below.

Without work list

1. After loading a tube carrier, press the **SP Batch** button



2. Enter or change Sample IDs or labware if necessary. Press **Next** when done.
3. Select the samples that should be processed with a particular Assay Control Set by pressing the position buttons.
4. Select the application in the **Application/ACS** list that the Assay Control Set appears in. The list shows all available Assay Control Sets for the selected application.
5. Select the Assay Control Set that should be used with the selected samples.
6. As soon as the first Assay Control Set has been selected, only Assay Control Sets that can be run with that protocol are displayed.

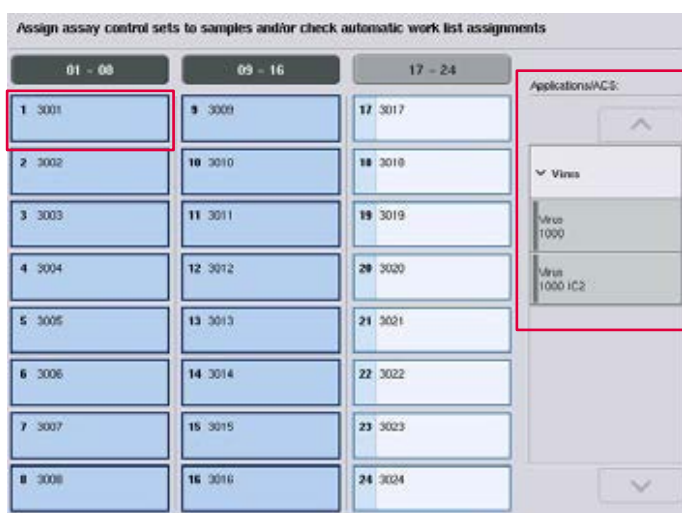

7. Repeat steps 2–5 to assign Assay Control Sets to the other samples.
Note: Only one protocol can be run within a batch of 24 samples.



8. Press **Next** to continue with the batch definition workflow.

9. Select the elution slot for the batch to be defined by pressing the corresponding slot button.

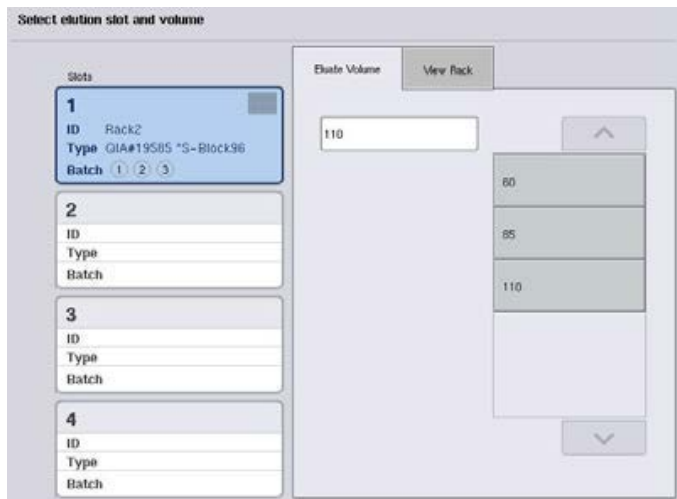

10. To overwrite the default elution volume, select the required elution volume from the list by pressing the appropriate button.

11. Press **Queue** or **Finish** to finish the batch definition workflow.

With work list

1. If all sample tubes have been correctly identified, and if there are no unidentified samples or duplicate entries (depends on the software configuration of the QIA Symphony SP), press the **Next** button to continue with the batch definition process.



2. The QIA Symphony SP checks whether there are any work list assignments for the loaded samples of the batch being defined.

3. Select the work lists that you would like to use for defining the batch. To select a work list, press its button in the list of **Available Work Lists**, then press the arrow button in the right direction. The work list will then move to the **Selected Work Lists** panel.

Note: When a work list has been selected, only work lists that are compatible with the selected work list are displayed in the list of available work lists.

Note: To deselect a work list, select it in the **Selected Work Lists** field and then press the arrow button in the left direction. The work list will then move to the **Available Work Lists** panel.

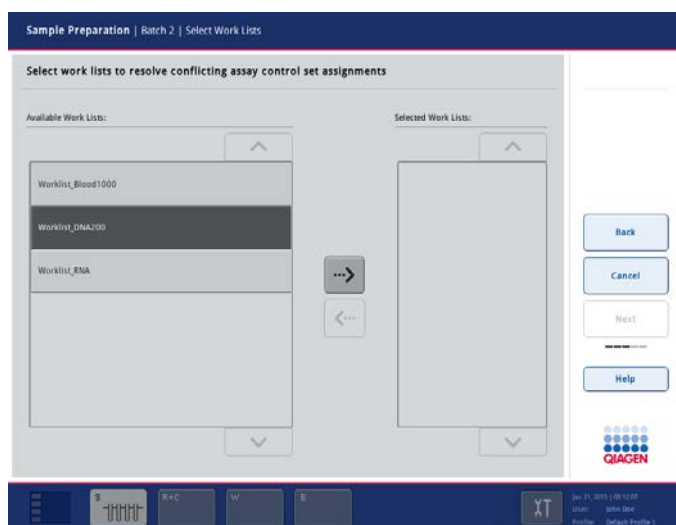

4. Press **Next** to continue.

5. For samples associated with a work list, the Assay Control Sets defined in the work list are automatically assigned. These samples display the indicator  in the lower right corner. To process any samples that are not associated with a work list, Assay Control Sets must be assigned.

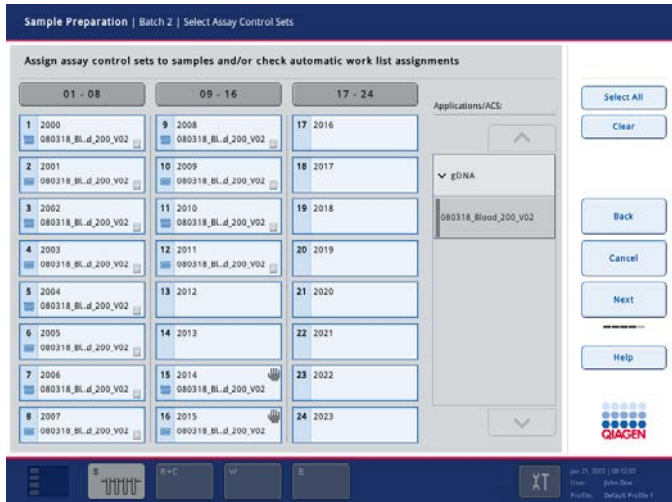

Next

6. Press **Next** to continue with the batch definition workflow.

7. Select the elution slot for the batch to be defined by pressing the corresponding slot button.

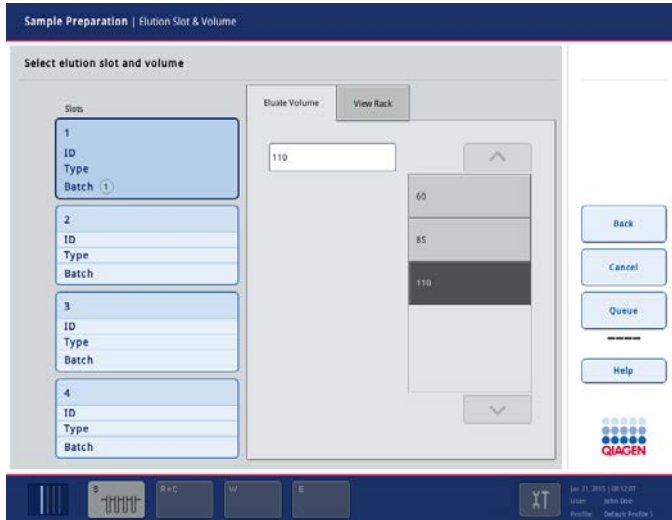

Queue

9. Press the **Queue** button to finish the batch definition workflow.

10 QIAasymphony AS Features

The QIAasymphony AS performs fully automated assay setup using a 4-channel pipetting system, and interfaces directly with the QIAasymphony SP, enabling automation of complete workflows. During assay setup, the touchscreen displays the assay setup user interface, providing information about assay runs, including their progress.

Single or multiple assays can be set up in a single assay run, and master mix can be premixed or can be prepared by the instrument. The QIAasymphony AS is provided with predefined protocols, specifically designed for use with QIAGEN real-time and end-point PCR kits. These protocols are called Assay Definitions. Assay Parameter Sets define the parameters for a protocol. These files, including other QIAasymphony AS files (e.g., cycler files, result files), can be transferred to/from QIAasymphony SP/AS instruments via the USB ports on the QIAasymphony SP.

When an assay run has been defined, the software automatically calculates the worktable requirements for a defined run (e.g., number and type of filter-tips, volume of reagent). An automated inventory scan (performed when the drawers are closed or before an assay run starts) ensures that each drawer is correctly set up for the defined assay run. It is possible to reload filter-tips during a run.

There are 2 modes of system operation to suit your workflow requirements — independent and integrated. For detailed information, see Sections 12.1.1 and 12.1.2.

Refer to the instructions for the transfer module in Section 8.3.3.

10.1 QIAasymphony AS principle

An assay setup run using the QIAasymphony AS usually consists of 3 main steps — master mix preparation, master mix distribution, and transfer of templates (e.g., samples, assay controls, and assay standards).

1. Master mix is prepared with the required reagents. The volume of each master mix component depends on the number of reactions to be set up. After preparation, a mixing step is performed to ensure that the master mix is homogeneous.

Note: If using ready-to-use master mix, the mixing step will not be performed. If the extracted samples already contain internal control, a master mix must be provided for assay controls and assay standards that contain internal control as well as for samples without internal control.

2. Master mix is distributed to the appropriate plate/tube positions in the "Assays" drawer.
3. Assay controls, assay standards, and samples are transferred to the appropriate plate/tube positions in the "Assays" drawer.

10.2 Instrument features



- | | | | |
|---|-------------------------------------|---|------------------------------|
| 1 | Input adapters (transfer positions) | 5 | Tip waste |
| 2 | Input adapters | 6 | "Eluate and Reagents" drawer |
| 3 | PCR output adapters | 7 | "Assays" drawer |
| 4 | Disposable tips | 8 | Robotic arm |

10.2.1 QIASymphony AS hood

During an assay run, the QIASymphony AS hood is locked. If force is used to open the hood during an assay run, the run will be paused.

Note: If the QIASymphony AS hood is opened, the instrument will not immediately stop. The instrument will stop when processing of the current protocol step is finished. In some cases, this may take some time.

10.2.2 QIASymphony status LEDs

LEDs at the front of the QIASymphony AS are illuminated when an assay run is in progress. The status LEDs flash when an assay run is finished or if an error occurs. Touching the screen turns off the flashing.

10.2.3 Robotic arm

This feature is the same as for the QIASymphony SP, except it does not support a robotic gripper. The QIASymphony AS pipettor head can dispense 2–1500 μ l (application- and liquid-dependent). As part of the inventory scan on the “Eluate and Reagents” and “Assays” drawers, the 2D bar code camera on the robotic arm identifies occupied/empty slots and the corresponding adapter types.

11 QIASymphony AS Drawers

11.1 “Eluate and Reagents” drawer

Purified nucleic acids can be transferred to the “Eluate and Reagents” drawer from the “Eluate” drawer of the QIASymphony SP by automatic transfer (via the transfer module) or by manual transfer. The “Eluate and Reagents” drawer has 3 positions — slots 1, 2, and 3 — that have options for cooling and can accommodate plates and tubes in special adapters. Slots 1 and 2 can be used to accommodate sample racks and slots 1 and 3 can be used to accommodate reagent racks. Slot 1 can be defined as a sample or reagent slot as required. In addition, there are 6 positions that can be used to accommodate disposable filter-tips in tip racks.

Adapters are available for the following types of consumables:

- 96-well plates
- Microplates
- Sarstedt screw-cap tubes
- PCR plates
- Snap cap microtubes
- Elution Microtubes CL (cat. no. 19588)

For more information about the types of 96-well plates and tubes that can be used in the “Eluate and Reagents” drawer, and the corresponding names used in the software, visit www.qiagen.com/goto/QIASymphony.

Reagent holders are available for holding reagents in 2 ml tubes, 5 ml tubes, and 30 ml bottles:

- Reagent holder 1 (18 x 2 ml tubes, 6 x 5 ml tubes)
- Reagent holder 2 (18 x 2 ml tubes, 2 x 5 ml tubes, 2 x 30 ml bottles)
- Micro Tube Screw Cap QS (24 x 2 ml tubes)

11.1.1 Filter-tips

The QIASymphony AS uses the same disposable filter-tips as the QIASymphony SP. In addition to 200 µl and 1500 µl filter-tips, the QIASymphony AS also uses 50 µl filter-tips. Tip racks containing 50 µl filter-tips are gray.

Note: Only use filter-tips designed for use with QIASymphony SP/AS instruments.

11.2 “Assays” drawer

Assays are set up in plates or tubes in the “Assays” drawer. The “Assays” drawer has 3 positions — slots 4, 5 and 6 — that can be cooled and used to accommodate assay racks in special adapters. It also has 6 positions that can be used to accommodate disposable filter-tips in tip racks (see Section 11.1.1 for more information about disposable filter-tips).

Note: For subsequent analysis on the Rotor-Gene® Q, assays can also be set up in Rotor-Discs. In this case, slots 4–6 must be covered with the Rotor-Disc® Adapter Base Unit QS and up to 2 Rotor-Disc 72 Loading Blocks. A Rotor-Disc 72 can then be placed onto each Rotor-Disc 72 Loading Block.

Note: Assays that include a normalization step can use slot 6 for positioning a normalization rack (and, if needed, slot 4 can be added for a two-step dilution). In cases where a normalization rack is needed, slot 6 (and potentially slot 4) cannot be used for an assay rack.

Note: Do not mix reagents from different lots; such mixing cannot be tracked by QIAasymphony SP/AS.

Adapters are available for the following types of consumables:

- 96-well PCR plates
- Rotor-Gene Strip Tubes
- Rotor-Disc 72
- Glass capillaries (20 µl) (for use with the LightCycler®)

For more information about the types of plates and tubes that can be used in the “Assays” drawer and the corresponding names used in the software, visit www.qiagen.com/goto/QIAasymphony.

12 QIASymphony AS Basic Functions

12.1 Definitions

12.1.1 Independent operation

The QIASymphony SP and QIASymphony AS can be operated independently of each other. It is possible to perform 2 independent runs (one on the QIASymphony SP and one on the QIASymphony AS) at the same time, where neither run influences the other.

It is also possible to perform an independent run on the QIASymphony SP, and then transfer eluates via the transfer module to the QIASymphony AS. Here, samples can be processed using an independent assay setup run. In this case, sample preparation run definition must be performed first, and when the eluate rack is transferred to the QIASymphony AS, assay setup run definition is performed.



Independent operation.

12.1.2 Integrated operation

An integrated run consists of a sample preparation run on the QIAasymphony SP and then an assay setup run on the QIAasymphony AS. Eluates are automatically transferred from the QIAasymphony SP to the QIAasymphony AS via the transfer module without user interaction. An integrated run is defined in the software for the complete workflow before starting the run.



Integrated operation.

12.1.3 Run with normalization

The QIAasymphony AS can perform a one-step and a two-step normalization (i.e., eluates of known concentration are diluted to target concentrations) before assay setup. For the normalization, the concentration data file can be generated with the **Concentration Data Editor** in the QIAasymphony Management Console (QMC). See Section 7 of the *QIAasymphony Management Console User Manual* for more details.

If a two-step normalization is necessary, an additional previous predilution step is performed. This option is available for most assay definitions in combination with a normalization definition file, which is available on request from the QIAGEN Applications Laboratory. Please contact QIAGEN Technical Services for more information.

Note: During the normalization process the dilution is set up on one or two normalization rack(s). Since QIA Symphony also creates rack file(s) for the normalization rack(s), the user can use the normalization rack like an ordinary eluate rack and reuse it to define a subsequent run.

12.1.4 Standard curve

The QIA Symphony AS can perform series dilutions of standards, using concentrated standard solution and dilution buffer, both provided by the user. This feature is only available when defined by an assay. This option can be enabled on request by the QIAGEN Applications Laboratory. Please contact QIAGEN Technical Services for more information.

12.2 Preparing a run

Before defining a run, available adapter(s) and holder(s) must be configured in the software. If work list(s) and rack file(s) will be used in the run, these files must be transferred to QIA Symphony SP/AS instruments.

For detailed information about transferring process files, work lists, rack files, and concentrations data files, see Section 6.

12.2.1 Assay favorites

In the integrated mode, personalized assay favorites can be defined for quicker assignment within the setup screen for **Integrated Operation**.



1. Press the **Tools** tab and select **Assay Favorites**.

The **Define Assay Favorites** screen appears as shown below.

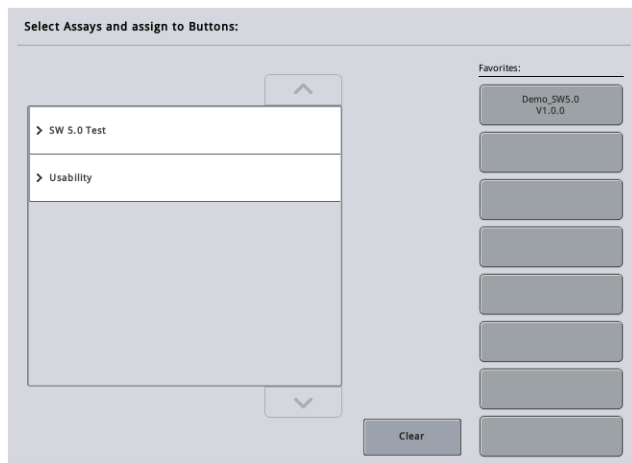

The dialog contains a list showing the available assays for **Integrated Setup** and the set of favorite buttons identical to the ones in the **Integrated Setup** screen.

2. Select the assay to assign as a favorite.

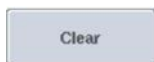

3. Assign the selected assay to a selected blank **Favorites** button.

The assay will be displayed on the assigned favorite button.

4. Press **Save**.

Changes are saved in the user data, enabling user-specific configuration of the **Favorites** buttons.

5. To remove assays as favorites, select the button and then press **Clear**.

The selected assay will be removed from the **Assay Favorites**.

6. If **Cancel** is pressed, a message appears warning that all changes will be lost.

12.3 Integrated run

Follow the steps below after switching on the instrument and logging in as a user.

1. Load all items of the QIAAsymphony SP/AS removed previously during maintenance, if not already done (e.g., tip chutes, drop catcher, magnetic-head guards, tip disposal bags, empty waste bottle and tip park station). Close the QIAAsymphony SP/AS hoods.
2. Switch to the **Integrated Run** user interface.
3. Load the QIAAsymphony SP "Waste drawer".
4. Load the "Eluate" drawer with the correct rack inside the corresponding cooling adapter, together with the transfer frame on "Elution slot 1". Assign the eluate rack to "Elution slot 1" on the touchscreen and start the scan.
5. Load the "Reagent and Consumables" drawer for sample preparation according to the handbook of the kit used.
6. Press **Define Run** to define an integrated run on the QIAAsymphony SP/AS.
7. Load the "Sample" drawer with samples and optionally with internal controls.
8. Press **Edit Samples** to check or change sample tube types and inserts. The default tubes are predefined for the inserts in the configuration and can be changed.
9. Press **Define Assays** to assign assays to sample positions, or use the previously defined **Assay Favorites** buttons to assign assays to the sample positions.
10. Create AS batch(es) using the defined SP batch(es)

11. Queue the integrated run by pressing **OK**.
12. **Optional:** Define internal control(s).
13. Start the integrated run by pressing **Run**.
14. While the integrated run is being processed on the QIASymphony SP, load the QIASymphony AS. Open the "Eluate and Reagents" and "Assays" drawers.
15. Load assay rack(s) into the appropriate precooled adapter(s) and place them onto the "Assay" slot(s).
16. Press the orange **Assay Rack** button, and press **Load** in the next screen to load the assay racks(s) virtually.
17. Fill each reagent tube with the required volume of appropriate reagent and place the reagent tubes, without lids, into the appropriate positions of precooled adapters for reagents.
18. Press the orange **Reagent Rack** button, and press **Load** in the next screen to load the reagent rack(s) virtually.
19. Place the prepared assay adapter(s) onto the appropriate slot(s).
Note: Ensure that reagents are completely thawed. Enter a kit bar code for each QIAGEN assay kit used.
20. Load disposable filter-tips into the "Eluate and Reagents" and "Assays" drawers. Load at least the required number of each tip type.
21. Close the "Eluate and Reagents" and "Assays" drawers and start the inventory scan.
22. Assay setup will start automatically after the inventory scan was performed successfully and the sample preparation for the integrated batch was finished.
23. When running more than one integrated batch, remove the previously finished integrated batch in the **Integrated Setup** overview. Reload the QIASymphony AS "Eluate and Reagents" and "Assays" drawers to continue the next AS batch.

12.3.1 Defining an integrated run

When defining an integrated run, screens guiding you through the steps appear on the touchscreen.

It is only possible to define an integrated run if an eluate rack and a transfer frame have been loaded on "Eluate slot 1" of the QIASymphony SP. To save time, the system checks for the transfer frame during the rack carrier inventory scan.

Select the **Integrated Run** tab in the overview screen, and then press **Define Run**.

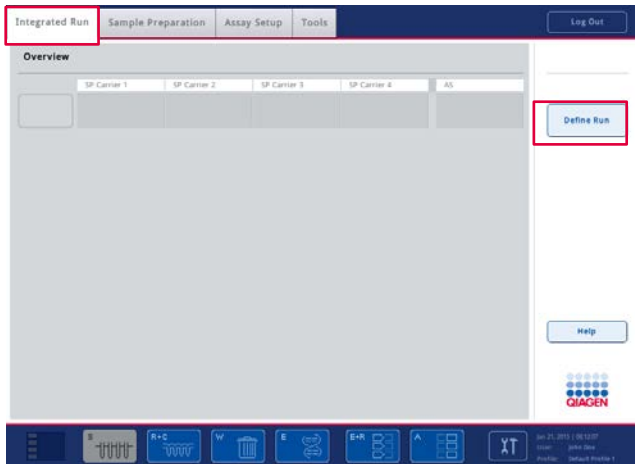

The **Integrated Setup** screen appears.

If an error message appears, see Section 13 for information about solving the problem.

The **Integrated Setup** screen provides an overview of the defined batches and/or allows batches to be defined.

To define a batch, follow the steps below.

1. Select the batch button. Edit samples (this includes resolving errors in the sample IDs of the sample tubes).
2. Assign an assay to all samples of a batch.
3. Define assays for a batch.
4. Create or remove AS batches from their related SP batch.

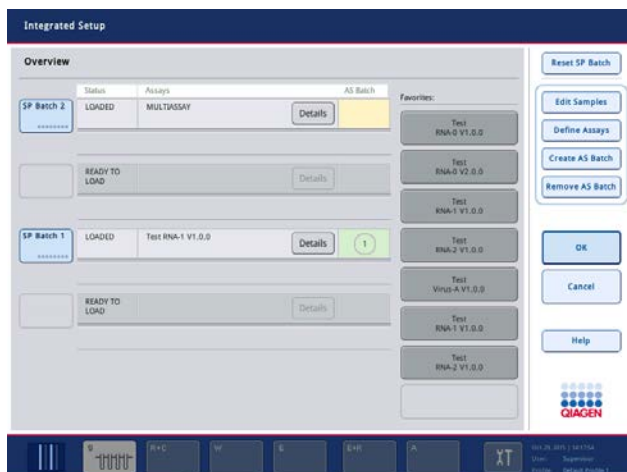

An integrated run consists of one or more integrated batches. An integrated batch is a combination of one or more SP batches and one AS batch. Hence, the eluates of several SP batches can be processed in one AS batch.

Assigning assays to sample positions

Assays can be assigned to samples using:

- **Favorite** assays
- The **Assay Assignment** screen (manual assignment)
- Work lists

Favorite assays

First, you need to set up a list of **Favorite** assays (see Section 12.2.1) and then follow the steps below.

1. Select the desired SP batch(es).
2. Select the desired **Favorite** assay.

Assigning assays using the Assay Assignment screen



1. Select the SP batch.



2. Press **Define Assays** in the **Integrated Setup** screen.

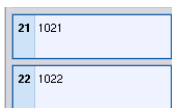

3. The **Assay Assignment** screen appears. Here, assays can be assigned to specific sample positions.

4. Select the sample positions to which the assay should be assigned.

These will be shown in light blue before selection and darker blue after selection.



5. Alternatively, select all the samples by pressing **Select All**.

6. Select the desired assay from the **Assays** list.

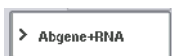

The selected assays will be assigned to the selected positions. A number will appear in the bottom right corner of the assigned sample positions. This number indicates the number of assays that have been assigned to a particular sample.

7. If there is more than one assay to be assigned, repeat steps 4 and 5 for all assays.

For each assigned assay, there is a separate tab. When an assay tab is selected, all samples with this assigned assay are colored green and have the same assay-specific number in the bottom left corner of the sample position.

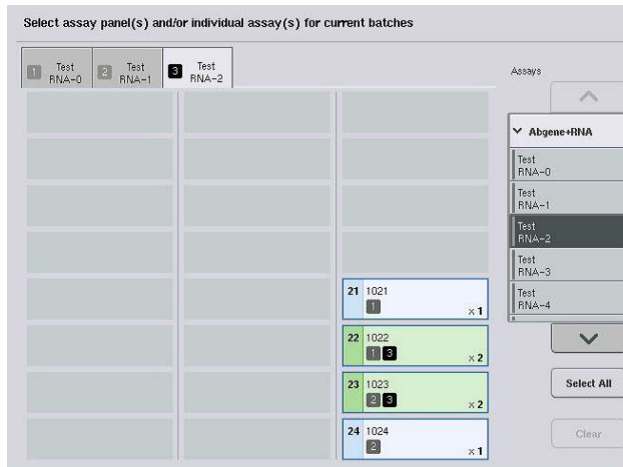

- Press **OK**. The **OK** button becomes inactive when at least one conflict exists.

Modifying assay specifications

Depending on the assay definition, it is possible to modify certain assay specifications for the run that is being defined.

Note: For "Read only" Assay Parameter Sets, it is ensured that when defining a run, only the number of replicates can be changed using the touchscreen.

Note: It is not possible to modify assays in work list mode.



- Press the **Specification** button. The **Assay Specifications** screen will appear.
- Select the assays for which the parameter will be changed from the tabs.
- Press **Yes** or **No** to define whether or not a ready-to-use master mix will be used.

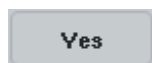

Parameters are listed under **Sample**, **Assay controls**, and **Assay standards** headings.

- Press one of these headings to view a list of parameters. To scroll through the list, use the up and down arrows.

Depending on the assay, some headings are not visible.

5. Modify the desired parameter(s).

After modifying a parameter, the hand symbol is displayed in the active assay tab. After modifying assay parameters, a hand symbol appears.

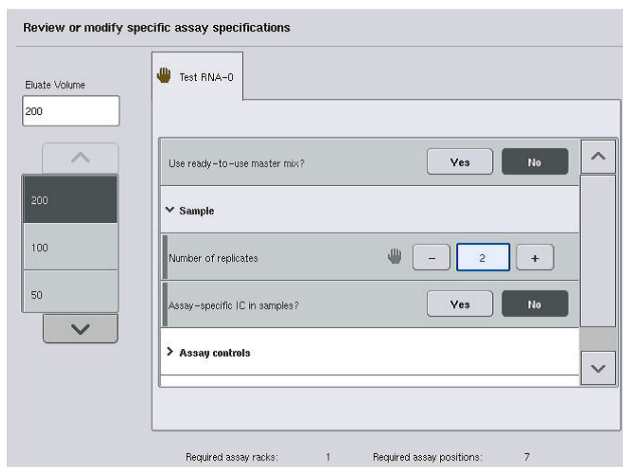

6. If the parameters for more than one assay need to be modified, repeat steps 2–5 for the other assay(s).

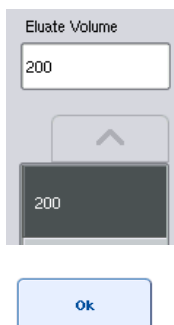

7. To overwrite the default elution volume, select the required elution volume from the **Eluate Volume** list on the left side of the screen by pressing the appropriate button.

8. Press **OK** to save the changes and to return to the **Assay Assignment** screen.

Note: If the parameters are modified, the changes will not be saved in the assays. They will be used for the current run only. To change parameters in an assay for future runs, use the **Process Definition** editor tool of the QIASymphony Management Console.

Assigning assays using work lists

If a work list(s) is used, assays are automatically assigned to samples via their written bar code(s), as defined in the work list(s). Those batches that have assays assigned to them by work lists are marked with a work list symbol in the **Assays** column (circled in the image below). Depending on the configuration, the assignments can be edited in the **Assay Assignment** screen by pressing the **Define Assays** button.

Note: If the sequence recognized in the sample carrier is not the same as the sequence of samples in the work list, a warning may appear. (For more information, see parameter “Warn, if sample sequence differs from work list entry sequence?” in Section 6.2.2 of the *QIASymphony SP/AS User Manual – General Description*).

Note: If the work list has been assigned, the Assay Control Set is automatically assigned to samples for which the sample ID matches the defined sample ID in the work list. Depending on the configuration setting, it might not be possible to change this automatic assignment.

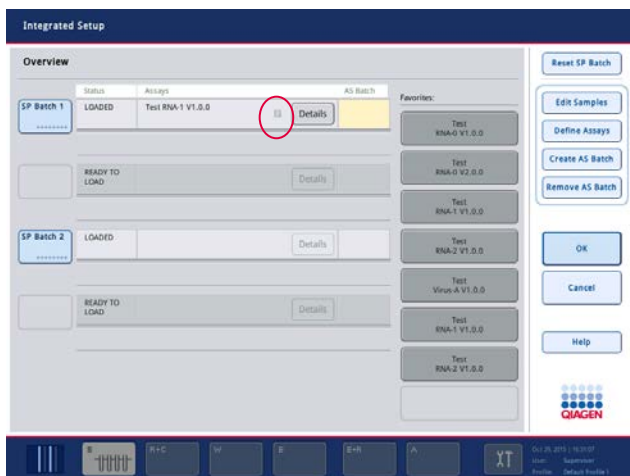

Creating AS batches

An AS batch can be created either from a single SP batch or from more than one SP batch.

To create an AS batch, follow the steps below.



1. In the integrated setup **Overview** screen, press one or more SP batches to select them.

2. When selected, the batch button(s) will change to gray.



3. Press the **Create AS Batch** button.

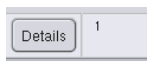

An AS batch will be created for the selected SP batches. A number will appear in the **AS Batch** column. This number indicates which AS batch a particular SP batch is linked to.

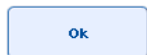

4. Press **OK**.

The created integrated batches are queued. Afterwards the **Main Screen** appears.

Note: To unlink an AS batch from an SP batch, press the SP batch(es) to select them, and then press **Remove AS Batch**.

Defining internal controls

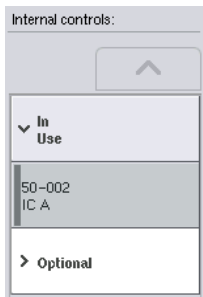
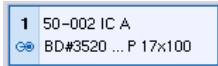

1. First load the internal controls into "Slot A" of the "Sample" drawer.
2. Press the **IC** button in the **Integrated Run** tab. The **Sample Preparation/Internal Controls** screen appears.
3. Press the loaded internal control(s) to select them.
4. If the tube type differs from the default, press the **IC Tubes** button, and select a tube type.
5. Select an internal control from the **Internal controls** list. The selected internal control will be assigned to the selected loaded internal control(s).
6. Press **OK**.
The selected internal controls will be assigned to the selected internal control tubes. The **Integrated Run Overview** screen appears again.

Starting an integrated run

1. Load the QIAasympy SP worktable.
2. Start the integrated run by pressing **Run**.
3. While the integrated run is being processed, load the QIAasympy AS worktable.

Modifying an integrated run

If an integrated run has already been defined, the **Integrated Run** screen displays the status of all defined integrated batches and the relationship between SP and AS batches.

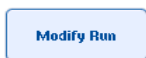
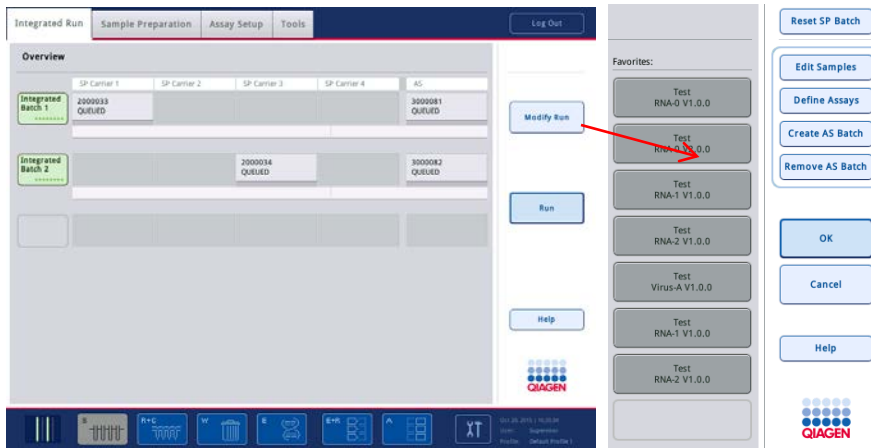

1. Press **Modify Run**. The **Integrated Setup** screen appears and displays an overview of the defined batches.



2. Use the **Remove AS Batch** button to remove an AS batch from the integrated run of the related SP batch.

This button is unavailable if the AS batch has been started.



3. The **Edit Samples** button allows bar code reading errors for sample tubes to be resolved. In addition, sample IDs, sample types, and sample labware can be modified.

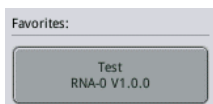

4. Assign the assay to all samples of a batch via the favorite buttons.



5. Define assays for a batch.



6. Use the **Create AS Batch** button to assign an AS batch to one or more SP batches.

Note: It is possible to change the order in which batches of an integrated run are processed by manually unloading, reloading, and redefining an integrated batch.

Note: Be aware that if you use the functions **Modify Run** and **Create AS Batch** after an integrated run has been queued, the order in which SP and AS batches are processed by the system may be different to the order in which batches would be processed if AS batches were created before queuing the integrated run.

For more detailed information, refer to Appendix A of the *QIAAsymphony SP/AS User Manual – Operating the QIAAsymphony AS*.

Note: At least one assay has to be assigned to samples of the QIAasymphony SP batch.

Note: This action can also be performed for completed QIAasymphony SP batches, allowing automated assay setup of samples for which purification has already been completed.

12.3.2 Loading an integrated run

First, load the QIAasymphony SP. Then load the QIAasymphony AS.

Optional: Load the QIAasymphony AS while the QIAasymphony SP is running.

This section outlines how to load samples, reagents, and consumables onto the QIAasymphony AS.

In addition, the **Loading Information** screen provides an overview of which labware, consumables, and adapters are required for a run. The number and type of filter-tips that are required is displayed. Press a particular slot for more detailed information.

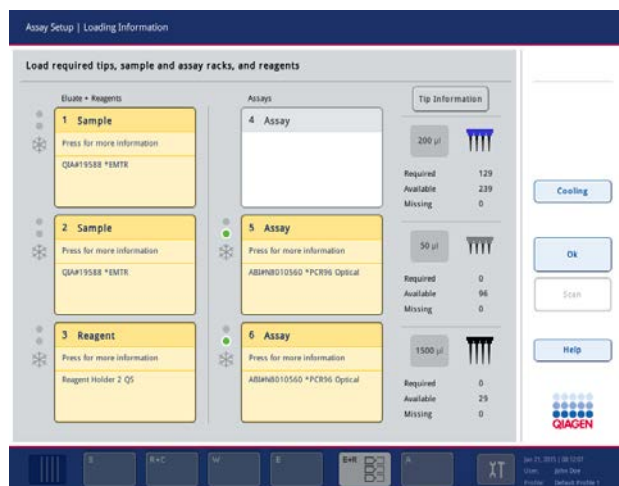

Loading sample racks

Sample slots

Press a sample slot for detailed loading information. A schematic diagram of the sample rack appears.

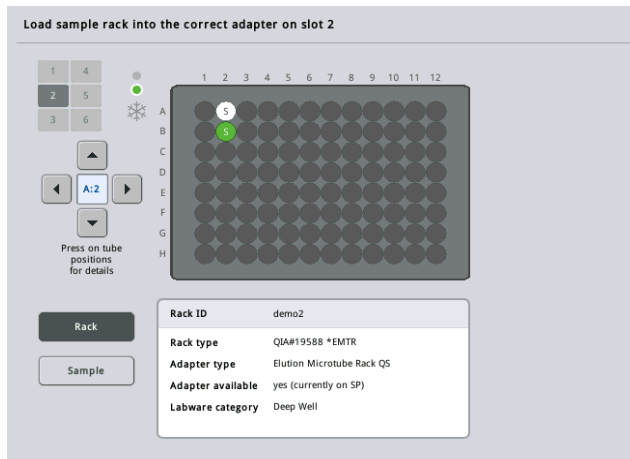

Press an individual position to view information about a particular sample. You can also use the arrows to select a position. When **Sample** is pressed, the sample ID, sample type, status, and sample volume are displayed, as well as the assay to which this sample has been assigned.

To view information about all of the samples in the sample rack in tabular format, press **List View**.

Note: The sample rack is transferred from the QIAAsymphony SP to the QIAAsymphony AS. Therefore, the sample rack does not need to be loaded onto the QIAAsymphony AS for an integrated run.

Loading assay rack(s)

“Assay” slots

Press an assay slot for detailed loading information. A schematic diagram of the assay rack appears.

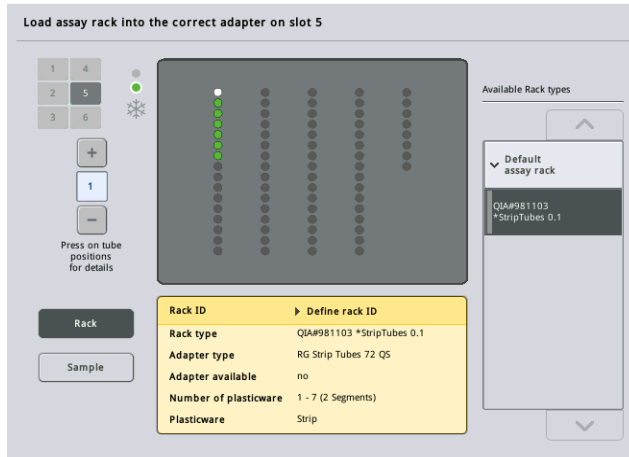

Press an individual position to view information about the sample at that position. You can also use the arrows to select a position. When **Sample** is pressed, the sample ID, sample type, status, and volume are displayed, as well as the assay to which this sample has been assigned.

To view information about all of the positions in the assay rack in tabular format, press **List View**.

Assay racks

The required number of assay rack(s) is calculated by the software. The maximum number of assay racks is 3. If an assay run includes a normalization step, up to 2 assay racks can be used. If a two-step dilution is used, depending on the number of samples, 2 normalization positions may be required (slot 4 and slot 6). If a Rotor-Disc is used as an assay rack, slots 4–6 are covered by the Rotor-Disc Adapter Base Unit QS. A maximum of 2 Rotor-Discs can be used.

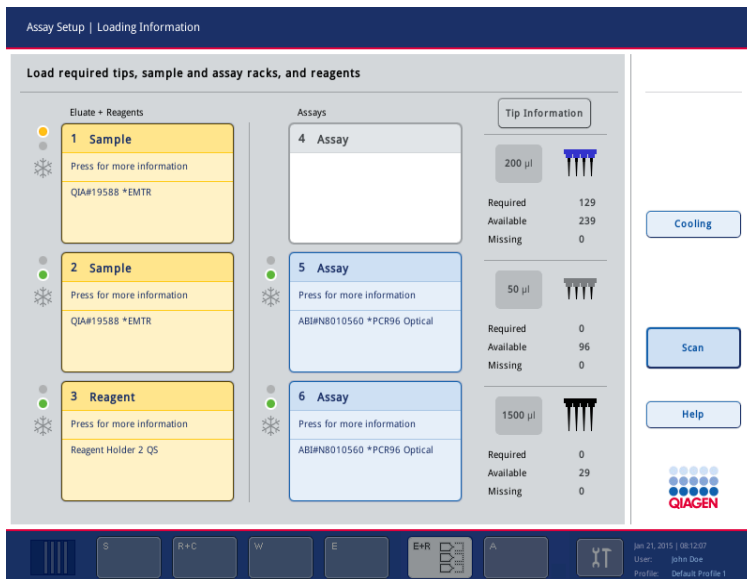

Loading information screen with assay racks assigned to slot 5 and 6.

“Assay” slots are assigned automatically by the software, the assignment cannot be changed by the user. The assignment depends on the processing workflow. Slot 5 is processed first, then slot 6, and then finally slot 4.

Assigning assay racks

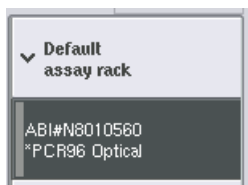
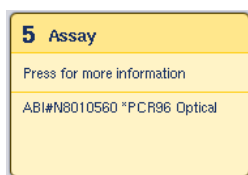

1. Open the “Assays” drawer. Temporary cooling for the defined slots is started.
2. In the **Assay Setup/Loading information** screen, press the first “Assay” slot to be loaded (highlighted yellow). Detailed loading, information for the slot is shown
3. Assign rack type and rack ID.
For details, see this section “Assigning assay racks” or the following section “Assigning assay rack types”.
4. Place the empty assay rack in the appropriate adapter on the correct “Assay” slot(s).
Ensure that the appropriate adapter is used with each assay rack.
5. Press **Load**. The **Assay Setup/Loading information** screen appears again. The loaded slot is now blue.

6. If more assay racks have to be loaded, repeat steps 2–5 for the second assay slot.

7. Leave the "Assays" drawer open to enable loading of normalization rack (optional) and disposable filter-tips.

Note: When using segmented labware, the required plasticware and corresponding positions will be displayed. Ensure that the correct positions are used. The positions will not be checked during the inventory scan.

Assigning assay rack types

A default assay rack type is defined in each Assay Parameter Set. This default assay rack type is automatically displayed in the "Assay" slots in the **Assay Rack(s)** screen. For some assay rack types, the assay rack can only be changed to an assay rack that uses the same adapter type. If Assay Parameter Sets have been assigned that have different default rack types, no rack type will be specified in the corresponding assay slot. All rack types that are specified in one or more of the assays are listed under **Default**, and all other assay racks that can be used are listed under **Other**.

To change the assay rack type or to assign an assay rack type, follow the steps below.

1. Select a rack type from those listed on the right. The up and down buttons can be used to scroll through the list.

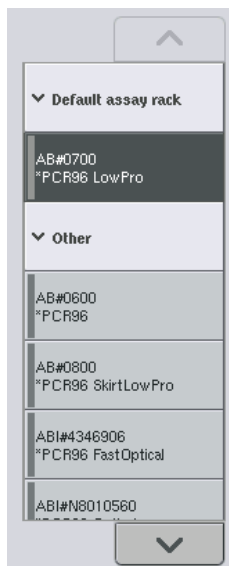

2. The assigned rack type is then displayed in the selected "Assay" slot.

Note: The list only displays rack types that have the same assay rack format.

Assigning assay rack ID(s)

The assigned assay rack ID will be used to create a rack file. The name of the rack file is **RackFile_rack ID**.

Note: Be aware that some symbols may not be used in the rack file name and some symbols will be converted.

Note: If the assay rack type is changed after a rack ID has been entered, the rack ID will remain the same.

To assign rack IDs, follow the steps below.

1. Press **Rack ID**. The **Manual Input** screen appears.
2. Manually enter an assay rack ID. Alternatively, use the bar code scanner to enter a rack ID.

Rack ID

The entered assay rack ID will appear in the corresponding "Assay" slot. If a rack type has already been assigned to the "Assay" slot, the slot will now appear blue.

3. Optional: Press the **Automatic ID** button. The software will automatically assign an ID with the format **SlotNr_RunID_Suffix** (e.g., S5_1000017_0000).

Automatic ID

A rack ID is automatically assigned to the selected "Assay" slot(s). If a rack type has been assigned to the "Assay" slot(s), the slot(s) will now appear blue.

Note: When using a Rotor-Disc, place the Rotor Disc onto the Rotor Disc adapter, the adapter onto the Rotor Disc Adapter Base Unit QS, and the base unit onto slot positions 4, 5, and 6.



Loading reagent slots

Note: Ensure that the correct labware is used. Use of labware that is different to that defined in the **Loading Information** screen may result in an error during preparation or transfer of the master mix. This could result in damage to the QIA Symphony AS.

To load a reagent adapter with reagents, follow the steps below.

1. Open the “Eluate and Reagents” drawer.
2. In the **Assay Setup/Loading information** screen, press the first “Reagents” slot (shown in yellow). The detailed loading information for the slot is shown.

Assay Setup | Loading Information

Load required tips, sample and assay racks, and reagents

Eluate + Reagents

- 1 Sample**
Press for more information
QIA#19588 *EMTR
- 2 Sample**
Press for more information
QIA#19588 *EMTR
- 3 Reagent**
Press for more information
Reagent Holder 2 QS

Assays

- 4 Assay**
Press for more information
- 5 Assay**
Press for more information
ABIN8010560 *PCR96 Optical
- 6 Assay**
Press for more information
ABIN8010560 *PCR96 Optical

Tip Information

Volume	Required	Available	Missing
200 µl	129	239	0
50 µl	0	96	0
1500 µl	0	29	0

Cooling

Scan

Help

QIAGEN

Jan 21, 2015 | 08:12:07
User: john.doe
Profile: Default Profile 1

3. Place the appropriate precooled reagent adapter onto the defined “Reagent” slot.
4. Press the “Reagent” slot(s) to view detailed information about the required reagents, tubes, and corresponding volumes. The **Loading Reagents** screen appears.

A schematic of the reagent adapter that will be used is displayed on the screen.

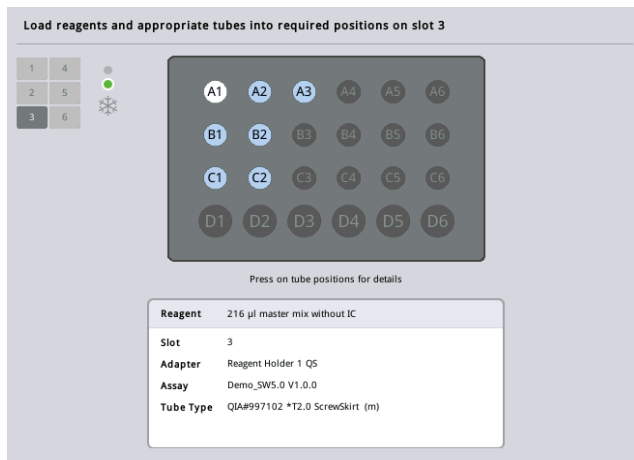

5. Press an individual position to view loading information for that particular position.

The position will change from blue to white and detailed information about the reagent, tube type, and volume for that position on the adapter will be displayed in the table.



6. To view loading information about all reagents for a particular assay, press **List View**.

7. Select different assay tabs to see reagent information for the different assays. To view reagents for all assay(s) defined for the run, select **All Reagents**.

If ready-to-use master mix was selected for an Assay Parameter Set, the list contains information about the composition of the master mix, as shown in the screenshot below.

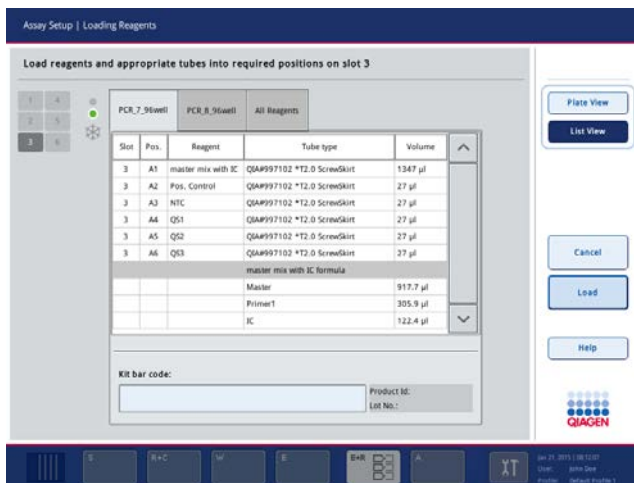

8. Load the required reagents and empty tubes in the defined positions.



9. Press **Load**. The **Assay Setup/Loading information** screen appears again. The loaded slot is now shown in blue.

See procedures “Entering reagent kit bar codes” and “Defining customized kit bar codes” below.

Entering reagent kit bar codes

To enter a reagent kit bar code for each assay, follow the steps below.

1. Switch to **List View**, or press the **Scan Kit Bar Code** button.

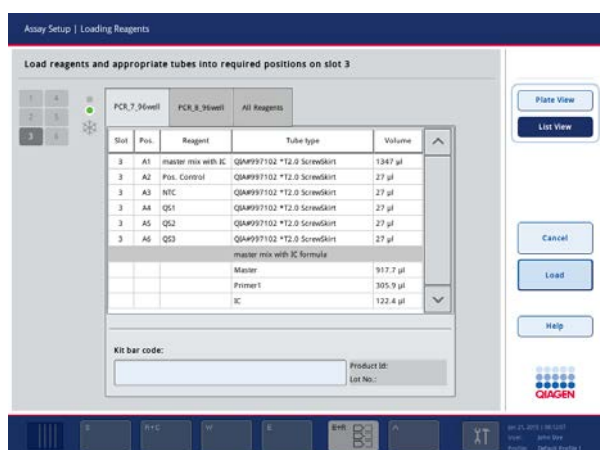

2. Press the appropriate tab to select an assay.

3. Press the **Kit bar code** field.

4. Manually enter the bar code, or enter a bar code using the bar code scanner.

5. Press **OK** to return to the **Loading Reagents** screen. If the bar code scanner was used, the **Loading Reagents** screen will automatically reappear.

6. The software validates the kit bar code of known format and checks the lot number and expiration date.

Note: Multiple kit bar codes for one assay must be separated by a semi colon. In this case, validation of lot number and expiration date will not be performed.

Note: For QIAGEN assays, do not mix different lot numbers within one run.

Note: Entered kit bar codes, including additional information (i.e., expiration date, product number and lot number), are tracked in the result file.

Note: If the entered kit bar code does not follow a recognized format, a message will appear, asking whether to accept the bar code. Press **OK** to continue.

Defining customized kit bar codes



It is possible to use customized kit bar codes. Validation of the lot number and expiration date is performed by QIAasymphony SP/AS instruments and is tracked in the result file. The bar code must have the following format (e.g., *123456;20151231).

*	Start delimiter
n x	Lot number
;	Delimiter
yyymm	Expiration date

It is possible to use other kit bar codes. After entering the bar code, validation of the lot number and expiration date is not performed. The bar code is tracked in the result file.

Loading disposable filter-tips

Up to 6 tip racks can be placed in the “Eluate and Reagents” drawer and the “Assays” drawer (i.e., a total of 12 tip racks). Tip rack position, tip type, and number of tips are detected during the inventory scan. The number of tips required varies depending on the assay(s) being run.

Tip Information	
200 µl	
Required	129
Available	239
Missing	0
50 µl	
Required	0
Available	96
Missing	0
1500 µl	
Required	0
Available	29
Missing	0

Three different types of disposable filter-tips can be used on the QIAasymphony AS — 50 µl, 200 µl, and 1500 µl. Tip information is displayed on the right side of the **Loading Information** screen. For each tip type, the number of required, available, and missing tips is listed.

We recommend that you load more tips than the actual number of required tips calculated by the software. This is because filter-tip consumption can be affected by some processes on the QIAasymphony AS (e.g., liquid-level detection). In addition, we recommend to load tips preferably in the rear tip rack slots. For more information about tip loading, press the **Tip Information** button.

Note: The number of individual tips is displayed, and not the number of tip racks.

Note: The number of available tips is calculated by the software based on the previous run and inventory scan. If the number of available tips does not correspond with the number of required tips, a message will appear during the inventory scan.

To load a disposable filter-tip rack, follow the steps below.

1. If not already open, open the “Eluate and Reagents” and/or the “Assays” drawer.
2. Hold the tip rack with 2 fingers, using the grips.
3. Gently squeeze the tip rack and place it into a tip rack slot.

Note: Ensure that the tip racks are properly seated in the tip rack slot so that the tip racks will be identified during the inventory scan.

12.3.3 Checking cooling temperatures (optional)

Cooling temperatures are shown in an overview screen.

Press the **Cooling** button in the **Loading information** screen. The **Temperature Status** screen appears.

The QIAsymphony AS automatically starts cooling after the adapters have been loaded virtually on the touchscreen. The current temperature of the cooling positions is updated in real time. If the current temperature is outside the target temperature, the slot will appear yellow. If the current temperature is within the target temperature the slot will appear green.

The target temperature is defined in the assay definition and cannot be changed using the touchscreen.

The cooling settings for “Sample”, “Reagents” and “Assay” slots can be switched on, if the rack is not yet loaded (precooling).

Note: The temperature of the cooling positions throughout an assay run is documented in the result file.

To switch cooling on, follow the steps below.

1. Press the snowflake button to the left of the cooling position to be switched on.
Cooling for that position will be switched on, and the slot will appear black.



- To switch cooling off again, press the snowflake button to the left of the cooling position to be switched off.

The snowflake button will appear gray.

Note: When a Rotor-Disc is assigned as an assay rack, slots 4–6 are covered with the Rotor-Disc Adapter Base Unit QS. Therefore, only one snowflake button is necessary and visible for slots 4–6.

Note: If a rack is loaded, cooling cannot be switched off.

12.3.4 Starting an integrated run

- Press **Run** in the **Integrated Run** screen.

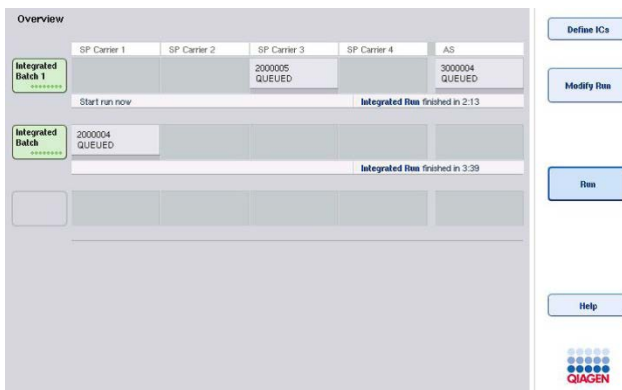

- The status of an integrated run can be viewed in the **Integrated Run View** screen.

12.3.5 Removing assays after an AS run

When an assay run is completed or canceled, the assays must be removed from the “Assays” drawer. The assays will not be automatically removed from the QIASymphony AS.

If the status of a run is shown as **QUEUED**, **STOPPED**, or **COMPLETED**, the assay rack(s) and adapter(s) can be removed.

1. Press the batch button of a completed integrated batch in the **Integrated Run Overview** screen.



The following message appears.

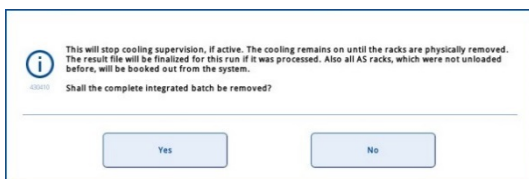

Press **Yes** to remove the batch.



Note: The racks should now be removed, since cooling supervision is switched off for all slots. Actually, the cooling will remain active until the racks are physically unloaded, but temperature errors cannot be recognized.

2. Open the “Assays” drawer and the “Eluate and Reagents” drawer. The **Assay Setup/Loading Information** screen appears.
3. Physically remove all racks, including the assay rack(s).
4. Close the “Assays” and the “Eluate and Reagents” drawers.

5. In the **Assay Setup/Loading Information** screen, press **Cancel**. The **Overview** screen is opened.



If more QIASymphony AS runs are to be performed, proceed with loading the next QIASymphony AS run.

Note: The loading instructions for the next QIASymphony AS run are already displayed. It is possible but not necessary to proceed with loading the next batch now.

Note: In integrated mode, the sample rack staying in the QIASymphony SP cannot be removed in this step.

12.3.6 Procedure after run completion

After the inventory scan is performed and the **Assay Setup/Loading Information** screen appears again, follow the steps below.

1. Remove the eluate rack(s), including adapter(s), from the “Eluate” drawer of the QIASymphony SP.
2. Remove the reagent tube(s) and bottles, including adapter(s).
3. Replace the tip disposal bag after each run.

12.3.7 Pausing, resuming, and stopping an integrated run

Pausing a QIASymphony SP or a QIASymphony AS run

A run on the QIASymphony SP or the QIASymphony AS can be paused by pressing the **Pause SP** or **Pause AS** button in the **Integrated Run** screen. If a QIASymphony SP or a QIASymphony AS run is paused, the pipetting step is completed before the run pauses.

The screen below is displayed when the **Pause SP** or **Pause AS** button is pressed.

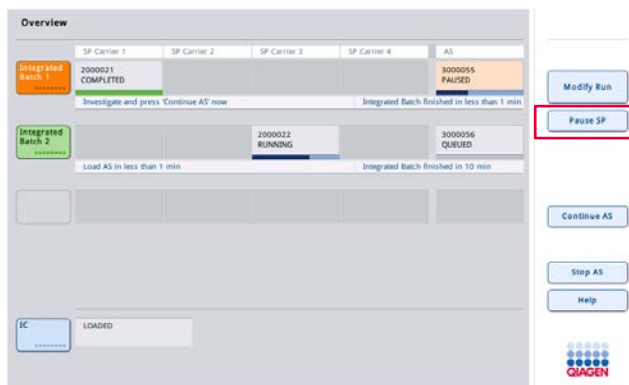

If the run is paused, two options are available: the run can be resumed or stopped.

Note: Pausing a run interrupts the sample preparation or assay setup procedure and may affect the performance.

Note: Only pause a run in an emergency.

Note: Processed samples will be flagged as “unclear” as soon as the QIASymphony SP or QIASymphony AS is paused and the run is resumed.

Resuming a run

To resume a run, press the **Continue SP** or **Continue AS** button. Processed samples will be flagged as “unclear” as soon as the QIAasymphony SP/AS is paused and continued.

Stopping a run

If a QIAasymphony SP or QIAasymphony AS run is paused, press the **Stop SP** or **Stop AS** button to stop the integrated run. On pressing **Stop SP**, all batches currently being processed will be stopped, although AS batches previously started will be completed. On pressing **Stop AS**, all SP batches currently being processed will be completed

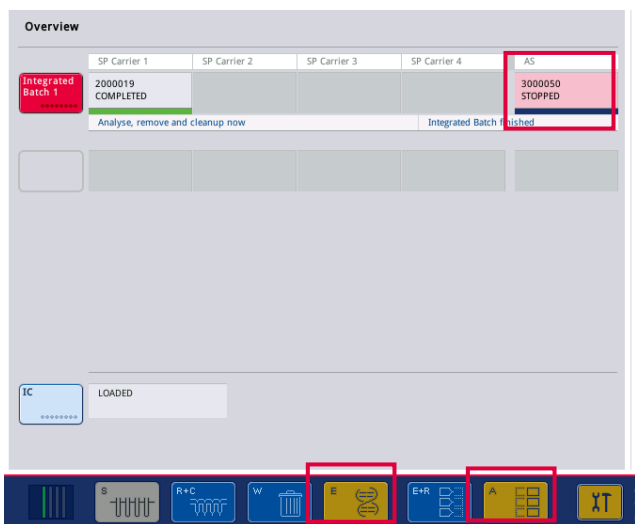

If the run is stopped, all processed samples are flagged with “invalid”. It is not possible to process these samples further.

After stopping a QIAasymphony SP or a QIAasymphony AS run, or if the run stops due to an error, the buttons of the affected drawers flash. Press the flashing button(s) to display the warning or error messages.

12.4 Independent run

12.4.1 Defining an independent assay run

To start the assay definition process, press the light blue **New** button in the assay setup **Overview** screen.

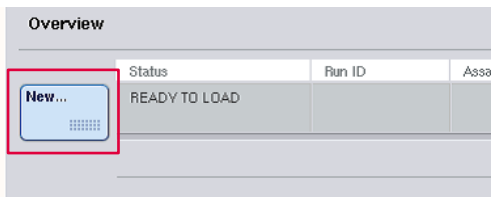

Defining “Sample” slots and assigning sample racks

By default, slot 2 is defined as a “Sample” slot. This cannot be changed. Slot 2 is automatically preselected in the **Sample Rack(s)** screen and is highlighted dark yellow.

Slot 1 is by default defined as a “Reagents” slot. If required, slot 1 can be redefined to create an additional “Sample” slot.

Each “Sample” slot must be assigned a rack type and a rack ID. If a rack file is available, a rack type and rack ID will be automatically assigned when the rack file is assigned to the “Sample” slot. If no rack file is available, the rack type and rack ID must be manually assigned.

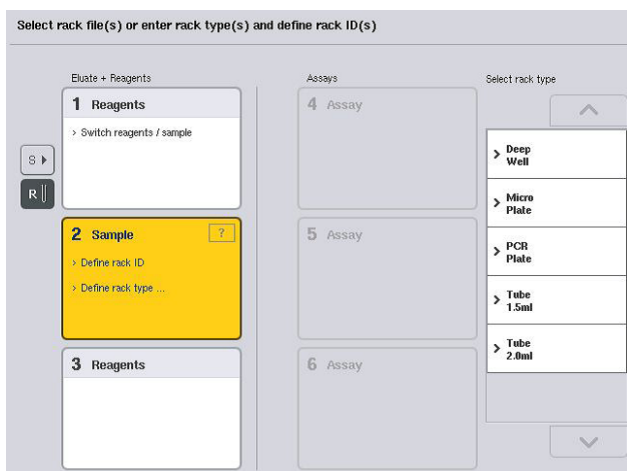

Defining an additional "Sample" slot

1. Press the **S** button to the left of slot 1 in the **Sample Rack(s)** screen.

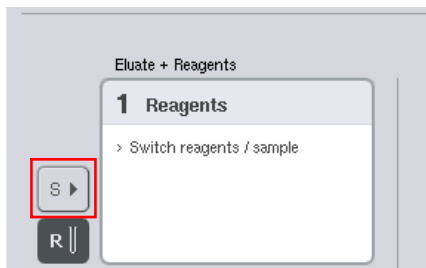

The "Reagents" slot will then switch to a "Sample" slot. This slot will be automatically selected and will be highlighted dark yellow.

2. To switch slot 1 from a "Sample" slot back to a "Reagents" slot, press the **R** button.

Assigning a rack type

If a rack file will not be used, each defined "Sample" slot must be assigned a rack type. To assign a rack type, follow the steps below.

1. Press a "Sample" slot to select it. A selected "Sample" slot is highlighted dark yellow.
2. Select a rack type from the **Select rack type** list.

The selected rack type will be assigned to the selected "Sample" slot(s).

Assigning sample rack ID(s)

If a rack file will not be used, each defined "Sample" slot must be assigned a rack ID.

A rack ID can be assigned manually or automatically. The assigned rack ID will be used to create a rack file. The name of the rack file has the format **RackFile_rack ID**.

Note: Be aware that some symbols may not be used in the rack file name and some symbols will be converted.

Note: If the rack type is changed after a rack ID has been entered the rack ID will remain the same.

Note: In cases where an eluate rack with 2D bar-coded tubes is used, the eluate tube bar code is appended to the ID of the sample ID with a blank in between within the result file. For more information on enabling eluate racks with 2D bar coded tubes, see Section 6.2.2 of the *QIAsymphony SP/AS User Manual – General Description*.

Manually assigning a sample rack ID

1. Select a "Sample" slot.

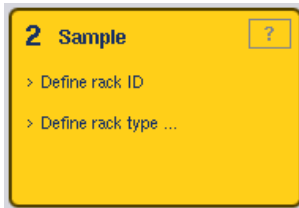

Rack ID

2. Press Rack ID. The Manual Input screen will appear.

3. Manually enter a rack ID using the **Keyboard**. Alternatively, use the bar code scanner to enter a rack ID.
4. Press **OK** to return to the **Sample Rack(s)** screen.

The entered rack ID will appear. If a rack type has already been assigned to the "Sample" slot, the slot will now appear blue.



Automatically assigning a sample rack ID

1. Select a "Sample" slot.

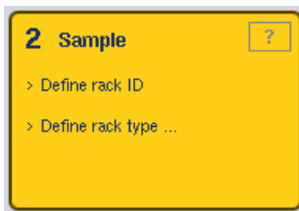

Automatic ID

2. Press **Automatic ID**.

The software automatically assigns an ID in the format **SlotNo._RunID_Suffix** (e.g., S2_1000002_000).

3. A rack ID is automatically assigned to the selected "Sample" slot(s). If a rack type has already been assigned to the "Sample" slot(s), the slot(s) will now appear blue.

Assigning a rack file

1. Press a "Sample" slot to select it. Ensure that only one "Sample" slot is selected. A selected "Sample" slot is highlighted dark yellow.

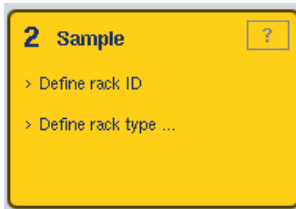

2. To deselect a "Sample" slot, press it. It will then appear pale yellow.



3. Press **Rack Files**.

The **Select rack file** list appears.

4. Press a rack file to select it from the list.

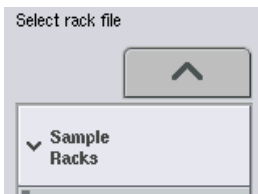

There are 3 types of rack files — **Sample Racks**, **Normalization Racks** and **Assay Racks**.

Sample Racks are standard sample rack files for defining an assay run. In some cases, the assay rack can be used as a sample rack (e.g., for setting up two-step RT-PCR assays). In this case, an **Assay Rack** can be selected.



5. When the assay rack file is selected, an information message appears.

Press **Yes** to continue.

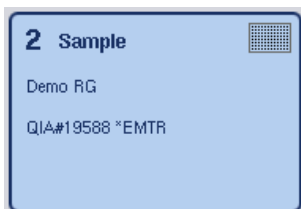

The selected rack file will be assigned to the selected "Sample" slot. The rack type and rack ID that are defined in the selected rack file will be assigned to the selected "Sample" slot. The "Sample" slot will now appear blue and the **Next** button becomes active.

Note: In cases where an eluate rack with 2D bar-coded tubes is used, the eluate tube bar code is appended to the ID of the sample ID with a blank in between within the result file. For more information on enabling eluate racks with 2D bar coded tubes, see Section 6.2.2 of the *QIAasympyony SP/AS User Manual — General Description*.

12.4.2 Defining/checking sample rack(s)

Once rack file(s) and rack type(s) have been assigned to “Sample” slot(s), the positions of samples and controls and the associated volumes must be defined.

1. Press **Next** in the **Sample Rack(s)** screen.
2. The **Sample Rack Layout** screen appears.

This screen displays a schematic of the sample rack in the selected “Sample” slot. If two “Sample” slots were defined, the **Slot 1** and **Slot 2** buttons can be used to switch between views of the two “Sample” slots.

If rack file(s) were assigned, sample positions, extraction controls, and volumes are already defined and are displayed in the sample rack layout. It is only possible to modify the sample volumes. This may be necessary if some eluate was manually removed from the rack before being placed on the QIAsymphony AS. It is not possible to define additional sample positions.

If rack file(s) were not assigned, sample positions, control positions, and volumes must be manually defined. When a rack file has not been assigned it is also possible to edit the sample IDs.

Note: Samples and/or extraction controls that have been processed on the QIAsymphony SP and marked as “invalid” are marked in red. These “invalid” sample and extraction controls cannot be processed by the QIAsymphony AS and cannot be selected by the user in the **Assay Assignment** screen. In the **Assay Assignment** screen, any “invalid” samples appear as an empty well.

Note: If an assay rack file is being used as a sample rack file the abbreviations used for assay standards (Std), no template controls (NTC, NTC+IC, NTC-IC; where IC is internal control), and assay controls (AC) are not displayed — only the volume is visible. Press the position (pale yellow) to select it, and then select **Sample**, **EC+** or **EC-** to define the sample type (where EC is extraction control).

The **Next** button becomes active after sample positions and volumes have been assigned to the sample rack.

3. Press **Zoom in** to view the name of sample IDs.

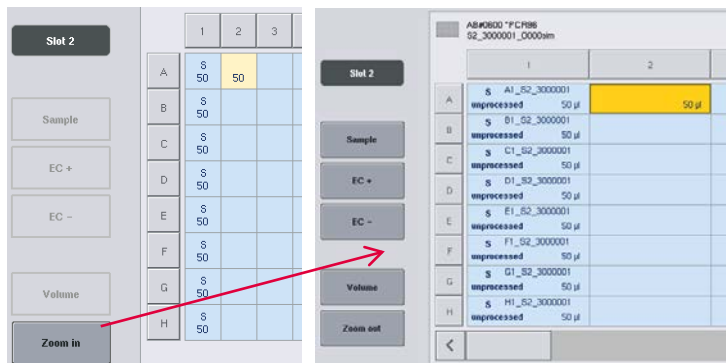

Note: Small fluctuations in the expected volume of eluate are dependent on the QIAAsymphony SP protocol. This means that the maximum number of reactions that can be set up per sample may no longer correspond to the available volume of eluate.

Selecting positions in the sample rack

Before samples, controls, and volumes can be defined, positions in the sample rack must be selected.

- To select individual position(s), press individual position(s) in the rack.
- To select a complete column or row, press the number or letter that is associated with that particular column or row.
- To select all positions, press **Select All**.
- To select a block of positions, press one position and drag your finger to select other adjacent positions.

Note: Selected positions appear dark blue.

Define sample positions and extraction controls

If a rack file has not been assigned, sample positions must be defined. To define sample positions, follow the steps below.

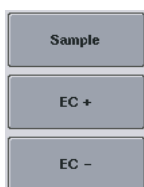

1. Select position(s) that contain samples.
2. Press **Sample**, **EC+**, or **EC-** to assign samples or extraction controls to the selected positions.
An **S**, **EC+**, or **EC-** will appear in each selected position. These positions will appear yellow and will be automatically deselected.

	1	2
A	S	S
B	EC-	EC+



- To delete position(s) that have been assigned, select the position(s) and press **Clear**.

Modifying/defining sample volumes

The volume in each position of a sample rack is not checked during the inventory scan; therefore it is important that manually defined volumes are accurate.

- Select the position(s) to be defined or modified in the displayed sample rack.

	1	2	3
A	S	S	S
B	S	S	S

- Press **Volume**.



The **Manual Input** screen appears.

- Enter a volume using the **Keyboard** screen.

200 µl		
7	8	9
4	5	6
1	2	3
0	.	

Note: 0 µl is not a valid volume. If a sample position contains no sample volume, clear the sample assignment from this position (see below).



4. Press **OK**. The **Sample Rack Layout** screen appears and the updated volume(s) will be displayed.



5. To delete entries for particular sample position(s), select the sample position(s) and press **Clear**.

Note: If a sample position contains no sample volume, clear the sample assignment from this position. To do this, select the sample position in the **Sample Rack Layout** screen, and press **Clear**. When a rack file is used, it is not possible to clear a sample assignment.

Viewing and editing sample IDs

Samples are automatically assigned default IDs based on their position, slot number, and run ID (e.g., **B1_S2_10000061**). Extraction controls are also marked as **EC+** or **EC-**. To view the sample IDs, press **Zoom In**. Use the arrow buttons to scroll through the sample rack.

If desired, the automatically assigned sample IDs can be edited.

Note: If a rack file was used, the sample IDs cannot be modified.

Modifying a sample ID

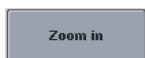

1. Press **Zoom In**. An enlarged view of the sample positions will appear.



2. Press the **Tools** tab.
The **Tools** menu will be displayed.



3. Use the arrows to scroll across the sample positions.

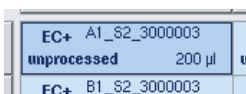

4. Select a sample position by pressing it. The selected position will appear dark blue.

5. Press **Sample ID**.
The **Manual Input** screen will appear.



6. Enter a sample ID using the keyboard, or enter a sample ID using the bar code scanner.



7. Press **OK**.

8. Repeat steps 1–6 for all sample IDs that need to be modified.

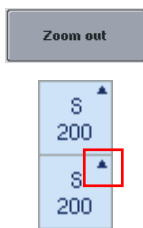

9. To return to the original view, press **Zoom Out**.

Sample positions with modified sample IDs will be marked with a small triangle in the top right corner.

12.4.3 Defining assay(s) to be processed in the run

To define which assay(s) will be processed in the run, press **Next** in the **Sample Rack Layout** screen.

The **Assay Selection** screen appears.

Assay panels and Assay Parameter Sets can be selected using this screen.

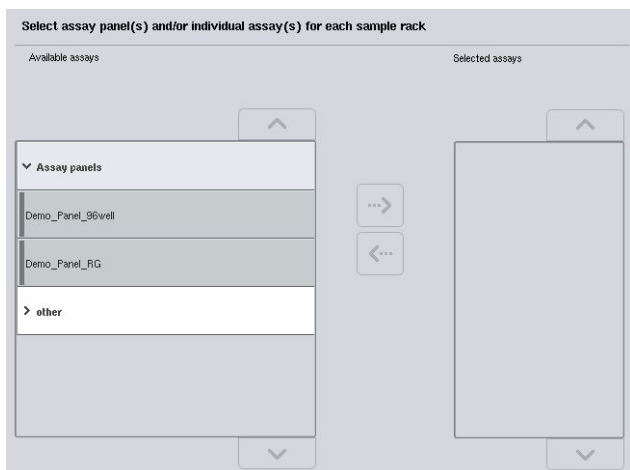

An Assay Parameter Set contains all information relating to an assay (e.g., number of replicates, assay controls, and assay standards). Each Assay Parameter Set references an Assay Definition file. The Assay Definition defines the assay workflow, reagents, and pipetting specifications. In addition, an Assay Parameter Set can reference a Normalization Definition file, if the assay uses normalization. The Normalization Definition defines the reagents and pipetting specifications for the normalization step.

It is possible to perform several different assays in the same run, but only if the Assay Parameter Sets use the same output format. The number of replicates in an Assay Parameter Set, including the number of assay standards and controls for specific assays, can be defined/modified using the touchscreen. The parameters can also be modified using the **Process Definition** editor tool of the QIASymphony Management Console.

For more information, refer to Section 14.7 of the *QIAsymphony Management Console User Manual*.

Assay Parameter Sets can be grouped into assay panels. A single Assay Parameter Set can be a member of more than one assay panel. When an assay panel is selected, all related Assay Parameter Sets are selected and displayed in the **Selected assays** list. If one of the related assays should not be processed it has to be deselected manually.

In addition, Assay Parameter Sets can be sorted into different categories. All available panel(s) and categories are listed in the **Available assays** list. All Assay Parameter Sets that are not part of a category are listed in **Other**.

Selecting Assay Parameter Sets

Assay Parameter Sets can be assigned manually or using work list(s).

A work list defines which samples should be processed by which Assay Parameter Sets. If at least one work list is available for the defined sample IDs, the **Work List** mode is used by default.



The **Work Lists** button is then active and appears dark blue.

Only Assay Parameter Sets that are defined by the work list are displayed in the **Available assays** list.

If a work list is not available, or if assays that are not specified in a work list need to be processed, assay panels and individual assays can be selected manually.

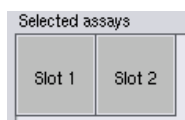

1. If more than one "Sample" slot is defined, select the slot that you want the assays to be assigned to using the tabs at the top of the **Selected assays** list. If you want the assays to be assigned to both slots, press the **Slots 1/2** tab.
2. Press assay panels or individual assays from the **Available assays** category to select them.

Assays can be divided into sections (e.g., **Assay panels** and **other**), but these can be modified using the **Process Definition** editor tool of the QIAsymphony Management Console.

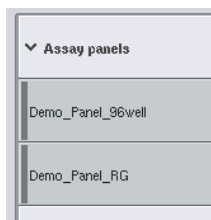

3. Press the desired assay panel.
All related assay parameter sets are displayed.



4. Press the right pointing arrow in the center of the screen to move the selected assay panel.
All Assay Parameter Sets related to the selected assay panel will automatically be displayed in the **Selected assays** list.

Note: If you do not want to process any of these listed assays, press the assay to select it, and then press the left pointing arrow. The assay will be deselected and will be removed from the **Selected assays** list.

12.4.4 Assigning selected assays to sample positions

If more than one Assay Parameter Set is selected in the **Assay Selection** screen, the **Assign each assay individually?** option appears.

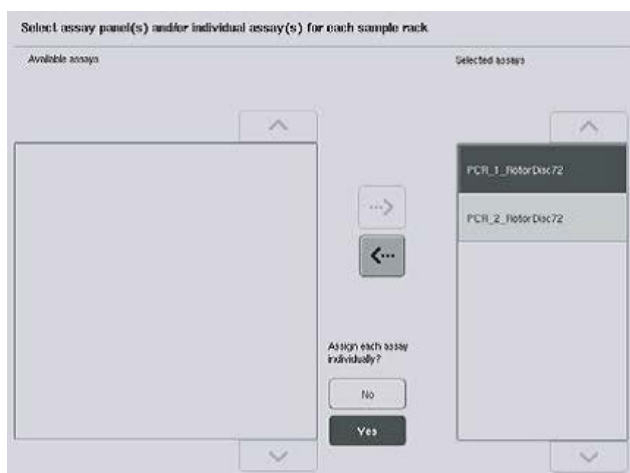

Yes is selected by default.

This means that the selected Assay Parameter Sets have to be individually assigned to sample positions in a sample rack (i.e., each Assay Parameter Set does not have to be assigned to every sample).

If samples are to be processed by all selected Assay Parameter Sets, select **No**.



1. Press **Next** to continue.

The **Assay Assignment** screen appears. This screen displays a schematic of the sample rack in the selected "Sample" slot.

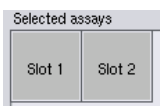

2. If more than one "Sample" slot is defined, use the **Slot 1** and **Slot 2** buttons to switch between views of the two slots.

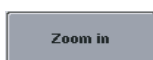

3. Press **Zoom in**.

Details for the assay positions are shown, including sample ID and, for an assay with normalization, concentration.



4. Press **Zoom out**.

Return to the previous view of the **Assay assignment** screen.



5. If a work list(s) is used, Assay Parameter Sets are automatically assigned to samples, as defined in the work list(s).

Those samples that have assays assigned to them appear green and are marked with a work list symbol.



6. To view a detailed overview of each sample position, press **List view**.

7. After assigning assays to sample positions, press Queue in the Assay Assignment screen to proceed with loading the QIASymphony AS.



The **Loading Information** screen appears. The **Queue** button is only active when each Assay Parameter Set has been assigned to at least one position in each "Sample" slot that has been defined.

If a work list is not available, Assay Parameter Sets must be manually assigned to samples.

Only samples that have assays assigned to them will be processed in the assay setup run.

Note: After pressing **Queue**, the assignment and modification of Assay Parameter Sets is saved and cannot be changed, and it is not possible to return to the **Assay Assignment** screen. If you press **Cancel**, all defined settings will be deleted. Press **Yes** to confirm.

Manually assigning Assay Parameter Sets

1. Select an Assay Parameter Set to be assigned from the tabs.

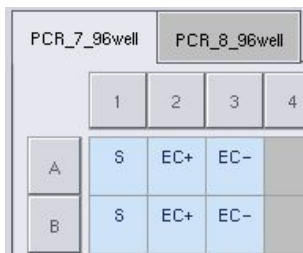

If **No** was selected for **Assign each assay individually?** in the **Assay Selection** screen, it is not possible to select individual assays. A single tab, **All Assays** is automatically selected



2. Select the sample positions to which the Assay Parameter Set(s) should be assigned, and press **Assign**.

The selected Assay Parameter Set(s) will be assigned to the selected positions. A number will appear in the bottom right corner of the assigned sample positions. This number indicates the number of Assay Parameter Sets that have been assigned to a particular sample.

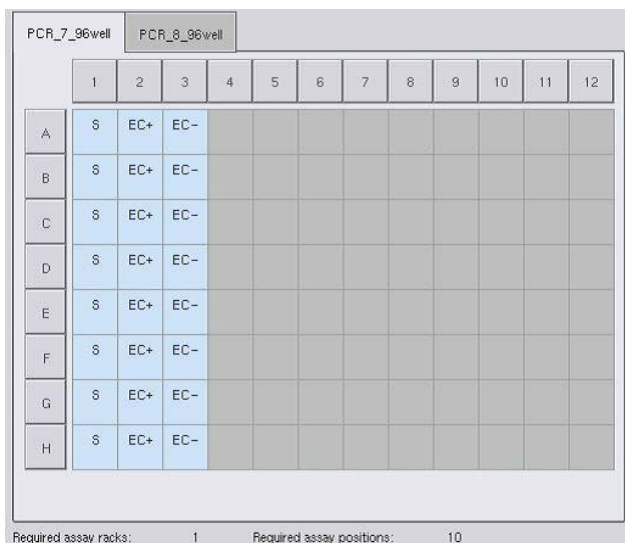

Note: The **Queue** button becomes active when at least one sample is assigned to every assay and when at least one sample is assigned to each slot.

12.4.5 Modifying assay parameters

The assigned Assay Parameter Set defines the default parameters for a run. To change the assay parameter(s), proceed as follows:



1. Press **Specifications**.

The **Assay Specifications** screen will appear.

2. Select the tab for the Assay Parameter Set. The **Assay Parameter Set** list will be displayed.



3. Select the Assay Parameter Set for which the parameter will be changed from the tab list.



4. Press **Yes** or **No** to define whether or not a ready-to-use master mix will be used.

> **Sample**

> **Assay controls**

> **Assay standards**

5. Select one of the three headings to view a list of parameters.

6. Modify the desired parameters.

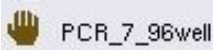

After modifying a parameter, the associated value appears green. A hand symbol is displayed in the active assay tab and next to the modified parameter.

7. Press **OK**.

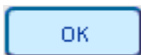

All changes will be saved and the system will return to the **Assay Assignment** screen.

Note: For "Read only" Assay Parameter Sets, only the number of replicates can be modified.

Note: For user-defined output patterns, the number of replicates for assay controls and for assay standards cannot be modified.

Note: Empty positions defined with the user-defined output pattern cannot be analyzed with Rotor-Gene AssayManager.

Note: It is not possible to modify assay parameters in work list mode.

Note: If the parameters are modified, the changes will not be saved in the Assay Parameter Set. They will be used for the current run only. To change parameters in an Assay Parameter Set for future runs, use the **Process Definition** editor tool of the QIASymphony Management Console. For further information, refer to the *QIASymphony Management Console User Manual*.

12.4.6 Queuing an independent assay run

When assay definition is completed the assay run can be queued. Proceed as follows:



1. Press **Queue** in the **Assay Assignment** screen.

The QIASymphony SP/AS instruments now validate the assay run and create a loading information file.

Once an assay run is queued it is not possible to return to the assay definition process

2. The **Loading Information** screen appears.

You can now load the instrument worktable. Refer to Section 12.4.1 for more information

12.4.7 Validating the assay run

QIAsymphony SP/AS instruments validate all defined values for the assay run and determine whether the assay run can be loaded. The validation process includes the following checks:

- Checks that the number of assay positions required does not exceed the number of positions available on the assay rack(s), according to the defined Assay Parameter Set(s) (internal software check)
- Checks that the total volume of master mix required does not exceed the available volume in the largest master mix bottle (internal software check)
- For sample positions that need normalization, checks that the dilution parameters are in specified range

If anything is incorrect, an error message will appear informing the user about exactly what is incorrect. The run cannot be loaded until the message is acknowledged and the problem is corrected.

Creating the loading information file

When **Queue** is pressed while **Auto Transfer** is active, the loading information file will be created and printed. The loading information file contains all information that the user requires for loading reagents, sample rack(s), assay rack(s), and disposable filter-tips into the QIAsymphony AS drawers.

For detailed information about the **Auto Transfer** tool, refer to Section 8 of the *QIAsymphony Management Console User Manual*.

12.4.8 Loading an independent run

For details about how to load the QIAsymphony AS, see Section 12.4.8.

If your independent run includes a normalization step, see the following sections.

Viewing loading information (only for assay run with normalization)

Press the **Normalization** slot in the **Loading information** screen to view detailed information about the required normalization rack.

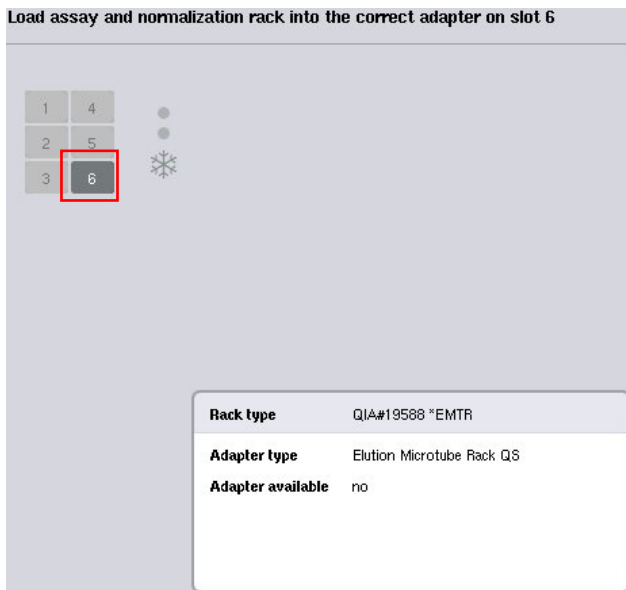

Assay Setup/Loading Information screen.

Loading a normalization rack (only for assay run with normalization)

To load a normalization rack, proceed as follows:

1. If not already open, open the "Assays" drawer. Temporary cooling for defined slots is started.
2. In the **Assay Setup/Loading information** screen press the **Normalization** slot (highlighted yellow).

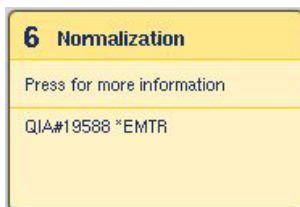

Detailed loading information for the slot is shown.



3. Place the empty normalization rack in the appropriate adapter on slot 6, or, if requested by the software, into slot 4 for a two-step normalization or when reaction positions for one normalization rack are exceeded.



4. Press **Load**. The **Assay Setup/Loading information** screen reappears.

The loaded slot is now highlighted blue.

5. Leave the "Assays" drawer open to load disposable filter-tips (see "Loading disposable filter-tips" on page 121).

Note: Ensure that the appropriate adapter is used with the normalization rack.

Note: Do not load partially filled normalization racks.

12.4.9 Checking cooling temperatures

For instructions about how to check cooling temperatures, see Section 12.3.3.

12.4.10 Starting an independent run

Wait until the cooling positions have reached their target temperatures (i.e., when they appear green in the assay setup **Overview** screen).

Press **Run** in the assay setup **Overview** screen.

The screenshot shows the 'Overview' screen with the following data:

Status	Run ID	Assay	Destination	Time
QUEUED	3000002	Multiple	Slot 5, Slot 6	

Reagent	Current Temperature	Target Temperature
Slot 1	--	--
Slot 2	5.4°C	6.0°C
Slot 3	5.9°C	6.0°C

Assays	Current Temperature	Target Temperature
Slot 4	--	--
Slot 5	5.4°C	6.0°C
Slot 6	5.2°C	6.0°C

If an inventory scan was performed after pressing the **Queue** button, provided that the validation showed no error and nothing was changed after that point, the inventory scan will be skipped and the assay run starts immediately.

If an inventory scan was not performed after pressing the **Queue** button, a message will appear asking whether an inventory scan should be performed for each drawer.

See Section 12.4.7 for detailed information about validating the assay run.

12.4.11 Removing assays after an independent run

When an assay run is completed or canceled, the assays must be removed from the “Assays” drawer. The assays will not be automatically removed from the QIAasymphony AS.

If the status of a run is shown as **QUEUED**, **STOPPED**, or **COMPLETED**, the assay rack(s) and adapter(s) can be removed.

It is possible to remove assays after an independent run in the same manner that they are removed after an AS run; see Section 12.3.5. Alternatively, follow the steps below.

1. Open the “Assays” drawer.

The **Assay Setup/Loading Information** screen appears.

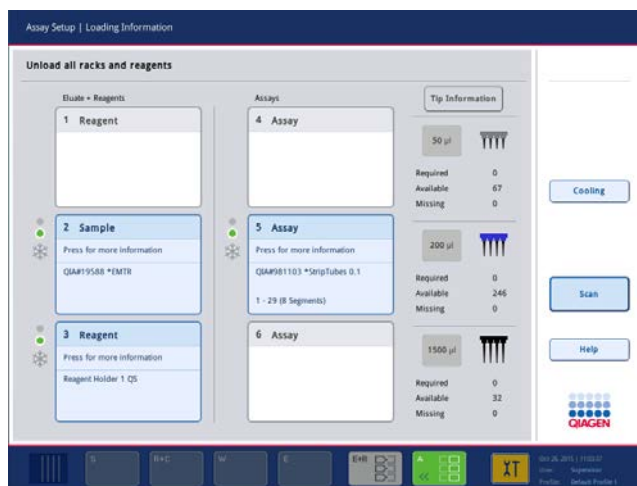

- Press the first assay rack to be removed.

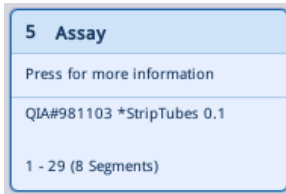

The detailed screen for the slot appears.

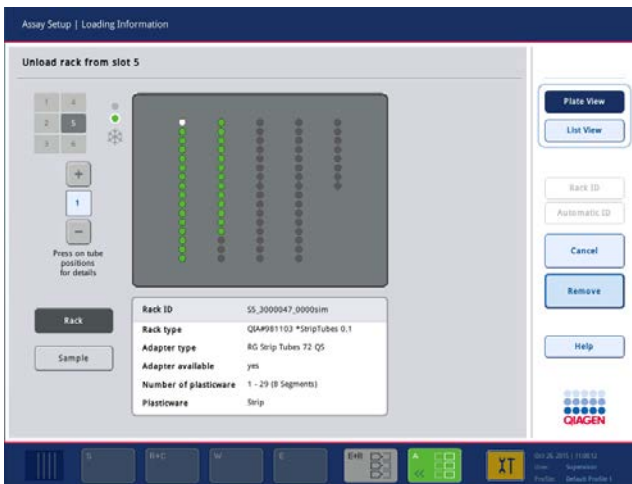

- Press **Remove** and unload the rack.



The **Assay Setup/Loading Information** screen appears again. The "Assay" slot now appears white and slot cooling is turned off.

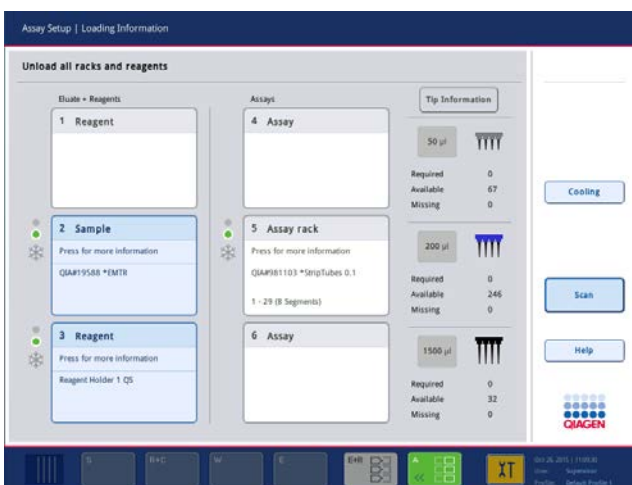

- Close the "Assays" drawer.



5. Press **Scan**.

A dialog box appears.

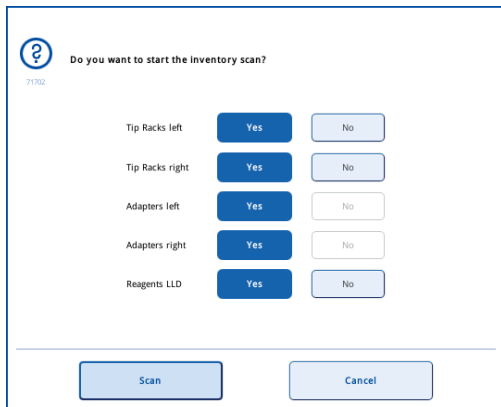

6. Select **Yes** for **Adapters right** only. Press **Scan**.

Unloading the worktable

After the inventory scan is performed the **Assay Setup/Loading Information** screen appears again. Proceed as follows:

1. Open the "Eluate and Reagents" and "Assays" drawers. The **Loading Information** screen appears.
2. Press a sample rack to be removed.



The detailed screen for that slot appears.

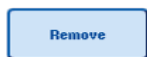

3. Unload the selected sample rack from the drawer and then press **Remove** in the touchscreen. If there is a second sample rack, repeat this process for the other rack.

4. Press a reagent rack to be removed.



The detailed screen for that slot appears.



5. Unload the reagent rack from the drawer and then press **Remove** in the touchscreen. If there is a second reagent rack, repeat this process for the other rack.

6. If there is a normalization rack, press this slot.



The detailed screen for that slot appears.

7. Unload the normalization rack from the drawer.

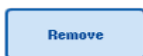

8. Press **Remove** in the touchscreen.

9. Remove empty tip racks.

10. Empty the tip disposal bag.



11. Close the drawers and press **Scan** to perform an inventory scan.

When the inventory scan is complete, the **Assay Setup Overview** screen appears.

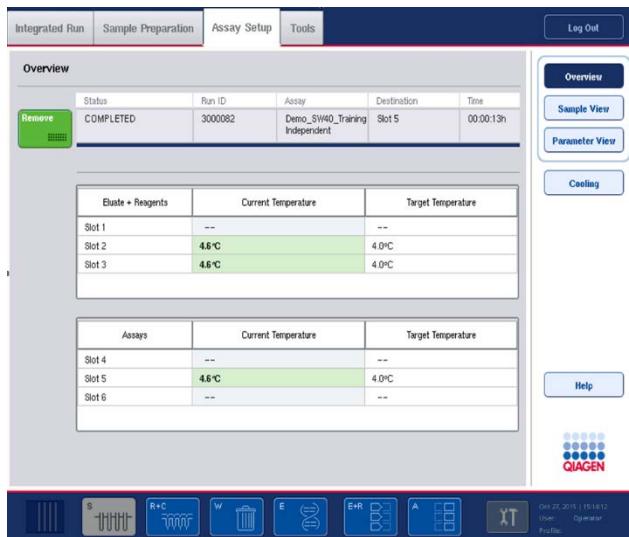

12. Press **Remove** in the assay setup **Overview** screen.

Note: A normalization rack containing unused positions cannot be used for subsequent runs as a normalization rack, but can be loaded as an eluate rack.

12.4.12 Pausing, resuming, and stopping an independent run



1. To pause or stop a run when a run is in progress, press **Pause AS** in the **Assay Setup Overview** screen



2. After pressing **Pause AS**, the **Continue AS** and **Stop AS** buttons appear. The run can now be resumed or stopped.



Samples will always be flagged as “unclear” if the run has been paused.

The QIAAsymphony AS will complete the current pipetting step before pausing.

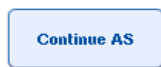

3. To resume a run, press **Continue AS**. To stop a run, press **Stop AS**.



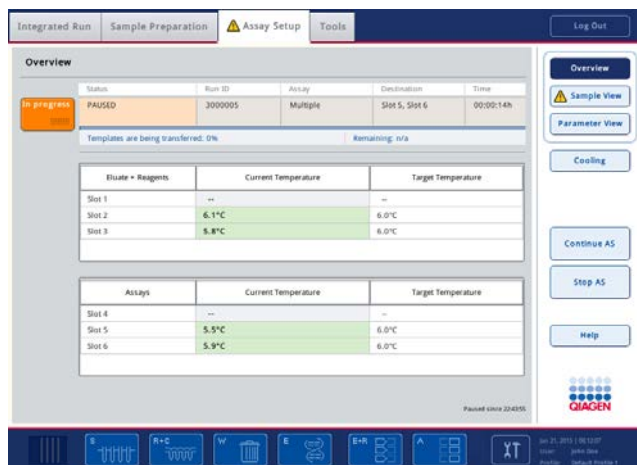

Note: Pausing a run interrupts the assay setup procedure and may affect assay performance. Only pause a run in an emergency.

If a run is canceled, all samples are flagged as “invalid” in the result file. It is not possible to process these samples further on the QIASymphony AS.

If a run is canceled, follow the procedure outlined in Section 12.3.5 to remove assays. It may be possible to continue manually processing the samples, for details refer to Section 2.19, “Protocol recovery”, of the *QIASymphony SP/AS User Manual – Operating the QIASymphony AS*.

12.5 Performing inventory scans (AS)

An inventory scan of each drawer of the QIASymphony AS must be performed before an assay run can be started. This is performed in the same way as for the QIASymphony SP drawers.

12.5.1 Inventory scan of “Eluate and Reagents” drawer

The inventory scan of the “Eluate and Reagents” drawer consists of the following steps in the following order:

1. Bar codes of slots 1–3 or bar codes of adapters on slots 1–3 are scanned.

Note: For a particular slot, either the bar code of the slot is scanned or, if an adapter is present on the slot, the bar code of the adapter is scanned.

- Bar codes of slots 1–3 are scanned to determine whether the slots are empty or occupied.
- Bar codes of adapters on slots 1–3 are scanned to determine whether a particular adapter type is present on a particular slot.

If the expected and current statuses of the slots/adapters do not match, a message will appear to prompt the user to correct the problem.

Note: The QIA Symphony AS is not able to identify the type of consumables on the adapter. It is therefore important that the correct plates/tubes are loaded on the adapters, as defined in the software.

2. Tip rack slots are scanned.

- The disposable filter-tips are scanned to ensure that the correct tip type has been loaded and that there are sufficient filter-tips available for the defined assay run.
- If a tip is detected in the first and last position of the tip rack, the tip rack will be categorized as full. If the first or last tip is missing, a full scan will be performed to determine the number of tips in the tip rack.
- If there are not enough filter-tips of the correct type available, a message will appear on the touchscreen prompting the user to load more tips.

Note: If there are insufficient tips available for the defined assay run and it is not possible to load more tips before starting the run, tips can be reloaded during the assay run. This will be documented in the loading information file, and in the result file if user interaction was required. Pausing the run to reload tips will result in the samples being flagged as “unclear”.

Partial inventory scan

If you need to repeat an inventory scan for the “Eluate and Reagents” drawer (e.g., if a change has been made on the worktable), you can perform a partial inventory scan. You can choose to scan the following worktable items separately:

- Tip Racks left
- Tip Racks right
- Adapters left
- Adapters right
- Reagents LLD

12.5.2 Inventory scan of the “Assays” drawer

The inventory scan of the “Assays” drawer is performed on slots 4–6 as for slots 1–3 of the “Eluate and Reagents” drawer.

If an inventory scan of the “Assays” drawer needs to be repeated, it is also possible to perform a partial inventory scan where tip racks and adapters can be scanned separately.

After the inventory scan has been performed, the inventory of the QIAAsymphony SP/AS instruments is updated. The system switches off temporary cooling for the slots and switches on cooling for loaded slots.

Note: The inventory scan must be performed before a run can be started.

12.5.3 Transfer to a PCR cycler

After assay setup, assays are removed from the QIAAsymphony AS and can be manually transferred to a PCR cycler for detection. A choice of output formats enables use of different PCR cyclers (e.g., Rotor-Gene Q, 96-well cyclers, 32-capillary cyclers) for detection. Cycler files can be exported from QIAAsymphony SP/AS instruments to selected PCR cyclers.

13 Troubleshooting

13.1 Error messages and warnings

If a problem occurs during operation of the QIASymphony SP and/or AS, an error message or warning will appear on the touchscreen.

See Section 3.2.3 of the *QIASymphony SP/AS User Manual – Operating the QIASymphony SP* for more information about the different symbols that may occur in error messages.

If the error has an error code it is displayed on the left side of the message, below the error symbol (see below). The error message is displayed in the middle of the dialog box

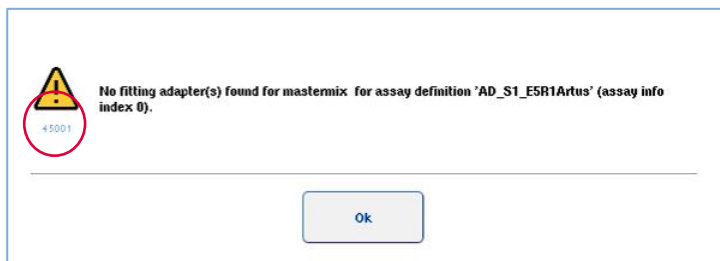

13.1.1 Errors indicated in the status bar

In some cases, errors are indicated by the drawer buttons flashing yellow in the status bar. Press the flashing button to view the error message and follow instructions.



13.1.2 Errors indicated in the tab headers

The different tab headers support an error indicator within the tab. Thus, in some cases, errors are indicated by a warning sign icon next to the tab header name.

13.1.3 Errors indicated in the command bar

In case of an error, a warning sign icon will be displayed within the menu button affected, next to the name.

Switch to the affected tab or press the command bar button concerned for an overview of the error situation within the dialog.

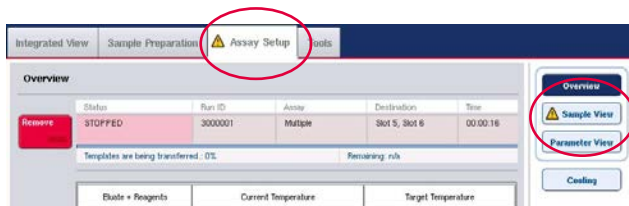

Error indication in tab headers and command bar buttons.

13.1.4 Messages with **Help** button

If a message appears with a **Help** button, the user has access to instructions about how to solve the problem.

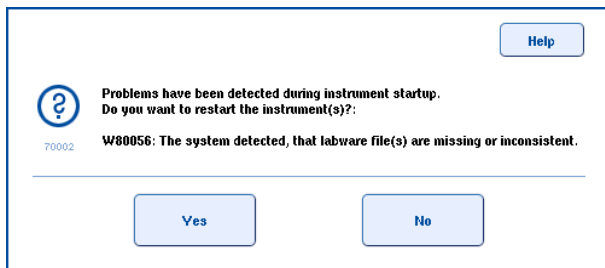

Proceed as follows:

1. Press the **Help** button. A new message will appear.

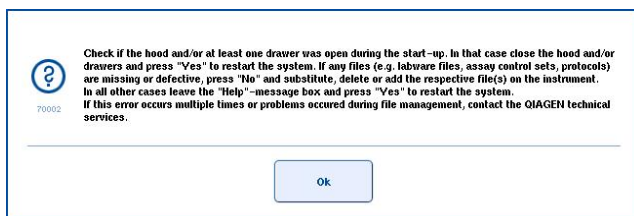

2. Carefully read the instructions and then press **OK**.
3. Close the message and follow the instructions.

Note: To read the message again, select **Instrument Report** in the **Tools** screen. Then select the **Errors** tab. Recent error messages will be listed there.

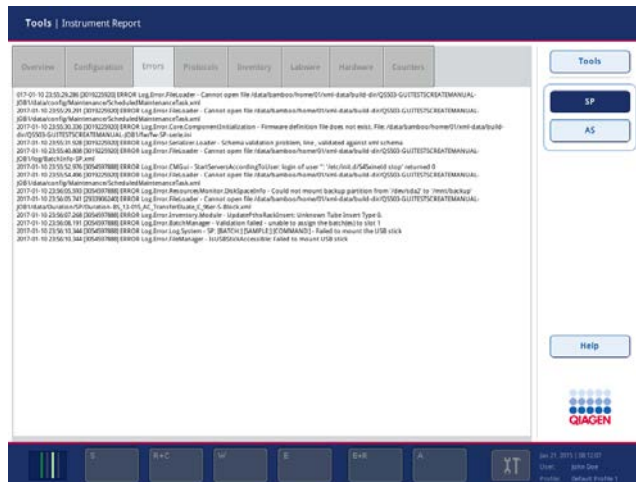

13.1.5 Messages without **Help** button

If a message appears that does not have a **Help** button, perform one of the following:

- Confirm the message and then follow the instructions that were outlined in the message.
- If the message does not have an error code, follow the instructions for context-specific errors listed in Section 13.4, Section 13.5, Section 13.6 and Section 13.7.
- Call QIAGEN Technical Services if recommended or required.

13.2 Software help boxes

In order to assist and guide the user, the QIAsymphony SP/AS provides a software help for all screens.

To access the software help texts, press the **Help** button in the command bar, which appears in all screens.

Pressing this **Help** button will open a dialog in front of the actual screen. The displayed text within the help message gives advice on how to handle the current screen.

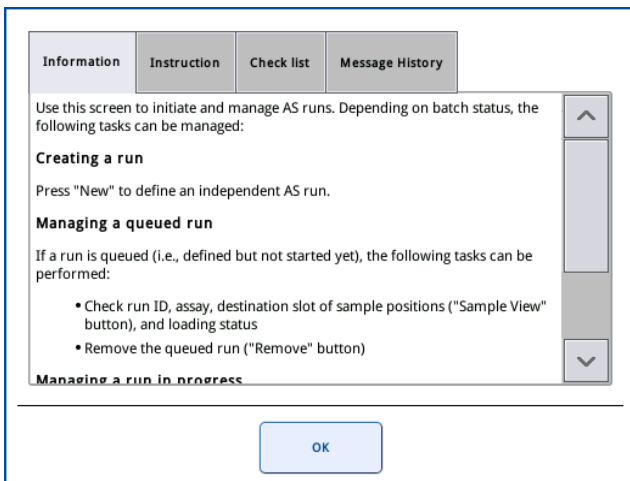
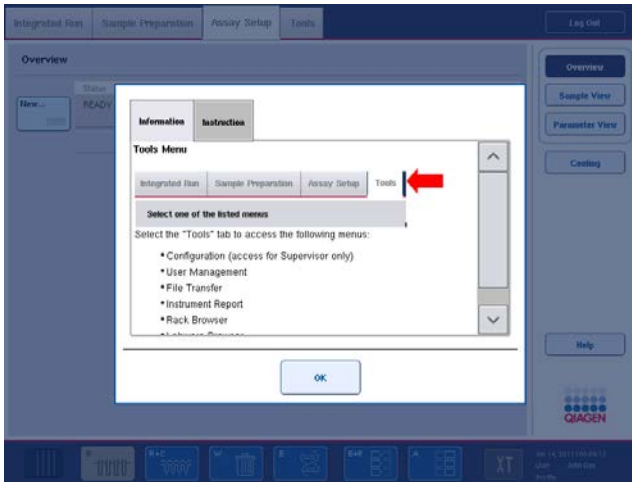

To return to the original screen, press **OK** inside the help dialog.

13.2.1 Structure of software help boxes

A help box consists of a maximum of 5 different tabs (in the following sequence): **Errors**, **Information**, **Instruction**, **Check list** and **Message History**.

Errors	The Errors tab displays additional information on dialog content that is marked as erroneous. The tab filters the information for selected positions, if they exist.
Information	The Information tab displays notes about the screen's behavior and/or information about the screen's view. The help text describes options for the user in context.
Instructions	The Instructions tab shows a detailed description of the steps the user will need to execute.
Check list	The Check list tab includes a selection of different topics the user may check for the actual context. The particular checks described within the checklist do not need to be rigorously executed.
Message History	By clicking the relevant row in Message History , the corresponding message will be shown together with the corresponding help text, if it is available.

Note: A software **Help** dialog may consist of fewer than these types of text.

13.3 Contacting QIAGEN Technical Services

If an error persists and you need to contact QIAGEN Technical Services, make a record of the incident and create an instrument report file.

13.3.1 Make a record of the incident

1. Note down all steps that were performed before and after the error occurred.
2. Document any messages that appeared on the touchscreen.

Note: It is important that you can tell us the error code and the associated text. This information will help the QIAGEN Field Service Specialist and Technical Services to resolve the error.

Note: In some cases the software does not list the error message on the touchscreen. The error is documented in the system log file either for the QIAsymphony AS or QIAsymphony SP.

3. Note the date and time at which the error occurred.
4. Provide a detailed description of the incident. For example, provide a photograph of the worktable and record the following information:
 - Where on the QIAsymphony SP/AS instruments did the error occur?
 - In which step of the protocol did the error occur?
 - What was observed (e.g., has something broken, are tips or sample prep cartridges in unusual places on the worktable?) and what was expected?
 - Was there any unexpected noise?

In addition, if relevant, provide the following information.

- If tips were lost during pipetting, provide the lot number and tip type.
- Were tip racks manually refilled?
- Which reagent adapter, including manufacturer and ordering number, was used?
- Which sample and eluate racks, including manufacturer and ordering number, were used?
- Which assay rack, including manufacturer and ordering number, was used?

13.3.2 Creating an instrument report file

If you are requested by QIAGEN Technical Services to create an instrument report file, proceed as follows:

1. Log in to the instrument(s).
2. Select **Instrument Report** in the **Tools** menu. The **Overview** tab of the **Instrument Report** menu appears and instrument data will be retrieved.

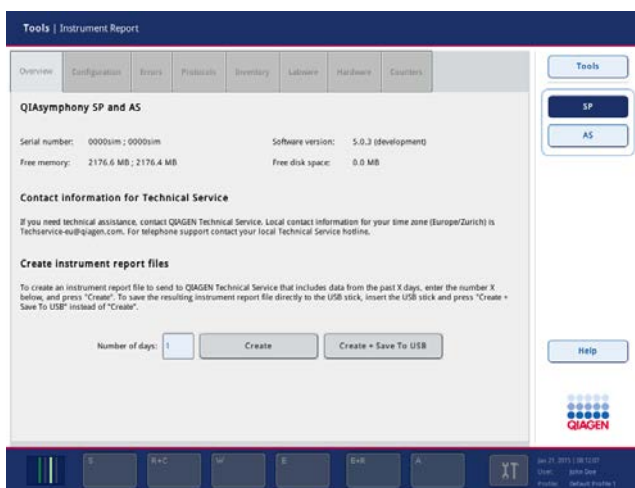

3. To create an instrument report for the QIASymphony SP, select **SP**. To create an instrument report for the QIASymphony AS, select **AS**.
4. Enter the number of days for which you want the instrument report file to cover.
5. Press **Create**, or to save the file directly to the USB stick, insert the USB stick and then press **Create + Save to USB**.

To download all instrument report files to the USB stick, see Section 8.3.2 of the *QIASymphony SP/AS User Manual – General Description*. Instrument report files can also be downloaded using

the QIASymphony Management Console. See Section 4 of the *QIASymphony Management Console User Manual* for more information.

Note: If an instrument incident occurs (i.e., problem, crash, etc.), generate an instrument report file and ensure that all files and information are available for QIAGEN Technical Services.

13.4 General errors that do not have error codes

Error	Comments and suggestions
The startup screen does not appear and the status LEDs are not illuminated.	Contact QIAGEN Technical Services.
Error occurs during an assay run.	An assay run was in progress on the QIASymphony AS and an error occurred. The QIASymphony SP/AS instruments must be switched off. Upon restarting the instruments, it is not possible to continue with the assay run or a protocol that was in progress at the same time on the QIASymphony SP.
Error occurs during a protocol.	If a protocol was in progress on the QIASymphony SP and an error occurs, the QIASymphony SP/AS instrument must be switched off. Upon restarting the instruments, it is not possible to continue with the protocol or an assay run that was in progress on the QIASymphony AS. For information on how to continue with manual assay setup, see Section 2.13 of the <i>QIASymphony SP/AS User Manual – Operating the QIASymphony AS</i> .

13.4.1 File handling errors

Error	Comments and suggestions
USB stick or other USB device was not recognized.	Only use the USB stick provided with the QIASymphony SP. Try connecting the USB stick to the other USB port. Restart the QIASymphony SP/AS instruments. Note: For file transfer, use the QIASymphony Management Console.
Signature invalid/Invalid checksum.	During file transfer via a USB stick, the new files are loaded again. If a file (e.g., Assay Control Set, Assay Parameter Set) is unsigned, an error message will be displayed (“signature invalid” or “invalid checksum”). However, the name of the invalid file is not given. The newly transferred file could be invalid, but this is not necessarily the case. Check the validity in the QIASymphony Management Console. Delete any unsigned files. Do not delete other file types.

13.4.2 File errors

General file errors

Error	Comments and suggestions
File not transferred.	Check that the file is in the correct folder on the USB stick.
Invalid checksum.	Ensure that the file was created by the QIASymphony SP/AS instruments or using the QIASymphony Management Console.

Rack file errors

Error	Comments and suggestions
Rack file could not be loaded.	<p>Ensure that the rack file has been uploaded to the QIASymphony SP/AS instruments.</p> <p>Check the parameter Ready for AS. This parameter should be set to Yes. If it is not set to Yes, the rack file must be modified. To do this, convert the *.xml file to *.csv format using the CSV Conversion tool of the QIASymphony Management Console. Then, correct the parameter using Microsoft® Excel® or Notepad. See Section 8.12 of the <i>QIASymphony SP/AS User Manual – General Description</i> for more information.</p>
Rack file contains wrong labware.	<p>Ensure that the racks/tubes and adapters that are written in the rack file are compatible with the QIASymphony SP/AS instruments. For a full list of compatible racks and adapters, visit www.qiagen.com/goto/QIASymphony.</p> <p>Ensure that the names of the racks and adapters are correctly spelled and that there are no incorrect blanks at the beginning or the end of the names.</p>
Sample positions are incorrect.	<p>For a user-generated rack file convert the *.xml file back to *.csv format using the CSV Conversion tool of the QIASymphony Management Console. Correct the positions of the samples using Microsoft Excel or Notepad.</p> <p>Ensure that the correct rack file is selected.</p>
Rack file could not be found.	<p>Ensure that the correct rack file has been transferred to the QIASymphony SP/AS instruments.</p> <p>Ensure that the correct rack file has been transferred to the QIASymphony SP/AS instruments before starting assay definition.</p> <p>The rack file must be in a format that can be recognized by the QIASymphony SP/AS instruments (i.e., *.xml). Ensure that the rack file has been converted from *.csv format to *.xml format using the CSV Conversion tool of the QIASymphony Management Console.</p>
Content of system generated file is wrong.	<p>Check whether actualization is correct.</p> <p>Ensure that no errors occur during the process.</p>

Work list errors

Error	Comments and suggestions
Work list could not be found.	<p>Ensure that the correct work list has been transferred to the QIA Symphony SP/AS instruments before starting assay definition.</p> <p>Ensure that the work list has been converted to *.xml format using the CSV Conversion tool of the QIA Symphony Management Console.</p> <p>If using the QIA Symphony AS, ensure that the work list has not expired. Press Assay Lists and check if the required Assay Parameter Set(s) are listed. If the required Assay Parameter Set(s) are listed, the work list has probably expired.</p>
Assay list does not display expected Assay Parameter Set.	<p>Ensure that the work list has not expired. Press Assay Lists and check if the required Assay Parameter Set(s) are listed. If the required Assay Parameter Set(s) are listed, the work list has probably expired.</p> <p>Ensure that the Assay Parameter Set(s) and Assay Definition files that are defined in the work list have been transferred to the QIA Symphony SP/AS instruments before starting assay definition.</p> <p>Ensure that the name and unique ID of the Assay Parameter Set that is defined in the work list is identical to the name and unique ID that is defined in the Assay Parameter Set.</p>

Labware errors

Error	Comments and suggestions
The labware is not visible in the Assay Setup Sample Rack(s) and Assay Setup Assay Rack(s) screen.	<p>Check the Labware Browser menu (see Section 3.16 of the <i>QIA Symphony SP/AS User Manual – Operating the QIA Symphony SP</i> and Section 3.8 of the <i>QIA Symphony SP/AS User Manual – Operating the QIA Symphony AS</i>).</p> <p>Ensure that the labware file has been transferred to the Labware AS folder.</p> <p>Ensure that the labware file was saved in the correct folder on the USB stick (data/Labware/AS/).</p> <p>Ensure that the labware file has been transferred to the QIA Symphony SP/AS instruments before starting assay definition.</p> <p>Check all categories of listed labware.</p>

Cycler file errors

Error	Comments and suggestions
Cycler file is not created or is not correct for the cycler.	<p>The QIASymphony SP/AS instruments automatically create a cycler file when an assay run is finished. The format of the cycler file depends on the assay rack type. Ensure that the correct cycler file format for the assay rack(s) is defined in the Assay Parameter Set. If necessary, modify the cycler file format in the Assay Parameter Set using the Process Definition editor tool of the QIASymphony Management Console.</p> <p>If the required assay rack format for a particular cycler file format is not available to be selected in the QIASymphony Management Console, ensure that the available assay racks are updated in the QIASymphony Management Console. See the <i>QIASymphony Management Console User Manual</i> for more details about how to do this.</p>

Result file AS errors

Error	Comments and suggestions
The final result file is not created./Only a preliminary result file is visible.	<p>The QIASymphony SP/AS instruments create a preliminary result file when an assay run is started. The final result file is created when Remove is pressed at the end of an assay run.</p> <p>If using automatic transfer, check in the related folder to see if the correct printer is listed.</p> <p>Ensure that you are looking in the correct folder for the QIASymphony SP result files or the QIASymphony AS result files. The correct folder is log/Results/SP or log/Results/AS.</p>
Result file AS is not accessible because QIASymphony is started up without AS	<p>An AS run stops due to technical error and the system creates an AS result file. Afterwards, if QIASymphony is started up without the AS module connected it is not possible to access the AS result file using QMC or USB stick.</p> <p>Restart the system with AS module connected to download the AS files. If this is not possible, contact QIAGEN Technical Services.</p>
Sample status.	<p>If errors/problems occur during an assay run, sample status can be affected.</p> <p>If samples were successfully processed, the sample status is "valid". If the batch was paused, the samples will be "unclear" and if, for example, cooling problems occur during a run, the sample status may be "unclear". If problems occur during master mix or sample transfer, the sample status is "invalid".</p> <p>If a QIASymphony SP rack file is used on the QIASymphony AS, the sample status will only be changed if errors/problems occur during the assay run. If sample status is changed, the reason for this change will be recorded in the QIASymphony AS result file. The message, the message ID, and the sample status is listed in the Detailed Run Information section of the QIASymphony AS result file.</p>

Loading information file errors

Error	Comments and suggestions
The loading information file is not created or printed.	<p>A loading information file should be generated after pressing Queue.</p> <p>Ensure that you are looking for the loading information file in the correct folder. The correct folder is \log>LoadingInformation.</p> <p>If using the automatic file transfer tool of the QIASymphony Management Console, check in the related configuration to see if the correct printer is listed.</p>

Log file errors

Error	Comments and suggestions
General transfer problems.	<p>Ensure that the QIASymphony SP/AS instruments are connected to the network when using the QIASymphony Management Console for file transfer.</p> <p>Ensure that the USB stick is correctly plugged in.</p>

13.4.3 Tip waste errors

Error	Comments and suggestions
Tips are stacking in the tip chute.	Ensure that the tip disposal bag is empty and that it is not jammed between the drawer and the workbench.
Tips are spilled in the lab.	Ensure that the tip disposal bag is correctly attached to the waste bag holder.

13.4.4 Configuration menu errors

Error	Comments and suggestions
The adapter for AS is not displayed in the configuration dialog.	Ensure that you have transferred the adapter file(s) to the Labware AS folder.

13.4.5 Inventory scan errors

Error	Comments and suggestions
Run cannot be started because an inventory scan has to be performed.	<p>Before the user can start a run, an inventory scan of each drawer except the "Sample" drawer must be performed. Open and close the drawers to start the inventory scan.</p> <p>If an inventory scan has already been performed, do not open the hood before starting the run. If the hood was opened after performing an inventory scan the scan has to be carried out again.</p>
Inventory scan does not start.	Ensure that the hood and all drawers are properly closed.
The inventory scan of the drawers detects an adapter on "slot X" although no adapter has been placed there./Adapter bar code not readable.	<p>Ensure that the bar codes on the drawer are clean and can be easily read.</p> <p>Do not expose the QIA Symphony SP/AS instruments to direct sunlight (see Section 3.1).</p> <p>If there is an unneeded adapter on the elution slot, be sure to remove it.</p>
Consumables are not recognized correctly by inventory scan.	<p>Check that consumables (unit boxes, buffer bottle, tip racks, Accessory Trough, tip chute, etc.) are placed correctly on the corresponding drawer.</p> <p>Check that lids of unit boxes and buffer bottle have been removed.</p> <p>Only place Accessory Troughs into tip rack slots 5 and 12 (SP).</p> <p>Open and close the drawer and start the inventory scan again.</p> <p>Ensure that the tip chute is correctly installed on the QIA Symphony (SP and AS).</p> <p>Note: It is recommended to load only full tip racks.</p> <p>Note: Do not refill partially used unit boxes.</p>
Volume check of buffer bottle failed.	Make sure that the bottle contains sufficient volume of buffer.
Volume check of the Accessory Trough failed.	<p>Make sure that the Accessory Trough contains sufficient volume of ethanol. For more information, refer to the handbook of the QIA Symphony Kit you are using.</p> <p>Perform another inventory scan of the "Reagents and Consumables" drawer.</p>
Reagent cartridge was not opened automatically by the system.	<p>Make sure that a piercing lid was attached to the reagent cartridge.</p> <p>Note: If the inventory scan detects an unopened reagent cartridge, the reagent cartridge will be opened automatically before the first use in a protocol.</p>

Error	Comments and suggestions
One or more buffers were not recognized.	Make sure that the Reuse Seal Strips have been removed from the troughs of the reagent cartridge.
The elution drawer was opened while an inventory scan was running and the "Elution Rack" screen cannot be exited.	The scan of the "Elution" drawer is queued and will be performed as soon as the current inventory scan has finished.
After starting and closing the "Eluate Drawer" dialog without changes, the inventory scan of the "Eluate" drawer starts.	This is the correct behavior if you open and close the hood and press No, nothing changed on the displayed message box. After this, a full scan will be performed on leaving the "Eluate Drawer" dialog without changes.
The bar code of an elution or assay rack cannot be read using the handheld bar code scanner.	<p>Make sure that the handheld bar code scanner is correctly connected to the QIASymphony SP/AS instruments. Try to read other bar codes with the scanner. Ensure that all bar codes can be easily read.</p> <p>Check that the bar code format can be read by the handheld bar code scanner. See Appendix A of the <i>QIASymphony SP/AS User Manual — General Description</i> for a list of compatible bar code types.</p> <p>Define the elution slot/elution rack using the touchscreen.</p>
Sample bar codes are not read properly/not detected.	<p>Only use compatible bar codes. Refer to Appendix A of the <i>QIASymphony SP/AS User Manual — General Description</i> for detailed information about compatible bar codes.</p> <p>Be sure that bar codes can be easily read and are oriented to the left.</p>
Tube/plate carrier was not recognized during loading.	<p>Be sure to position the bar code at an appropriate height in the rack. Make sure that the bar code fits into the cut-out of the tube carrier and position the bar code at the height of the plate carrier's bar codes.</p> <p>If you are using duplicate sample bar codes do not place them next to each other in the sample carrier. In this case, place different sample bar codes between the identical ones.</p> <p>Remove the carrier and insert again more slowly. Remember to pause at the stop line.</p>

13.5 QIASymphony SP errors that do not have error codes

13.5.1 "Eluate" drawer

Error	Comments and suggestions
Filter-tips are bent or deformed after eluate transfer.	Be sure to define the correct type of eluate rack on the corresponding elution slot. Make sure that the elution rack is correctly positioned on the elution slot. Only use elution racks that are compatible with the specified adapter.
Tips/channels are incorrectly positioned on the elution slot during the elution step.	Make sure to place the elution rack onto the elution slot in the correct orientation. Be sure to insert and to define the same sample tube. Only use compatible sample tubes/ racks. For more information about tubes and racks, visit www.qiagen.com/goto/QIASymphony .
The "Eluate" drawer cannot be opened.	The "Eluate" drawer is locked during eluate transfer. After transfer of eluates to the elution rack, the system unlocks the "Eluate" drawer If the "Eluate" drawer cannot be opened after eluate transfer, open the Maintenance menu and press the Drawers button under Unlock .
It is not possible to define an elution rack.	Open the "Eluate" drawer and leave the drawer open while defining an elution rack.
Eluates are not in the corresponding elution rack as described in the result file.	Be sure to set up the elution rack with well A1 at the upper left corner.
After closing the "Eluate" drawer, the information about the elution rack entered by the user was not stored by the system and an error message is displayed after performing the inventory scan.	After you have entered information about the elution rack, press the Add button before you close the drawer so that the changes to the information are saved.

13.5.2 "Sample" drawer

Error	Comments and suggestions
Sample carrier locks do not release and/or bar code reader does not move forward.	<p>Make sure that the QIA Symphony SP is switched on and the LEDs in the "Sample" drawer are illuminated green. Be sure to insert all tube/plate carriers with the bar codes oriented to the left. Move the carrier up to the stop line and wait. Make sure that all bar codes can be read. If this does not resolve the problem, restart the QIA Symphony SP/AS instruments.</p> <p>Open the Maintenance SP menu and press the Sample carrier button under Unlock.</p>
Samples have been physically removed from the system but a result file cannot be downloaded.	<p>In order to download a result file containing detailed information about the samples, remove the corresponding elution rack from the inventory.</p>

13.5.3 "Waste" drawer

Error	Comments and suggestions
Liquid in the "Waste" drawer.	<p>Check that the lid of the liquid waste container has been removed. Make sure to insert the liquid waste container in the correct orientation. If the liquid waste container overflowed, contact QIAGEN Technical Services to ensure that the liquid did not cause malfunctions.</p>
"Waste" drawer cannot be opened.	<p>The "Waste" drawer is locked during a run and during the inventory scan. If the drawer cannot be opened after the protocol has finished, open the Maintenance SP menu and select Drawers under Unlock.</p>
"Waste" drawer cannot be closed.	<p>Make sure to place the liquid waste container in the "Waste" drawer at the right-hand side of the drawer. Remove the lid of the liquid waste container before you place it in the "Waste" drawer.</p>

13.5.4 "Reagents and Consumables" drawer

Error	Comments and suggestions
The "Reagents and Consumables" drawer cannot be opened.	<p>The "Reagents and Consumables" drawer is locked during a run and during the inventory scan.</p> <p>If the drawer still cannot be opened after the protocol has finished, open the Maintenance SP menu and select Drawers under Unlock.</p> <p>Be sure that both piercing devices/reagent cartridges have been moved to the lower position. If not, open the Maintenance SP menu and select Piercing Device 1/2 down under Move.</p> <p>Note: Do not use force to open the drawer.</p>

13.5.5 Errors that may occur when starting a batch/run

Error	Comments and suggestions
Run button is inactive.	Make sure that the tube/plate carrier has been loaded and that the batch status is QUEUED .
One or more batches cannot be queued.	The system detected 2 or more samples with the same sample ID. Make sure the sample ID is unique. Sample ID could not be read during loading of the tube/plate carrier. Remove the tube/plate carrier and reload it more slowly. Make sure that all bar codes are oriented to the left and are readable.
Wrong sample IDs are shown in sample view.	If two or more tube carriers are inserted: <ul style="list-style-type: none">● Remove all carriers.● Insert a carrier and wait until the bar code camera has returned to its home position and the corresponding batch has changed state.● Insert remaining carriers in the same way.● Before inserting a new carrier, wait until the corresponding batch has changed state.

13.5.6 Protocol errors

Error	Comments and suggestions
Assay Control Set is not displayed.	Make sure that the Assay Control Set was transferred to the QIA Symphony SP. Check all categories in the Assay Control Set list.

13.5.7 Errors that may occur while operating the QIA Symphony SP

Error	Comments and suggestions
One or more channels had a Z-drive movement error.	Be sure to insert and to define the same tube/plate. Only use compatible tubes/racks. For more information, visit www.qiagen.com/goto/QIASymphony . Make sure that the tubes/plates are properly inserted in the tube carrier/adaptor. Use an appropriately sized tube or rack for the volume. If filter-tips are still attached to the tip adapters, open the Maintenance SP menu and select Cleanup under Cleanup . Select the Crash occurred branch of the cleanup procedure. Important: After successful cleanup it is necessary to empty all slot positions in the "Sample" and "Eluate" drawers and restart the machine. New runs can then be started.

Error	Comments and suggestions
Sample is not detected by the system and is flagged as "invalid".	Make sure the samples do not contain foam. Be sure to use at least the minimum volume of sample required for the protocol. For more information, refer to the handbook of the QIA Symphony Kit you are using.
Nothing happens when the Cleanup button in the Maintenance SP menu is pressed.	Check that the hood and all drawers are closed.
Lysis timer exceeded the time limit.	The lysis time of the sample batch was exceeded. Do not pause the run during the lysis step. Note: If another inventory scan of the "Eluate" drawer is performed after the run has started, this may result in the samples being flagged as "unclear".

13.5.8 Protocol run interruption

Error	Comments and suggestions
System paused due to too few consumables in the "Reagents and Consumables" drawer.	Open the "Reagents and Consumables" drawer and add missing items. Close the drawer and perform an inventory scan. Note: Samples will be flagged as "unclear". Note: If one or more tip adapters cannot pick up filter-tips, contact QIAGEN Technical Services.
Inventory scan of the "Eluate" drawer starts even though a batch is running.	Each time the "Eluate" drawer is opened and closed an inventory scan must be performed. During the scan the batch/run is paused, which leads to samples being flagged as "unclear". The batch continues when the inventory scan has finished. After a successful scan of the "Eluate" drawer, the user must press Close to continue. Note: All drawers except the "Eluate" drawer are unlocked during an inventory scan of the "Eluate" drawer.
The protocol was interrupted or stopped by the system due an error.	The worktable must be cleaned up. Open the Maintenance SP menu and select Cleanup under Cleanup . Select the Crash occurred branch of the cleanup procedure. See Section 2.23.1 of the <i>QIA Symphony SP/AS User Manual – Operating the QIA Symphony SP</i> . Important: After successful cleanup it is necessary to empty all slot positions in the "Sample" and "Eluate" drawers and restart the machine. New runs can then be started.

Error	Comments and suggestions
The system stopped because an 8-Rod Cover or sample prep cartridge could not be released from the robotic gripper.	<p>Switch off the QIASymphony SP/AS instruments and try to remove the 8-Rod Cover or sample prep cartridge from the QIASymphony SP manually. If it cannot be removed manually, contact QIAGEN Technical Services.</p> <p>Note: Do not initialize the QIASymphony SP/AS instruments.</p>

13.6 QIASymphony AS errors that do not have error codes

13.6.1 Assay definition errors

Error	Comments and suggestions
Wrong rack file content.	<p>Ensure that the content of the selected rack file is correct.</p> <p>If the content is not correct, it can be modified using the touchscreen or the QIASymphony Management Console.</p>
Wrong rack type.	<p>If possible, return to the Sample Rack(s) screen and change the rack type. If this is not possible, press Cancel and restart the assay definition process.</p> <p>If you are using a rack file, ensure that the correct rack file is selected.</p>
Wrong volume information for the eluate rack.	<p>If the actual sample volume available is greater than the volume that was defined in the Sample Rack Layout screen, overflow may occur during aspiration.</p> <p>If the actual sample volume available is lower than the volume that was defined in the Sample Rack Layout screen, signals may be missing.</p>
Sample cannot be assigned to an APS.	<p>Samples with the status "invalid" cannot be processed on the QIASymphony AS and therefore cannot be selected during assay definition.</p> <p>Ensure that the sample you want to select is not "invalid".</p>
Assay list does not display expected Assay Parameter Set.	<p>Ensure that the required Assay Parameter Set(s) and Assay Definition files have been transferred to the QIASymphony SP/AS instruments before starting assay definition.</p> <p>Check all categories in the Available assays list for the expected Assay Parameter Sets.</p> <p>Check whether the expected Assay Parameter Set was configured for usage in Independent or Integrated mode.</p> <p>In Assay Setup/Assay Selection screen, if using a work list, switch between the Assay list and the Work list mode and check all categories in the Available assays list for the expected Assay Parameter Sets.</p> <p>Note: This only applies in Independent mode.</p>

13.6.2 Errors occurring during an assay run

Problems with labware or with liquid spills

Error	Comments and suggestions
Liquids in adapter.	Ensure that all consumables are placed in the correct positions on the worktable. The inventory scan does not check whether the correct tubes/plates are placed in the corresponding adapters.
Condensation on the worktable.	Depending on the environment in the laboratory, it is possible that condensation forms on the worktable. Wipe away condensation according to the daily maintenance procedures, see Section 9.2 of the <i>QIASymphony SP/AS User Manual – General Description</i> .
Filter-tips are bent or deformed after liquid transfer.	Ensure that the correct rack type is defined on the correct slot. Ensure that the rack is correctly positioned on the adapter. Only use rack types that are compatible with the defined adapter.

Assay run interruption

Error	Comments and suggestions
The protocol was interrupted or stopped by the system due to an error.	Remove consumables from the worktable. If necessary, see Section 2.13 of the <i>QIASymphony SP/AS User Manual – Operating the QIASymphony AS</i> for details about protocol recovery and manually completing assay setup. Any stop, pause, or interruption of a protocol will lead to samples being flagged as “unclear”.
Not enough liquid found.	Ensure that the correct volume is provided and that the plates/tubes and adapters as defined in the assay definition are provided. Ensure that there are no air bubbles on the surface of the liquid. Add more liquid.

13.6.3 Data analysis errors

Error	Comments and suggestions
Missing sample signal.	<p>Possible evaporation: If eluates/assays are left to stand on the QIAAsymphony SP/AS instruments for a long time after a run is complete, evaporation will occur. Ensure that eluate racks and assay racks are removed immediately when a run is completed.</p> <p>Check if the eluate volume as defined in the rack file or on the touchscreen is higher than the actual eluate volume. The QIAAsymphony SP/AS instruments may not be able to transfer the correct sample volumes. This may result in reduced performance.</p> <p>Fluctuations in eluate volumes: It is recommended to check the assay rack visually for differences in sample volumes. Large differences in volume indicate that the actual eluate volume differs from the expected volume and that insufficient eluate was transferred to the assay rack. If problems persist, reduce the eluate volume.</p> <p>Ensure the correct adapters and consumables, as defined for the current run, are loaded on to the worktable. Use of different consumables may result in damage to the QIAAsymphony SP/AS instruments and may cause pipetting problems.</p> <p>Ensure that the assay rack and the elution rack are set up in the correct orientation, with well A1 in the upper left corner. If two elution racks are in use, ensure that the elution racks on slot 1 and slot 2 are correctly placed.</p> <p>Ensure that the correct sample tubes are loaded, as defined in the run. Only use sample tubes/racks that are compatible with the QIAAsymphony SP/AS instruments. For a full list of compatible sample tubes/racks, visit www.qiagen.com/goto/QIAAsymphony.</p>

13.7 Integrated run errors

13.7.1 "Eluate" drawer

Error	Comments and suggestions
The "Eluate" drawer cannot be opened.	<p>The "Eluate" drawer is locked as soon as Define Run button in the Integrated Run/Overview is selected (see Section 2.4, "Defining an integrated run", of the <i>QIAAsymphony SP/AS User Manual – Operating the QIAAsymphony AS</i>).</p> <p>It is only possible to open the "Eluate" drawer if no integrated batch is loaded or queued in the Integrated Run/Overview screen. To open the "Eluate" drawer, remove Integrated Batch(es) in the Integrated Run/Overview (see Section 2.16.1, "Unloading the worktable", of the <i>QIAAsymphony SP/AS User Manual – Operating the QIAAsymphony AS</i>).</p>

13.7.2 Removal of an integrated run

Error	Comments and suggestions
Integrated batch cannot be removed in the Integrated Run /Overview .	<p>To remove an Integrated run which cannot be removed in the Integrated run/Overview, the Assay Setup has to be manually booked out from the system (e.g., if sample preparation has finished and the AS batch cannot be started due to a previously stopped AS batch).</p> <p>To manually book out the AS batch from the integrated run, remove the AS batch by selecting the Assay Setup tab and press Remove in the Overview screen (see Section 2.9, "Removing assays after an AS run", of the <i>QIASymphony SP/AS User Manual – Operating the QIASymphony AS</i>). After removing the AS batch, return to the Integrated Run/Overview and remove the Integrated run by pressing the Integrated Batch X button (see Section 2.16.1, "Unloading the worktable", of the <i>QIASymphony SP/AS User Manual – Operating the QIASymphony AS</i>).</p>

13.7.3 Maintenance, service, and configuration

Error	Comments and suggestions
Maintenance is not accessible.	Remove loaded Integrated batches to access the Maintenance menu.
Service is not accessible.	Remove loaded Integrated batches to access the service menu.
Configuration is not accessible.	Remove eluate plate and scan the empty eluate drawer.

14 Maintenance

The table below describes the personnel required to carry out the maintenance to ensure optimal performance of your QIASymphony SP/AS instruments.

Type of task)	Frequency	Personnel
Regular maintenance	At the end of each run	Laboratory technicians or equivalent
Daily maintenance	At the end of each day, after the regular maintenance	Laboratory technicians or equivalent
Weekly maintenance	Once per week, after the regular and daily maintenance	Laboratory technicians or equivalent
Annual maintenance and servicing	Once per year	QIAGEN Field Service Specialists only

14.1 Maintenance scheduler

The maintenance scheduler assists the user with managing all maintenance tasks. It reminds the user of tasks that are due, provides an overview of the maintenance schedule and keeps record of the maintenance data.

Maintenance tasks can be divided into two categories:

- Regular maintenance
- Time-based maintenance

Regular maintenance procedures are event-driven tasks that must be performed after the respective event has finished. (e.g., regular maintenance SP and/or AS, regular maintenance integrated run).

Time-based maintenance procedures are time-dependent tasks that have a fixed time schedule (e.g., daily, weekly and monthly QIASymphony SP/AS tasks, as well as annual maintenance). Annual maintenance can only be confirmed by QIAGEN Technical Service. All maintenance tasks from QIAGEN are classified as mandatory.

Note: It is not possible to postpone or modify a mandatory maintenance task. When a mandatory task is due, the task must be performed. Depending on the Application Process files, it is either

possible to use the QIASymphony without flagging, with flagging, or the QIASymphony denies to start a run.

The maintenance scheduler is accessed using the **Tools** icon in the status bar (see image below). The **Tools** icon color indicates the status:



Blue: No pending maintenance tasks are due.



Yellow: One or more maintenance tasks are due.

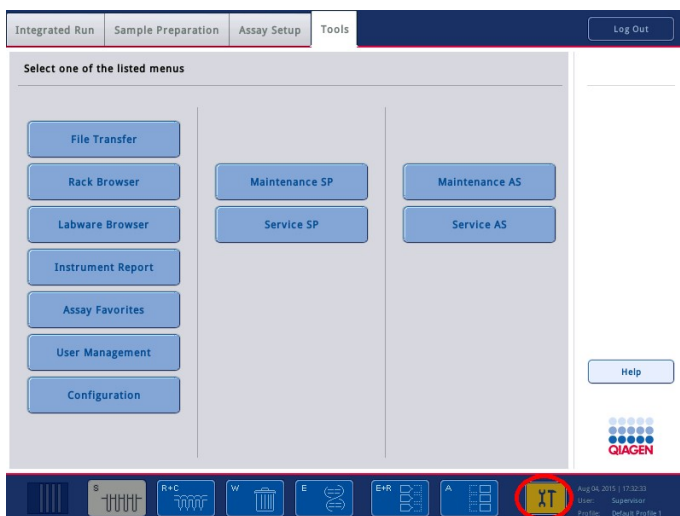

All maintenance tasks are listed in the **Confirm Maintenance Task** screen with their title, classification, due date/time and their recurrence pattern. Scheduled maintenance must be confirmed upon task completion by pressing the **Done** button.

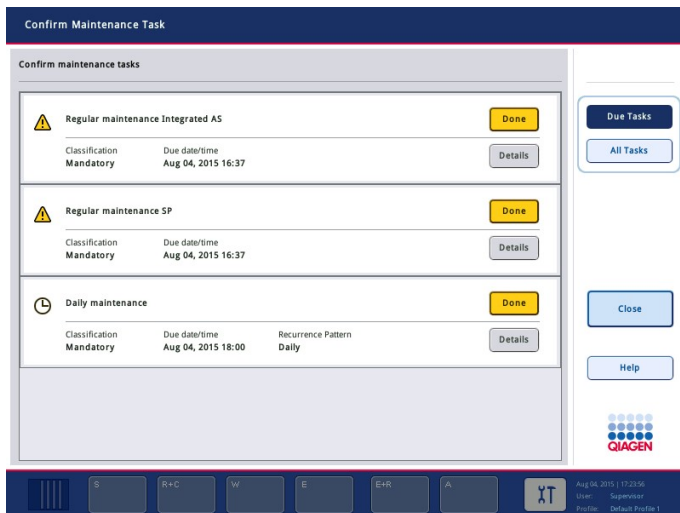

A confirmation can be canceled by pressing the **Undo** button. The **Details** button opens a message box listing all maintenance steps belonging to a maintenance task. The maintenance tasks are ordered with event-driven tasks listed first at the top, followed by date-driven tasks that are sorted according to their due date.

14.1.1 Confirming a maintenance task

To confirm a maintenance task:

1. Press the yellow flashing **Tools** icon in the status bar.
2. After performing the respective maintenance press **Done**. The selected task is confirmed, the background color changes to grey, the icon changes to an **OK** symbol and the confirmation date is displayed.

If the task is time-based, the next due date is scheduled.

Note: If you unintentionally confirm a maintenance task, press **Undo** to revert the task state to unconfirmed.

Displaying detailed steps for a maintenance task

To display all the required steps for a specific maintenance task, press the **Tools** icon and then press **Details** for a specific task. A message box is shown with a description of all necessary maintenance steps.

14.1.2 Postponing a maintenance task

Time-based maintenance tasks can be postponed once if (for example) you are working on a time-consuming batch and cannot start the maintenance immediately. For a postponed task, the due time

is set to 23:59 of the current day. The user must confirm the task the next day but cannot postpone the task a second time. To postpone a task, press **Postpone**.

14.1.3 Configuring the maintenance settings

The “Supervisor” can configure the maintenance settings in the **Tools/Configuration** menu. Only the due time and warning time can be modified.

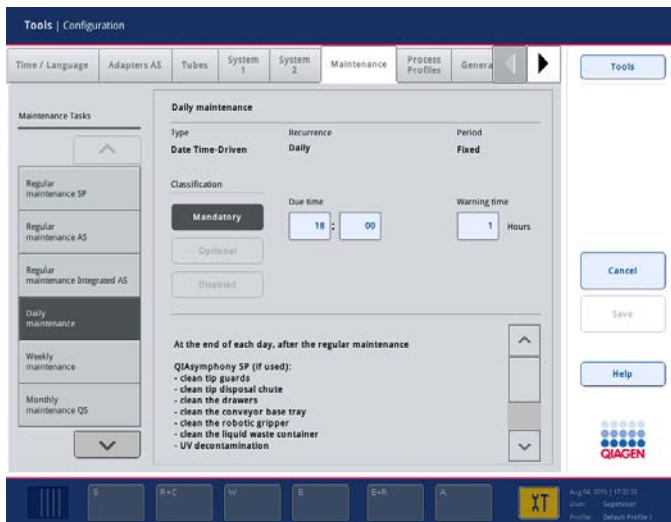

Different maintenance tasks can be selected in the **Maintenance Tasks** list:

- For **Daily maintenance**, it is possible to select the **Due time** and **Warning time**.
- For **Weekly maintenance**, in addition to the **Due time** and **Warning time**, the weekday when the maintenance should occur can be selected.
- For **Monthly maintenance QS**, the **Due time**, **Warning time** and **Day of month** can be selected.
- The **Annual maintenance and servicing** can only be initially set after the software update performed by the “Supervisor”. The **Due time**, **Warning time** and **Day, Month** and **Year** of the last **Annual service visit** must be set. All following **Annual maintenance and servicing** tasks can only be confirmed by QIAGEN Technical Services.

Note: It is only possible for QIAGEN Field Service to confirm the **Annual service visit** task.

Note: The safety information must be read thoroughly and understood before starting maintenance and servicing work. Pay special attention to Section 2.9.

14.2 Cleaning

Note: If liquid is spilled on the QIASymphony SP/AS worktables, wipe it away as soon as the run has finished in accordance with the required safety regulations. Do not allow the liquid to dry.

Cleaning agents

Disinfectants and detergents for cleaning

- Mikrozyd® Liquid (Schülke & Mayr GmbH; www.schuelke-mayr.com) — ethanol-based disinfectant for spraying onto items that have been removed from the QIASymphony SP/AS worktables
- Mikrozyd Wipes (Schülke & Mayr GmbH; www.schuelke-mayr.com) — moistened with ethanol-based disinfectant for wiping surfaces of the QIASymphony SP/AS
- Mikrozyd Sensitive Liquid (Schülke & Mayr GmbH; www.schuelke-mayr.com) — quaternary ammonium salt based disinfectant. Consists of 0.26 g quaternary ammonium compounds, benzyl-C12-C16-alkyldimethyl, chlorides; 0.26 g Didecyldimethylammonium chloride and 0.26 g quaternary ammonium compounds, benzyl-C12-C14-alkyl[(ethylphenyl)methyl]dimethyl, chlorides per 100 g Mikrozyd Sensitive Liquid). For alcohol-sensitive surfaces.

Removal of RNase contamination

- 5 PRIME RNaseKiller (5 PRIME, cat. no. 2500080) — for cleaning surfaces and submerging worktable items
- 0.1 M NaOH — as an alternative to 5 PRIME RNaseKiller for cleaning surfaces and submerging worktable items.

Removal of nucleic acid contamination (DNA and RNA)

DNA-ExitusPlus™ IF (AppliChem, cat. no. A7409,0100; indicator-free variant of DNA-ExitusPlus) — for cleaning surfaces and submerging worktable items.

Note: Do not use alcohol or alcohol-based disinfectants to clean the QIASymphony SP/AS hoods or side panels. Exposure of the QIASymphony SP/AS hoods and side panels to alcohol or alcohol-based disinfectants will cause surface cracking. Clean the QIASymphony SP/AS hoods and side panels with distilled water or Mikrozyd Sensitive Liquid only.

Europe

Gigasept® Instru AF (Schülke & Mayr GmbH; www.schuelke-mayr.com) — Consists of 14 g cocosporylene-diamine-guanidine diacetate, 35 g phenoxypropanols, and 2.5 g benzalkonium chloride per 100 g Gigasept Instru AF, with anticorrosion components, fragrance, and 15–30% nonionic surfactants. Disinfectant for submerging worktable items.

USA

DECON-QUAT® 100 (Veltek Associates, Inc.; www.sterile.com) — quaternary ammonium salt based disinfectant concentrate. Contains 5% alkyldimethylbenzylammonium chloride and 5% alkyldimethylethylbenzylammonium chloride). For submerging worktable items.

Note: If you want to use disinfectants different from those recommended, ensure that their compositions are similar to those described above. A suitable alternative to Mikrozyd Liquid is Incidin® Liquid (Ecolab; www.ecolab.com).

Note: If solvents or saline, acidic, or alkaline solutions are spilled on QIASymphony SP/AS instruments, wipe them away immediately.

Note: Do not use alcohol or alcohol-based reagents to clean the QIASymphony hood(s) or side-panels.

Important: Contact the instrument supplier if there are questions regarding the use of cleaning agents.

CAUTION Damage to the instrument(s)



After wiping the drawers, the perforated metal plate and lysis station with paper towels, make sure that no bits of paper towel remain. Pieces of paper towel remaining on the worktable could lead to a worktable collision.

14.3 Servicing

Contact your QIAGEN Field Service representative or your local distributor for more information about flexible Service Support Agreements from QIAGEN.

Note: Disconnect the line power cord from the power outlet before servicing.

14.4 Regular maintenance

Regular maintenance is required after each run on the QIASymphony SP/AS. A separate maintenance routine should be performed for the QIASymphony SP and QIASymphony AS.

Note: Before running a service protocol from the **Maintenance SP** or **Maintenance AS** menu, ensure that the QIASymphony SP/AS hoods are closed.

14.4.1 Regular disposal of tips

Note: To avoid contamination, the tip disposal bag must be emptied before starting the next run.

Note: Residual liquid from the tip disposal chute may drip.

Note: Pay attention to the safety information.

Note: When using the QIASymphony Cabinet SP/AS, the waste bin should be emptied to avoid contamination inside the cabinet.

Note: Check the waste bin regularly.

Note: Residual liquid from the tip disposal chute may drip inside the cabinet.

For detailed information, refer to the *QIASymphony Cabinet SP/AS User Guide*.

14.4.2 Regular maintenance procedure for the QIASymphony SP

The underlined words are the keywords the user sees on the touchscreen within the maintenance scheduler (see “Displaying detailed steps for a maintenance task”, page 176).

1. Remove eluates: Remove eluates from the “Eluate” drawer.
2. Download the result file(s)(optional): As an optional step, download the result file(s) and ensure that the files have been backed up.
3. Remove used sample tubes/plates: Remove used sample tubes/plates from the “Sample” drawer and discard according to your local safety regulations.
4. Remove reagent cartridges: Remove reagent cartridges from the “Reagents and Consumables” drawer.

Seal partially used reagent cartridges and store according to the instructions in the handbook of the QIASymphony kit you are using. Discard used reagent cartridges according to your local safety and environmental regulations.

5. Replace the tip disposal bag: Replace the tip disposal bag before starting the next run.
6. Discard unit boxes: Close unit boxes filled with waste plasticware and discard according to your local safety regulations.
7. Check the magnetic-head guards: Check the magnetic-head guards and clean if required.
8. UV decontamination (optional): Perform UV decontamination of the worktable (optional).

Note: When using the QIASymphony Cabinet SP/AS, the waste bin should be emptied to avoid contamination inside the cabinet.

For detailed information, refer to the *QIASymphony Cabinet SP/AS User Manual*.

If required, clean the magnetic-head guards before starting the next protocol run. Proceed as follows:

9. Open the **Maintenance SP** menu and run the service protocol **Magnetic head guards**. Gently raise the catches to release the magnetic-head guards.
10. Wipe the magnetic-head guards with ethanol-based disinfectant (e.g., Mikrozyd), and incubate as appropriate.
11. Wipe with a lint-free cloth moistened with water and wipe dry with paper towels. Replace the magnetic-head guards.
12. Open the **Maintenance SP** menu and run the service protocol **Open magnetic head guards**.

CAUTION **Damage to the instrument(s)**



Make sure to install the magnetic-head guards before operating the QIASymphony SP.

14.4.3 Regular maintenance procedure for the QIASymphony AS (integrated and independent)

The underlined words are the keywords the user sees on the touchscreen within the maintenance scheduler (see “Displaying detailed steps for a maintenance task”, page 176).

1. Remove assay run: Remove the assay run by pressing the **Remove** button.
2. Remove assays: Remove assays from the “Assays” drawer.
If desired, transfer assays directly to the PCR cycler.
3. Download the result file(s) (optional): Download the result file and, if available, the cycler file.
Ensure that these files have been backed up.
4. Remove used sample tubes/plates: Remove used sample tubes/plates from the “Eluate and Reagents” drawer. Either store safely or discard according to your local safety regulations.
5. Remove reagent tubes and bottles: Remove reagent tubes and bottles from the “Eluate and Reagents” drawer. Discard according to your local safety regulations.
6. Discard empty tip racks.
7. Replace the tip disposal bag: Replace the tip disposal bag before starting the next assay run.
8. UV decontamination (optional): Perform UV decontamination of the worktable.

Note: Do not refill used tip racks.

Note: When using the QIASymphony Cabinet AS, check if the tip disposal bag is full. The waste bin should be emptied to avoid contamination inside the cabinet.

For detailed information, refer to the *QIASymphony Cabinet SP/AS User Guide*.

14.5 Daily maintenance (SP/AS)

After performing the last run of the day, perform the regular maintenance procedure and, in addition, the daily maintenance procedure.

Note: Before running a service protocol from the **Maintenance** menu, ensure that the QIASymphony SP/AS hoods are closed.

Note: Pay attention to the safety information.

The underlined words are the keywords the user sees on the touchscreen within the maintenance scheduler (see “Displaying detailed steps for a maintenance task”, page 176).

14.5.1 Pipetting system tip guards (SP/AS)

Clean pipetting system tip guards

1. Open the **Tools** screen and press **Maintenance SP** or **Maintenance AS**.
2. Move the robotic arm to the cleaning position by pressing **Tip guards**.
3. Remove all 4 tip guards by pushing each tip guard upward until it clicks out of place and can be removed.
4. Soak in a glyoxal and quaternary ammonium salt based disinfectant (e.g., Gigasept Instru AF) for at least 15 min.
5. Rinse with water and wipe dry with paper towels.

CAUTION **Damage to the instrument(s)**



Make sure to install the tip guards correctly before operating QIASymphony SP/AS instruments.

14.5.2 Tip disposal chute

Note: If using the QIASymphony Cabinet SP/AS, refer to the instructions provided in the “Maintenance” section of the *QIASymphony Cabinet SP/AS User Guide*.

QIAsymphony SP

Clean tip disposal chute

1. Remove the tip disposal chute from the “Waste” drawer.
2. Soak in a glyoxal and quaternary ammonium salt based disinfectant (e.g., Gigasept Instru AF) for at least 15 minutes.
3. Rinse with water and wipe dry with paper towels.

QIAsymphony AS

Clean tip disposal chute

1. Open the **Tools** screen and press **Maintenance AS**.
2. Press **Robotic arm left** to move the robotic arm to the left.
3. Open the QIAsymphony AS hood.
4. Remove the tip disposal chute from the worktable.
5. Soak in a glyoxal and quaternary ammonium salt based disinfectant (e.g., Gigasept Instru AF) for at least 15 minutes.
6. Rinse with water and wipe dry with paper towels.

Note: Residual liquid from the tip disposal chute may drip.

14.5.3 Drawers and lysis station (SP)

Clean drawer and lysis station

1. Remove all removable objects (tube carriers, adapters, inserts, liquid waste station/tip park station, tip disposal chute, liquid waste bottle, waste bag holder, reagent box holder) from the drawers.
2. Wipe the drawers, the removed objects, and the lysis station with ethanol-based disinfectant (e.g., Mikrozyd) and incubate as appropriate. Then wipe with a cloth moistened with water and dry with paper towels. Return the objects to the drawers.
3. Clean the top plate of the piercing device.
4. Optional: Clean the removed objects by soaking them in a glyoxal and quaternary ammonium salt-based disinfectant (e.g., Gigasept Instru AF) according to the manufacturer’s instructions. After incubation according to manufacturer’s instructions, rinse the removed objects thoroughly with water.

Note: There are spikes below the piercing device in the “Reagents and Consumables” drawer that ensure that the reagent cartridge is correctly positioned. Take care when cleaning the “Reagents and Consumables” drawer.

14.5.4 Drawers (AS)

Clean the drawers

1. Remove all removable objects (tubes/plates, adapters) from the drawers.
2. Wipe the drawers and the removed adapters with quaternary ammonium salt based disinfectant (e.g., Gigasept Instru AF) and incubate as appropriate. Then wipe with a cloth moistened with water and dry with paper towels. Return the objects to the drawers.

Clean adapters (optional)

1. Clean the removed adapters by soaking them in a glyoxal and quaternary ammonium salt based disinfectant (e.g., Gigasept Instru AF) according to the manufacturer's instructions. After incubation according to manufacturer's instructions, rinse the removed objects thoroughly with water.
2. We recommend storing the adapters at 4°C, so that they will be precooled and ready for use in the next assay run.

14.5.5 Conveyor base tray (SP) — optional

Clean the conveyor base tray (optional)

1. Carefully remove the conveyor base tray from below the magnetic head.
2. Soak in a glyoxal and quaternary ammonium salt based disinfectant (e.g., Gigasept Instru AF) for at least 15 minutes.
3. Rinse with water and wipe dry with paper towels.

Note: The tray can also be autoclaved at 121°C for 20 minutes.

14.5.6 Robotic gripper (SP)

Clean the robotic gripper

1. Wipe the robotic gripper with a lint-free cloth moistened with ethanol-based disinfectant (e.g., Mikrozyd). Incubate as appropriate.
2. Wipe with a lint-free cloth moistened with water and dry with paper towels.

Note: Only wipe the weight. Do not wipe the rods otherwise the ball mechanism may become jammed.

14.5.7 Liquid waste container (SP)

Clean the liquid waste container

1. Remove the liquid waste container from the "Waste" drawer.
2. Empty the liquid waste container. Dispose of the liquid waste according to your local safety regulations.
3. Clean the liquid waste container with a glyoxal and quaternary ammonium salt based disinfectant (e.g., Gigasept Instru AF) according to the manufacturer's instructions.
4. Rinse the liquid waste container with deionized water.
5. Replace the liquid waste container in the "Waste" drawer.

14.6 Weekly maintenance (SP/AS)

The underlined words are the keywords the user sees on the touchscreen within the maintenance scheduler (see "Displaying detailed steps for a maintenance task", page 176).

14.6.1 File management

Download files (SP/AS)

1. Download the result file(s) (for QIASymphony SP and QIASymphony AS) and loading information files (QIASymphony AS only) as described in Section 6.3 and ensure that the files are backed up.
2. Delete result files older than 10 days (default setting) as described in Section 6.6.

14.6.2 Touchscreen

Clean the touchscreen

Wipe the touchscreen with ethanol-based disinfectant (e.g., Mikrozyd). Then wipe with a cloth moistened with water and dry with paper towels.

14.6.3 QIASymphony SP/AS hoods

Clean the hoods

To clean the hoods of QIASymphony SP/AS instruments, wipe the surface with a soft lint-free cloth moistened with deionized water, or use wipes soaked with Mikrozyd Sensitive Liquid. Then wipe dry with a dry soft lint-free cloth or paper towel.

Note: Do not use ethanol-based disinfectant; use distilled water or Mikrozyd Sensitive Liquid only.

14.6.4 Tube carriers (SP)

Clean the tube carrier and inserts

1. Remove tube carriers, adapters, and inserts and soak them in disinfectant (e.g., Gigasept Instru AF). Incubate for at least 15 minutes, then rinse with water and dry with paper towels.
2. Check the condition of the bar code labels and ensure that they are not scratched.

14.6.5 Optical sensor (SP)

Clean the optical sensor

Wipe the window of the optical sensor with a lint-free cloth.

Moisten the cloth with 70% ethanol if required.

14.6.6 Magnetic head (SP)

Clean the magnetic head

1. Remove the cover from the magnetic head.
2. Move the magnetic head up and carefully push the rod cover holder down.

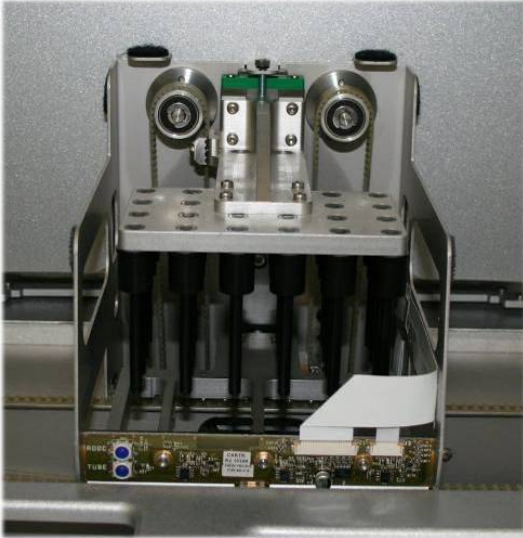

3. Wipe the exterior of the magnetic head with a lint-free cloth moistened with ethanol-based disinfectant (e.g., Mikrozid), and incubate as appropriate.
4. Wipe with a lint-free cloth moistened with water and dry with paper towels.

Note: Insert the cloth from the sides of the magnetic head in order not to damage the cable and electronic board at the front.

14.6.7 Liquid waste container (SP)

Clean the liquid waste container

1. Remove the liquid waste container from the "Waste" drawer.
2. Empty the liquid waste container. Dispose of the liquid waste according to your local safety regulations.
3. Disinfect the liquid waste container using ethanol-based disinfectant (e.g., Mikrozid).
4. Replace the liquid waste container in the "Waste" drawer.

14.6.8 Adapters (AS)

Clean adapters

1. Remove the adapters from the "Eluate and Reagents" and "Assays" drawers and soak them in disinfectant (e.g., Gigasept Instru AF). Incubate for at least 15 minutes.
2. Rinse with water and dry with paper towels.
3. Check the condition of the bar code labels and ensure that they are not scratched.

14.7 UV decontamination of the worktable

The underlined words are the keywords the user sees on the touchscreen within the maintenance scheduler (see “Displaying detailed steps for a maintenance task”, page 176).

UV decontamination

UV decontamination should be performed daily. It helps to reduce possible pathogen contamination of the QIASymphony SP/AS worktables. The efficiency of inactivation has to be determined for each specific organism and depends, for example, on layer thickness and sample type. QIAGEN cannot guarantee complete eradication of specific pathogens. UV decontamination of the QIASymphony SP and AS can be started either sequentially or in parallel.

Note: Before starting the UV irradiation procedure, ensure that all samples, eluates, reagents, consumables and assays have been removed from the worktable. Close all drawers and the hoods. Once the UV irradiation procedure has been started, it will continue for the defined period of time, or until interrupted by the user.

We recommend using the following formula to calculate the duration of decontamination in minutes:

$$\text{Dose (mW} \times \text{s/cm}^2\text{)} \times 10.44 = \text{Duration (seconds)}$$

1. Remove all removable objects (tubes/plates, adapters, consumables, tip disposal chute) except for the liquid waste bottle from the drawers.

A blue rectangular button with the text "Maintenance SP" in white.

2. Enter the **Maintenance** screen, and press **Maintenance SP** or **Maintenance AS**.

A blue rectangular button with the text "Maintenance AS" in white.

The **Maintenance AS** button is only available if you are using QIASymphony SP/AS instruments

A grey rectangular button with the text "Start UV light AS" in white.A grey rectangular button with the text "Start UV light SP" in white.A grey rectangular button with the text "Start UV light SP+AS" in white.

3. Press the **Start UV light AS** button, or the **Start UV light SP** button, or the **Start UV light SP+AS** button.

The **Input/UV cleanup/Duration** screen will open.

A light purple rectangular input box containing the number "15".

4. Enter the duration of the decontamination in minutes.
The default setting is 15 minutes. The UV irradiation time is dependent on the pathogen. Use the formula above to calculate the irradiation time and then enter the time into the input box.
A message appears asking you to check whether all plasticware and consumables have been removed from the worktable

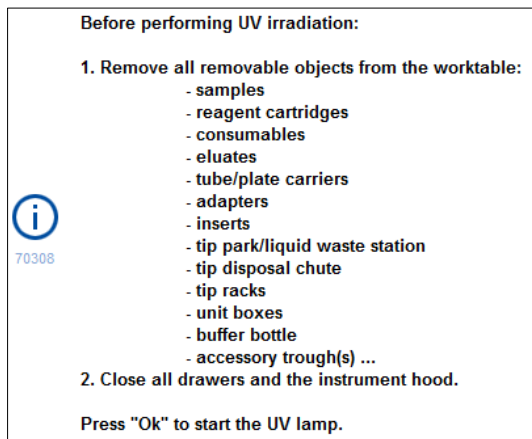

5. Confirm that all removable objects have been removed from the worktable by pressing **OK**.

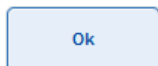

The UV irradiation procedure starts and the robotic arm moves over the worktable surface for the set irradiation duration.

Note: To stop the UV irradiation procedure before the defined period of time has elapsed, press **Cancel**. The procedure will stop as soon as the robotic arm completes the current movement.

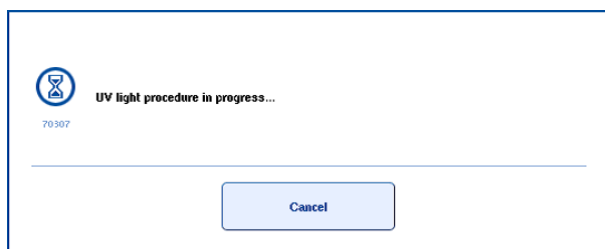

14.8 Monthly maintenance (SP/AS)

The underlined words are the keywords the user sees on the touchscreen within the maintenance scheduler (see "Displaying detailed steps for a maintenance task", page 176).

Change tip adapter O-ring

This section describes replacing the tip adapter O-ring using the O-Ring Change Tool Set (cat. no. 9019164) to perform O-ring change. The O-rings must be changed every month using the O-Ring Change Tool Set.

Before removing the old O-ring, the new O-ring must be prepared. These steps should be performed for both the QIAsymphony SP and the QIAsymphony AS instruments.

For instructions, refer to the quick guide that is equipped with the O-Ring Change Tool Set. If there is no O-Ring Change Tool Set available, contact QIAGEN Technical Services.

15 Technical Data

QIAGEN reserves the right to change specifications at any time.

15.1 Environmental conditions

Operating conditions

Power consumption QIAsymphony SP 100–240 V AC, 50/60 Hz, 800 VA

Power consumption QIAsymphony AS 100–240 V AC, 50/60 Hz, 600 VA

Mains supply voltage fluctuations are not to exceed 10% of nominal supply voltages. The inlet is on the QIAsymphony SP; in combined operation, the maximum power consumption is 1400 VA.

Overvoltage category II

Air temperature 15–32°C (59–89.6°F)

Relative humidity 15–75% (noncondensing)

Maximum 75% relative humidity for temperatures up to 31°C (88°F), decreasing linearly to 50% humidity at 32°C (89.6°F)

Altitude Up to 2000 m (6500 ft.)

Place of operation For indoor use only

Pollution level 2

Environmental class 3K2 (IEC 60721-3-3)
3M2 (IEC 60721-3-3)

Transportation conditions

Air temperature –25°C to 70°C (–13°F to 158°F) in manufacturer's package

Relative humidity Maximum of 75% (noncondensing)

Environmental class 2K2 (IEC 60721-3-2)
2M2 (IEC 60721-3-2)

Storage conditions

Air temperature 5°C to 40°C (41°F to 104°F) in manufacturer's package

Relative humidity Maximum of 85% (noncondensing)

Environmental class 1K2 (IEC 60721-3-1)
1M2 (IEC 60721-3-1)

15.2 Mechanical data and hardware features

QIASymphony SP

Dimensions	Width: 128 cm (50.4 in.) Height: 103 cm (40.6 in.) Depth: 73 cm (28.7 in.)
Weight	175 kg (385.8 lb.)

QIASymphony AS

Dimensions	Width: 59 cm (23.2 in.) Height: 103 cm (40.6 in.) Depth: 73 cm (28.7 in.)
Weight	90 kg (198 lb.)

QIASymphony SP and AS (integrated operation)

Dimensions	Width: 185 cm (72.8 in.) Height: 103 cm (40.6 in.) Depth: 73 cm (28.7 in.)
Weight	265 kg (584 lb.)

16 User Interface Addendum



This section provides an overview of the QIASymphony SP/AS user interface. The names of tabs, tools and buttons are displayed in alphabetical order. The availability of the software options is denoted using the following abbreviations:







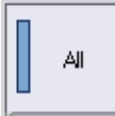
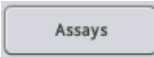
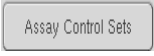

- AS = QIASymphony AS application
- SP = QIASymphony SP application
- IR = Integrated run (QIASymphony SP/AS) application
- TIs = Tools options for QIASymphony SP/AS



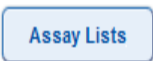







In addition, the name of each menu option is provided together with a description of the option. Several workflows may use the option, and workflow-specific descriptions are included.



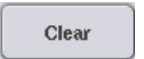







For detailed information about the user interface refer to the following:









- Section 3 of the *QIASymphony SP/AS User Manual – Operating the QIASymphony SP*
- Section 3 of the *QIASymphony SP/AS User Manual – Operating the QIASymphony AS*









Button	Availability		Menu option and description
	AS		Assay Specifications Enables addition of a custom control.
	SP	TIs	User Management/User Overview Enables creation of a new user account.
	AS	IR	Assay Assignment Shows all selected Assay Parameter Sets in the tab view.
	AS		Tools/Labware SP/AS Opens the Assays dialog panel. The assays that can be run with the selected item of labware are shown in a table (only visible if QIASymphony AS is installed).
		TIs	File transfer/Process Files Enables download/upload of Assay Control Set file(s).

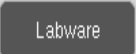

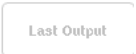

Button	Availability	Menu option and description
		Tls File transfer/Process Files Enables download/upload of Assay Definition file(s). Only visible when the QIAsymphony AS is installed.
	AS	Tls Tools Opens the Assay Favorites menu. Allows definition of assay favorites.
	AS	Assay Selection Displays the assay lists. The Assay Lists button is active when the screen is in the work lists mode.
	AS	IR Tls File transfer/Process Files Enables download/upload of Assay Parameter Set file(s). Only visible when the QIAsymphony AS is installed.
	AS	Assay Assignment Enables the user to assign an Assay Parameter Set that is selected in the tab in the slot 1, slot 2, or other view to the selected sample position(s). After an Assay Parameter Set is assigned to a sample, the color changes and the number of assigned Assay Parameter Sets appears.
	AS	Sample Rack(s)/Loading Information Enables generation of a rack ID (only for assay racks).
	AS SP	Integrated Setup/Sample Preparation Opens the previous screen.
		Tls File transfer/Process Files Press to transfer all protocols, assay control sets and, if QIAsymphony AS is installed, additional assay definitions, normalization definitions and assay parameter sets from QIAsymphony SP to USB stick.
	SP	Consumables/Cartridges/Filter-Tips Displays the “Keyboard” screen to enter or scan the bottle ID.



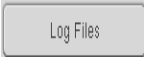

Button	Availability	Menu option and description
	AS SP IR Tls	Miscellaneous Cancels a completed workflow without saving the changes.
		Tls User Management Enables you to change your password.
		Tls User Management Enables the role of an existing user to be changed. This option is only available to the "Supervisor".
	AS SP	Sample Preparation/Sample ID/ Assay Setup Removes text from the text field.
	SP IR	Integrated Setup Deletes the assigned Assay Parameter Set(s) from selected sample position(s). Enables the user to clear positions and remove sample ID and sample type.
	SP	Consumables Switches back from the Sample Calculation to the Consumables view.
		Tls Tools Displays the Configuration menu. Only available for the "Supervisor".
		Tls Transfer files/In-/Output Files Enables download of start batch confirmation files.
	AS SP	Sample Preparation/Command bar/Assay Setup Continues the run. The Continue button appears if the current run is paused. After pausing, the samples of the processed batch will be flagged as "unclear". Note: A run should only be paused in case of an emergency.
		Tls Instrument Report Creates an instrument report file.





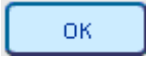

Button	Availability	Menu option and description
		Tls Transfer files/In-/Output Files Enables download of cycler file(s). Only visible when the QIA Symphony AS is installed.
	IR	Integrated Run Enables definition of an internal control. This button is active only when internal controls are loaded in a tube carrier.
	IR	Integrated Setup Opens the Assay Assignment screen.
	Tls	File transfer/In-/Output Files Deletes input and output files (except log files) that are older than a defined number of days. The default is 10 days and can be adjusted by QIAGEN Field Service Specialists upon request.
	IR	Integrated Setup Opens a message box that provides detailed information about the assigned assays and the integrated batch.
	AS IR	Assay Setup/Integrated Setup Enables the user to deselect all selected positions.
	IR	Integrated Setup Opens the "Sample Preparation/ Batch X/Define Samples" screen.
	SP	Sample Preparation/Internal Controls Displays the Internal controls list, enabling the user to assign the correct internal control to the selected position.
	AS SP	Define Samples/Sample Rack Layout Sets the sample type of the selected samples to EC+ (positive external control).
	AS SP	Define Samples/Sample Rack Layout Sets the sample type of the selected samples to EC- (negative external control).







Button	Availability	Menu option and description
		Tls Sample Preparation/Tools Opens the File transfer menu, enabling transfer of selected file types to the QIA Symphony SP/AS or to the USB stick.
		Tls Rack browser/Sample Racks Rack browser/Eluate Racks Rack browser/Assay Racks Enables the user to manually enter and then search for IDs using the Keyboard screen.
	SP	Sample Preparation Completes the Wizard . This button is only visible in the Wizard when the last batch has been defined and no internal control is required.
	SP IR	Sample Preparation/Integrated Setup Allows the user to assign a virtual ID to selected samples without bar codes. The virtual ID is displayed as: "PositionNumber on Tube Carrier_Unique Batch ID".
	AS SP IR Tls	Miscellaneous Provides information to help the user complete the current screen.
		Tls Instrument Report Displays the Instrument Report menu.
	SP IR	Sample Preparation/Integrated Setup Allows the user to edit sample IDs and sample types.
	SP IR	Sample Preparation/Integrated run Displays the Inserts/Tube types list. This enables the user to assign the correct tube type to the position.
		Tls Service SP/Service AS Allows the user to initialize the QIA Symphony instrument. After pressing the button, press Yes to initialize or No to cancel.







Button	Availability	Menu option and description
		Tls Labware browser/Labware SP Opens the "Input Racks" dialog panel and provides information about which sample racks can be used.
		Tls Labware browser/Labware AS Labware browser/Labware SP Opens the Labware dialog panel.
	SP	File transfer/Instr. Setup Files Enables download/upload of QIASymphony AS labware file(s).
		Tls Tools Opens the Labware Browser menu.
		Tls Instr. Setup Files Enables download/upload of the QIASymphony SP labware file(s).
		Tls Instr. Setup Files Press to upload new language packages.
		Tls Service SP/Service AS Opens script output. This button is enabled after an operator service script has been performed.
		Tls Rack browser/Sample Racks Rack browser/Eluate racks Rack browser/Assay Rack Displays the rack files that were modified between 00:00 of Monday last week and 00:00 of Monday of the current week.
	AS	Assay Setup/Loading Information Displays a screen that contains information about the assigned Assay Parameter Sets in a table.
	AS IR	Assay Setup/Loading Information Enables a reagent/normalization rack to be loaded. Press when loading the reagent/normalization rack. The system will check during the inventory scan whether reagent/normalization, sample, and assay racks were loaded correctly.

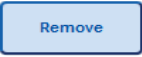
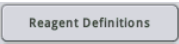

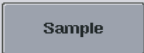



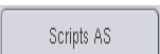
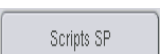

Button	Availability	Menu option and description
		Tls File Transfer/In-/Output Files Enables download of loading information file(s). Only visible when the QIAsymphony AS is installed.
		Tls File Transfer/In-/Output Files Enables download of system log file(s).
	AS	Tls Tools Switches to the assay setup user interface and displays the Maintenance AS menu for the QIAsymphony AS.
	AS SP	Tls Tools Displays the Maintenance SP menu.
	AS SP	Sample Preparation Assay Setup Saves changes and opens the next screen.
	SP	Sample Preparation Saves changes and opens the next screen. Becomes active if a sample slot containing a 24-well rack is selected or if a sample slot containing a 96-well rack has half/quarter of the positions selected. This button is available during the run definition process. The button becomes active when all necessary information for the current step is given.
	AS	Sample Rack Layout Saves changes and opens the next screen. Becomes active for each available "Sample" slot when at least one sample/EC+/EC- is assigned and all assigned positions have a defined volume.
	SP	General Buttons Opens the next screen in the workflow.
	AS	Assay Setup Defines a new assay run. Available when no assay run is currently defined.









Button	Availability	Menu option and description
		Tls File Transfer Ensures that selected files should not be synchronized when Transfer is pressed.
	AS IR	Assay Setup Saves changes and returns to the recent screen.
	AS SP IR	Assay Setup/Eluate Drawer Closes the screen.
	SP IR	Eluate Drawer Performs an inventory scan of the "Eluate" drawer to check the inventory of the "Eluate" drawer against the slot/rack assignment made in the Eluate Drawer/Elution Slot/Change Rack X screen.
	AS SP	Sample Racks/Eluate Racks/Assay Racks Displays the rack files that were modified before 00:00 of Monday last week.
		Tls Labware browser/Labware SP Opens the Output Racks dialog panel and provides information about which elution racks can be used.
	AS SP	Sample Preparation/Assay Setup Opens the assay setup Overview screen. This button is enabled when either the Sample View or Parameter View is open.
	SP	Sample Preparation Pauses the QIAsymphony SP. The Pause button should only be pressed in an emergency. After pressing Pause , the QIAsymphony SP completes the current command being processed, pauses the protocol, and changes the sample state to "unclear". If the protocol has been paused either by the user or due to an error, the Stop and Continue buttons appear.





Button	Availability	Menu option and description
	IR	<p>Command bar</p> <p>Pauses the QIASymphony AS. This button should only be pressed in case of an emergency. The QIASymphony AS completes the current command and then pauses the assay run. Samples will always be flagged as “unclear” if the run has been paused.</p>
	IR	<p>Command bar</p> <p>Pauses the QIASymphony SP. The Pause SP button should only be pressed in case of an emergency. The QIASymphony SP completes the current command being processed and then pauses the protocol. Samples will always be flagged as “unclear” if the run has been paused.</p>
	AS	<p>Assay Setup</p> <p>Opens the Parameter View screen. This screen displays information in a tabular format about Assay Parameter Sets and specifications for samples that will be processed, that are currently being processed, or that have been processed.</p>
	AS	<p>Assay Setup</p> <p>Opens the Plate View screen. This screen provides detailed loading information about the selected “Sample” or “Assay” slot.</p>
	Tls	<p>File Transfer/Instr. Setup Files</p> <p>Enables download of custom process configuration profiles.</p>
	Tls	<p>File transfer/Process Files</p> <p>Enables download/upload of protocol file(s).</p>

Button	Availability	Menu option and description
	AS	<p>Assay Setup</p> <p>Saves changes and opens the Loading Information screen. The button is active for all Assay Parameter Sets when at least one position is assigned.</p>
	SP	<p>Sample Preparation</p> <p>Opens the Sample Preparation/ Batch X screen. The Next button becomes active if a sample slot containing a 24-well rack is selected or if a sample slot containing a 96-well rack has half/quarter of the positions selected.</p>
	AS SP	<p>Tls Miscellaneous</p> <p>Displays the available sample rack types in the control panel.</p>
		<p>Tls Miscellaneous</p> <p>Displays the Rack Browser menu for viewing rack files saved on the QIA Symphony SP/AS instrument.</p>
	AS SP	<p>Assay Setup/Sample Preparation</p> <p>Displays the available rack files in the control panel.</p>
		<p>Tls File Transfer/In-/Output Files</p> <p>Enables upload/download of the rack file(s).</p>
	AS SP	<p>Assay Setup/Eluate Drawer</p> <p>Enables a rack ID to be scanned or manually entered.</p>
	AS	<p>Assay Setup</p> <p>Displays the rack type list.</p>
	AS SP	<p>Loading Information/Loading Reagents</p> <p>Enables a reagent/normalization rack to be removed. Press when unloading the reagent/normalization rack. The system will check during the inventory scan whether the rack was unloaded correctly.</p>
		<p>Tls Files transfer/Instr. Setup Files</p> <p>Enables upload/download of new reagent cartridge information.</p>

Button	Availability	Menu option and description
	AS	Labware browser/Labware AS Opens the Reagent Holders view in which information about reagent holders is displayed.
	AS IR	Sample Rack Layout Sets the sample type of the selected samples to "Sample".
	SP	Consumables Cartridges Opens the Sample Calculation dialog panel.
	AS	Assay Setup Allows the user to edit the IDs of the selected position(s) on the rack grid. When the button is pressed, the Manual Input screen appears.
	AS SP IR	Sample Preparation/Eluate Drawer/Integrated Setup Displays the Keyboard screen, enabling the user to manually enter sample IDs.
	AS SP	Overview Opens the Sample View screen. This screen displays information in a tabular format.
	Tls	User Management Saves changes.
	AS	Assay Setup Enables the user to enter a kit bar code. Press the field. You can enter a bar code in the screen that appears.
	Tls	File Transfer/Instr. Setup Files Enables upload/download of operator service scripts for the QIAAsymphony AS.
	Tls	File Transfer/Instr. Setup Files Enables upload/download of operator service scripts for the QIAAsymphony SP.

Button	Availability	Menu option and description
	SP IR	Integrated Setup/Sample Preparation Enables the user to select all samples.
	SP	Sample Preparation Selects all internal control positions.
	AS	Assay Setup Selects all positions. Only available when no position on the rack is selected. Otherwise, the Deselect All button is enabled.
		Tls Tools Opens the Service AS menu under which special service functions (e.g., for maintenance or instrument re-initialization) can be initiated.
		Tls Tools/Sample Preparation Opens the Service SP menu under which special service functions (e.g., for maintenance or instrument re-initialization) can be initiated.
	AS IR	Assay Assignment Opens the Assay Specifications screen.
		Tls Tools Starts the selected operator service script.
	SP	Sample Preparation Stops the run. The Stop button appears if the current run is paused.
	IR	Command bar Stops the AS run. The Stop AS button appears if the current assay run is paused.
	IR	Command bar Stops the SP run. The Stop SP button appears if the current run is paused.

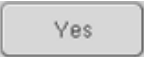
Button	Availability	Menu option and description
	AS SP	<p>R&C Drawer W Drawer E Drawer E & R Drawer A Drawer</p> <p>Stops the inventory scan of the “Eluate” drawer that is in progress, and then opens the previous screen.</p>
		<p>Tls Rack browser/Sample Racks Rack browser/Eluate Racks Rack browser/Assay Rack</p> <p>Displays the rack files that have been modified since 00:00 of Monday of the current week, including the rack files that were modified today. This option is preselected by default.</p>
		<p>Tls Rack browser/Sample Racks Rack browser/Eluate Racks Rack browser/Assay Rack</p> <p>Displays the rack files that were modified today.</p>
		<p>Tls Maintenance SP</p> <p>Opens/returns to the Tools menu.</p>
	SP	<p>File transfer/Instr. Setup Files File transfer/Process Files File transfer/In-/Output Files</p> <p>Enables transfer of selected file types to the QIA Symphony SP/AS or to the USB stick.</p>
	SP	<p>Labware SP</p> <p>Opens the Tube Carrier screen.</p>
	SP	<p>Tls Integrated Setup/Sample Preparation</p> <p>Enables the user to change the tube type.</p>
		<p>Tls Instr. Setup Files</p> <p>Saves information about all created users to a USB stick. Press to download the Assay Control Set file(s).</p>
		<p>Tls Tools/Sample Preparation</p> <p>Opens the User Management menu for managing users and passwords.</p>

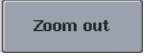
Button	Availability	Menu option and description
	AS	Assay Setup Allows the user to edit the volume of the selected position(s) on the rack grid.
	SP	Sample Preparation Starts the Wizard .
	Tls	File Transfer/In-/Output Files Enables upload of work list(s).
	AS	Assay Setup Switches to the work list mode. If at least one work list is available for the samples and the screen is in the manual mode, the Work Lists button is active.
	Tls	File Transfer/In-/Output Files Enables selected files to be synchronized when Transfer is pressed.
	AS	Assay Setup Enables the user to magnify the rack grid view to display additional information.
	AS	Assay Setup Enables the user to return to the normal view after zooming in.

Appendix

Declaration of Conformity

Declaration of conformity – QIASymphony SP

Name and address of legal manufacturer

**QIAGEN GmbH
QIAGEN Strasse 1
40724 Hilden
Germany**

An up-to-date Declaration of Conformity can be requested from QIAGEN Technical Services.

Declaration of conformity – QIASymphony AS

Name and address of legal manufacturer

**QIAGEN GmbH
QIAGEN Strasse 1
40724 Hilden
Germany**

An up-to-date Declaration of Conformity can be requested from QIAGEN Technical Services.

Waste Electrical and Electronic Equipment (WEEE)

This section provides information about disposal of waste electrical and electronic equipment by users.

The crossed-out wheeled bin symbol (see below) indicates that this product must not be disposed of with other waste; it must be taken to an approved treatment facility or to a designated collection point for recycling, according to local laws and regulations.

The separate collection and recycling of waste electronic equipment at the time of disposal helps to conserve natural resources and ensures that the product is recycled in a manner that protects human health and the environment.



Recycling can be provided by QIAGEN upon request at additional cost. In the European Union, in accordance with the specific WEEE recycling requirements and where a replacement product is being supplied by QIAGEN, free recycling of its WEEE-marked electronic equipment is provided.

To recycle electronic equipment, contact your local QIAGEN sales office for the required return form. Once the form is submitted, you will be contacted by QIAGEN either to request follow-up information for scheduling collection of the electronic waste or to provide you with an individual quote.

FCC declaration

The “United States Federal Communications Commission” (USFCC) (in 47 CFR 15. 105) declared that the users of this product must be informed of the following facts and circumstances.

“This device complies with part 15 of the FCC:

Operation is subject to the following two conditions: (1) This device may not cause harmful interference, and (2) this device must accept any interference received, including interference that may cause undesired operation.”

“This Class A digital apparatus complies with Canadian ICES-0003.”

The following statement applies to the products covered in this consolidated operating guide, unless otherwise specified herein. The statement for other products will appear in the accompanying documentation.

Note: This equipment has been tested and found to comply with the limits for a Class A digital device, pursuant to part 15 of the FCC Rules. These limits are designed to provide reasonable protection against harmful interference when the equipment is operated in a commercial environment. This equipment generates, uses, and can radiate radio frequency energy and, if not installed and used in accordance with the instruction manual, may cause harmful interference to radio communications. Operation of this equipment in a residential area is likely to cause harmful interference in which case the user will be required to correct the interference at his own expense.

QIAGEN GmbH Germany is not responsible for any radio television interference caused by unauthorized modifications of this equipment or the substitution or attachment of connection cables and equipment other than those specified by QIAGEN GmbH, Germany. The correction of interference caused by such unauthorized modification, substitution, or attachment will be the responsibility of the user.

Liability clause

QIAGEN shall be released from all obligations under its warranty in the event repairs or modifications are made by persons other than its own personnel, except in cases where the Company has given its written consent to perform such repairs or modifications.

All materials replaced under this warranty will be warranted only for the duration of the original warranty period, and in no case beyond the original expiration date of original warranty unless authorized in writing by an officer of the Company. Read-out devices, interfacing devices, and associated software will be warranted only for the period offered by the original manufacturer of these products. Representations and warranties made by any person, including representatives of QIAGEN, which are inconsistent or in conflict with the conditions in this warranty shall not be binding upon the Company unless produced in writing and approved by an officer of QIAGEN.

Index

- Accessories, 13
- Accessory trough, 73
- Assay Control Sets
 - assigning to samples, 90
- Assay favorites, 102
- Assay Parameter Sets, 136
- Assay parameters
 - modifying, 140
- Assay racks
 - assigning, 115
 - assigning assay rack IDs, 117
 - assigning rack types, 116
 - defining, 114
 - loading, 143
- Assay run
 - defining an assay run, 127
 - defining assays, 135
 - queuing an assay run, 141
 - removing assays, 124, 145
 - validating, 142
- Assays drawer QIASymphony AS, 99
- Bar codes
 - customized kit bar codes, 121
 - entering reagent kit bar codes, 120
 - reader, 53
 - scanner, 54
 - types, 54
 - virtual, 89
- Cabinet, 13
- Cautions, 14
- Cooling temperatures, 122, 144
- Declaration of conformity, 206
- Drawer buttons, 39
- Eluate and Reagents drawer QIASymphony AS, 98
- Elution racks, 61
- Environmental conditions, 190
- Error messages and warnings, 153
- Error record, 157
- Files
 - deleting, 48
 - handling, 42
 - synchronizing, 46
 - transfer, 42
- Filter-tips
 - loading, 121
- Independent operation, 100
- Independent run, 127
- Installation
 - site requirements, 25
- Instrument report file, 158
- Integrated operation, 101
- Integrated run, 103
 - loading, 112
 - pausing, resuming, and stopping, 125
 - starting, 123
- Intended use, 11
 - users, 12
- Inventory scan
 - Eluate drawer, 85
 - Reagents and Consumables drawer, 83
 - Waste drawer, 85
- Inventory scan QIASymphony AS, 150
- Language
 - changing the language, 36
 - changing the QMC language, 37
 - language package installation, 35
- Loading
 - assay racks, 143
 - filter-tips, 121
 - reagents, 118
- Loading an independent run, 142
- Loading Eluate drawer, 60
- Loading information
 - viewing, 118
- Loading information file, 142
- Loading internal controls, 79
- Loading Reagents and Consumables drawer, 67
- Loading Sample drawer, 75
- Loading Waste drawer, 56
- Logging out, 28
- Maintenance
 - cleaning agents, 178
 - daily, 182
 - O-ring, 189
 - regular, 179
 - scheduler, 174
 - UV decontamination, 188
 - weekly, 185
- Mechanical data and hardware features, 191
- Normalization, 101
- Operating conditions, 190

- Password change
 - system request, 32
 - user request, 34
- Pausing, resuming, and stopping an independent run, 149
- Pausing, resuming, and stopping an integrated run, 125
- QIASymphony AS
 - external features, 96
 - principle, 95
- QIASymphony SP
 - features, 50
 - principle, 50
 - Wizard, 55
- Queuing a run, 141
- Rack files
 - assigning a rack file, 130
- Reagents
 - loading, 118
- Removing assays, 124, 145
- Rotor-Disc, 114
- Run
 - pausing, 86, 125
 - resuming, 87, 126
 - stopping, 87, 126
- Safety
 - biological, 17
 - chemicals, 17
 - electrical, 15
 - environment, 16
 - heat hazard, 19
 - maintenance, 19
 - mechanical hazards, 18
 - proper use, 14
 - toxic fumes, 18
 - waste disposal, 16
- Sample drawer
 - unloading sample tubes, 79
- Sample racks, 127, 131
 - assigning sample rack IDs, 128
 - defining/checking sample racks, 131
- Sample slots, 127
- Sample tubes, 75
- Samples
 - Assay Control Sets, 90
 - configuring sample type, 89
 - defining/queuing, 90
 - removing a batch, 79
 - viewing/editing sample IDs, 134
 - volumes, 133
- Servicing, 179
- Standard curve, 102
- Starting an independent run, 144
- Starting an integrated run, 123
- Startup, 27
- Storage conditions, 190
- Switching off, 29
- Symbols
 - safety, 21
 - software, 41
- Tab menus, 40
- Technical assistance, 10
- Tip disposal bag, 58
- Training, 12
- Transportation conditions, 190
- Troubleshooting, 153
 - assay definition AS, 170
 - data analysis AS, 172
 - during an assay run AS, 171
 - Eluate drawer, 166
 - error messages, warnings, 153
 - errors starting a run, 168
 - general errors, 159
 - general operation, 168
 - integrated run errors, 172
 - inventory scan, 164
 - protocol errors, 168
 - protocol interruption, 169
 - Reagents and Consumables drawer, 167
 - Sample drawer, 167
 - Waste drawer, 167
- Unloading Eluate drawer, 65
- Unloading internal controls, 82
- Unloading Reagents and Consumables drawer, 73
- Unloading the worktable, 147
- USB stick
 - data transfer, 43
 - synchronizing files, 46
 - transferring files, 45
- Users
 - accounts, 32
 - create new users, 31
 - settings, 30
- Validation, 142
- Ventilation, 16, 25
- View loading information, 118
- Warnings, 14
- Waste disposal, 16, 207
- Wizard, 55

This page intentionally left blank

Trademarks: QIAGEN[®], Sample to Insight[™], QIASymphony[®], Rotor-Disc[®], Rotor-Gene[®] (QIAGEN Group); DECON-QUAT[®] (Vellek Associates, Inc.); DNA-ExitusPlus[™] (Applichem GmbH); Excel[®], Microsoft[®], Windows[®] (Microsoft Corporation); Gigasept[®], MikroZid[®] (Schülke & Mayr GmbH); Incidin[®] (Ecolab, Inc.); LightCycler[®] (Roche Group); Sarstedt[®] (Sarstedt AG and Co.).
Registered names, trademarks, etc. used in this document, even when not specifically marked as such, are not to be considered unprotected by law.
May-18 HB-2382-001 1107307 157027878 © 2012–2018 QIAGEN, all rights reserved .

