

January 2021

QIAstat-Dx[®] Analyzer 1.0 User Manual



Revision 3 For use with software version 1.4.x or higher

IVD

CE

REF

9002824 (QIAstat-Dx Analyzer 1.0, complete system)

REF

9002814 (QIAstat-Dx Analytical Module)

REF

9002813 (QIAstat-Dx Operational Module)



QIAGEN GmbH, QIAGEN Strasse 1, D-40724 Hilden

Contents

1	Introduction	6
1.1	About this user manual	6
1.2	General information.....	7
1.2.1	Technical assistance.....	7
1.2.2	Policy statement.....	7
1.3	Intended use of the QIAstat-Dx Analyzer 1.0	8
1.3.1	Limitations of use	8
2	Safety Information	9
2.1	Proper use	10
2.2	QIAstat-Dx Analyzer 1.0 transport precautions.....	11
2.3	Electrical safety	11
2.4	Chemical safety.....	11
2.5	Biological safety.....	12
2.6	Waste disposal	13
2.7	Symbols on the QIAstat-Dx Analyzer 1.0.....	14
2.8	Data security.....	15
3	General Description	16
3.1	System description.....	16
3.2	QIAstat-Dx Analyzer 1.0 description.....	16
3.3	QIAstat-Dx assay cartridge description.....	18
3.4	QIAstat-Dx Analyzer software	19
4	Installation Procedures	20
4.1	Site requirements.....	20
4.2	QIAstat-Dx Analyzer 1.0 delivery and components.....	21
4.3	Unpacking and installing the QIAstat-Dx Analyzer 1.0.....	23
4.4	Installing additional Analytical Modules	27
4.5	Repackaging and shipping the QIAstat-Dx Analyzer 1.0.....	32
5	Running a Test and Viewing Results	34
5.1	Starting the QIAstat-Dx Analyzer 1.0	34

5.2	Preparing the QIAstat-Dx assay cartridge	34
5.3	Procedure to run a test	35
5.3.1	Canceling a test run.....	41
5.4	Viewing results.....	42
5.4.1	Viewing amplification curves	43
5.4.2	Viewing melting curves.....	45
5.4.3	Viewing test details.....	46
5.4.4	Browsing results from previous tests	47
5.4.5	Exporting results to a USB drive.....	50
5.4.6	Printing results.....	50
5.4.7	Creating a support package	50
6	System Functions and Options	52
6.1	Main screen.....	52
6.1.1	General status bar	53
6.1.2	Module status bar	53
6.1.3	Module status page	54
6.1.4	Main Menu bar	55
6.1.5	Content area.....	55
6.2	Login screen.....	56
6.2.1	Logging out	58
6.3	Screen saver	58
6.4	Options menu	59
6.5	Archive results.....	59
6.5.1	Create archive	60
6.5.2	Open archive.....	61
6.6	User management	62
6.6.1	Accessing and managing the list of users	63
6.6.2	Adding users.....	66
6.7	Assay management	68
6.7.1	Managing available assays.....	68
6.7.2	Creating an epidemiology report.....	69

6.7.3	Importing new assays.....	70
6.8	Configuring the QIAstat-Dx Analyzer 1.0	71
6.8.1	Regional settings	71
6.8.2	HIS/LIS settings	74
6.8.3	QIASphere Base settings.....	74
6.8.4	General settings	76
6.8.5	Printer settings.....	77
6.8.6	Network settings.....	77
6.8.7	Network Share.....	79
6.8.8	System log.....	80
6.8.9	Version information and software license agreement.....	81
6.8.10	System update.....	81
6.8.11	System backup	82
6.9	Change passwords.....	83
6.10	QIAstat-Dx Analyzer 1.0 system status	85
6.11	Shutting down the QIAstat-Dx Analyzer 1.0.....	85
7	HIS/LIS Connectivity	86
7.1	Activating and configuring communication with the HIS/LIS.....	86
7.2	Assay name configuration	87
7.3	Creating a test order with host connectivity.....	88
7.3.1	Configuration of the QIAstat-Dx Analyzer 1.0 with host connectivity.....	88
7.3.2	Running a test based on a test order	88
7.4	Uploading a test result to the host.....	91
7.4.1	Uploading a test result automatically to the host	91
7.4.2	Configuration of QIAstat-Dx Analyzer 1.0 for uploading a test result manually to the host	92
7.4.3	Uploading a test result manually to the host	93
7.5	Troubleshooting host connectivity.....	93
8	Maintenance	94
8.1	Maintenance tasks.....	94
8.2	Cleaning the QIAstat-Dx Analyzer 1.0 surface	94

8.3	Decontaminating the QIAstat-Dx Analyzer 1.0 surface	95
8.4	Replacing the air filter	96
8.5	QIAstat-Dx Analyzer 1.0 repair	97
9	Troubleshooting	98
9.1	Hardware and software errors	98
9.2	Errors and warning messages	100
10	Technical Specifications	103
11	Appendices	104
11.1	Printer installation and configuration	104
11.1.1	Printer installation via USB	104
11.1.2	Printer installation via Ethernet	104
11.1.3	CUPS printer driver installation	105
11.1.4	List of tested printers	108
11.2	Declaration of Conformity	109
11.3	Waste Electrical and Electronic Equipment (WEEE)	110
11.4	Liability clause	111
11.5	Software License Agreement	112
11.6	Disclaimer of warranties	116
11.7	Glossary	117
INDEX	118
Document Revision History	121

A printed version of this manual is available upon request.

1 Introduction

Thank you for choosing the QIAstat-Dx® Analyzer 1.0. We are confident that this system will become an integral part of your laboratory.

This manual describes how to operate the QIAstat-Dx Analyzer 1.0 with software version 1.4 or higher. Before using the QIAstat-Dx Analyzer 1.0, it is essential that you read this user manual carefully and pay particular attention to the safety information. The instructions and safety information in the user manual must be followed to ensure safe operation of the instrument and to maintain the instrument in a safe condition.

Note: The figures shown in this user manual are only examples and may differ from assay to assay.

1.1 About this user manual

This user manual provides information about the QIAstat-Dx Analyzer 1.0 in the following sections:

- Introduction
- Safety Information
- General Description
- Installation Procedures
- Running a Test and Viewing Results
- System Functions and Options
- HIS/LIS Connectivity
- Maintenance
- Troubleshooting
- Technical Specifications

The appendices contain the following information:

- Printer installation and configuration, including a list of tested printers
- Declaration of Conformity
- Waste Electrical and Electronic Equipment (WEEE)
- Liability Clause
- Software License Agreement
- Disclaimer of warranties
- Glossary

1.2 General information

1.2.1 Technical assistance

At QIAGEN, we pride ourselves on the quality and availability of our technical support. Our Technical Services Departments are staffed by experienced scientists with extensive practical and theoretical expertise in molecular biology and the use of QIAGEN products. If you have any questions or experience any difficulties regarding the QIAstat-Dx Analyzer 1.0 or QIAGEN products in general, do not hesitate to contact us.

QIAGEN customers are a major source of information regarding advanced or specialized uses of our products. This information is helpful to other scientists as well as to the researchers at QIAGEN. We therefore encourage you to contact us if you have any suggestions about product performance or new applications and techniques.

For technical assistance, contact QIAGEN Technical Services at support.qiagen.com.

When contacting QIAGEN Technical Services about errors, please have the following information ready:

- QIAstat-Dx Analyzer 1.0 serial number, type, software version, and installed **Assay Definition Files**
- Error code (if applicable)
- Timepoint when the error occurred for the first time
- Frequency of error occurrence (i.e., intermittent or persistent error)
- Photo of error, if possible
- Support package

1.2.2 Policy statement

It is the policy of QIAGEN to improve products as new techniques and components become available. QIAGEN reserves the right to change specifications at any time. In an effort to produce useful and appropriate documentation, we appreciate your comments on this user manual. Please contact QIAGEN Technical Services.

1.3 Intended use of the QIAstat-Dx Analyzer 1.0

The QIAstat-Dx Analyzer 1.0 is intended for in vitro diagnostic use and provides diagnostic results. All analytical steps are fully automated using molecular diagnostic QIAstat-Dx cartridges and real-time PCR detection.

The QIAstat-Dx Analyzer 1.0 system is intended for professional use only and is not intended for self-testing.

1.3.1 Limitations of use

- The QIAstat-Dx Analyzer 1.0 can only be used with QIAstat-Dx assay cartridges according to the instructions contained in this user manual and in the QIAstat-Dx assay cartridge instructions for use.
- When connecting the QIAstat-Dx Analyzer 1.0, use only the cables supplied with the system.
- Any service or repairs should be performed only by personnel authorized by QIAGEN.
- The QIAstat-Dx Analyzer 1.0 should only be operated on a flat, horizontal surface with no angles or tilts.
- Do not re-run a QIAstat-Dx assay cartridge if it has already been used successfully, or if it has been associated with an error or an incomplete run.
- Allow at least 10 cm clearance on each side of the QIAstat-Dx Analyzer 1.0 to ensure adequate ventilation.
- Make sure that the QIAstat-Dx Analyzer 1.0 is positioned away from any air conditioning outlets or heat exchangers.
- Do not move the instrument while a test is running.
- Do not change the system configuration during a run.
- Do not use the touchscreen to lift or move the QIAstat-Dx Analyzer 1.0.

2 Safety Information

Before using the QIAstat-Dx Analyzer 1.0, it is essential that you read this user manual carefully and pay particular attention to the safety information. The instructions and safety information in the user manual must be followed to ensure safe operation of the instrument and to maintain the instrument in a safe condition.

Possible hazards that could harm the user or result in damage to the instrument are clearly stated at the appropriate places throughout this user manual.

If the equipment is used in a manner not specified by the manufacturer, the protection provided by the equipment may be impaired.

The following types of safety information appear throughout the *QIAstat-Dx Analyzer 1.0 User Manual*.

WARNING 	The term WARNING is used to inform you about situations that could result in personal injury to you or others. Details about these circumstances are given in a box like this one.
---	---

CAUTION 	The term CAUTION is used to inform you about situations that could result in damage to an instrument or other equipment. Details about these circumstances are given in a box like this one.
---	---

IMPORTANT	The term IMPORTANT is used to highlight information that is critical for the completion of a task or optimal performance of the system.
------------------	--

Note	The term Note is used for information that explains or clarifies a specific case or task.
-------------	--

The guidance provided in this manual is intended to supplement, not supersede, the normal safety requirements prevailing in the user's country.

2.1 Proper use

Use the QIAstat-Dx Analyzer 1.0 according to this user manual. It is highly recommended to carefully read and become acquainted with the instructions for use before using the QIAstat-Dx Analyzer 1.0.

- Follow all safety instructions printed on, or attached to, the QIAstat-Dx Analyzer 1.0.
- Improper use of the QIAstat-Dx Analyzer 1.0, or failure to comply with its proper installation and maintenance, may cause personal injuries or damage to the QIAstat-Dx Analyzer 1.0.
- The QIAstat-Dx Analyzer 1.0 must only be operated by qualified and appropriately trained healthcare personnel.
- Servicing of the QIAstat-Dx Analyzer 1.0 must only be performed by representatives authorized by QIAGEN.
- Do not use the QIAstat-Dx Analyzer 1.0 in hazardous environments for which it has not been designed.
- Follow your organization's cybersecurity policies for credential custody.

<p>WARNING/ CAUTION</p> 	<p>Risk of personal injury and material damage</p> <p>Do not open the housing of the QIAstat-Dx Analyzer 1.0. The housing of the QIAstat-Dx Analyzer 1.0 is designed to protect the operator and to ensure proper operation of the QIAstat-Dx Analyzer 1.0. Using the QIAstat-Dx Analyzer 1.0 without the housing leads to electrical hazards and QIAstat-Dx Analyzer 1.0 malfunction.</p>
--	---

<p>WARNING/ CAUTION</p> 	<p>Risk of personal injury and material damage</p> <p>Use caution when the lid of the cartridge entrance port closes to avoid personal injury, such as pinched fingers.</p>
--	--

2.2 QIAstat-Dx Analyzer 1.0 transport precautions

<p>WARNING/ CAUTION</p> 	<p>Risk of personal injury and material damage</p> <p>The QIAstat-Dx Analyzer 1.0 is a heavy instrument. To avoid personal injury or damage to the QIAstat-Dx Analyzer 1.0, take care when lifting it and use appropriate lifting methods.</p>
--	---

2.3 Electrical safety

Observe all general safety precautions that apply to electrical instruments.

Disconnect the line power cord from the power outlet before servicing.

<p>WARNING</p> 	<p>Electrical hazard</p> <p>Lethal voltages inside the QIAstat-Dx Analyzer 1.0. Do not open the housing of the QIAstat-Dx Analyzer 1.0.</p> <p>The line power cord must be connected to a line power outlet that has a protective conductor (earth/ground).</p> <p>Do not touch any switches or power cords with wet hands.</p> <p>Do not use the instrument outside of the specified power conditions.</p>
---	--

2.4 Chemical safety

Safety Data Sheets (SDSs) for the cartridge materials are available and can be requested from QIAGEN.

Used QIAstat-Dx assay cartridges must be disposed of in accordance with all national, state, and local health and safety regulations and laws.

WARNING 	Hazardous chemicals Chemicals may leak from the cartridge in the event that the cartridge housing is damaged. Some chemicals used in QIAstat-Dx assay cartridges may be hazardous or may become hazardous. Always wear eye protection, gloves, and a lab coat.
---	--

CAUTION 	Risk of damage to the QIAstat-Dx Analyzer 1.0 Avoid spilling chemicals or other liquids into or out of the QIAstat-Dx Analyzer 1.0. Damage caused by liquid spillage will void the warranty.
---	--

2.5 Biological safety

The QIAstat-Dx Analyzer 1.0 and cartridges do not themselves contain biohazardous materials. However, samples and reagents containing materials from biological sources should generally be handled and disposed of as potentially biohazardous. Use safe laboratory procedures as outlined in publications such as *Biosafety in Microbiological and Biomedical Laboratories*, from the Centers for Disease Control and Prevention and the National Institutes of Health (www.cdc.gov/od/ohs/biosfty/biosfty.htm).

Samples tested on the QIAstat-Dx Analyzer 1.0 may contain infectious agents. Users should be aware of the health hazard presented by such agents and should use, store, and dispose of such samples according to the required safety regulations. Wear personal protective equipment and disposable powder-free gloves when handling reagents or samples, and wash hands thoroughly thereafter.

Always observe safety precautions as outlined in relevant guidelines, such as the Clinical and Laboratory Standards Institute® (CLSI) *Protection of Laboratory Workers from Occupationally Acquired Infections, Approved Guidelines (M29)*, or other appropriate documents provided by:

- OSHA®: Occupational Safety and Health Administration (United States of America)
- ACGIH®: American Conference of Government Industrial Hygienists (United States of America)
- COSHH: Control of Substances Hazardous to Health (United Kingdom)

Avoid contamination of the QIAstat-Dx Analyzer 1.0 and workspace by handling samples and QIAstat-Dx assay cartridges with care. In the event of contamination (e.g., a leak from a cartridge), clean and decontaminate the affected area and the QIAstat-Dx Analyzer (see Section 8).

<p>WARNING</p> 	<p>Biological hazard</p> <p>Use caution when loading or removing QIAstat-Dx assay cartridges containing infectious samples into or from the QIAstat-Dx Analyzer 1.0. A break in the cartridge could contaminate the QIAstat-Dx Analyzer 1.0 and the surrounding area.</p> <p>All QIAstat-Dx assay cartridges should be handled as if they contain potentially infectious agents.</p>
---	---

<p>CAUTION</p> 	<p>Risk of contamination</p> <p>Contain and clean contamination from a broken or visibly damaged QIAstat-Dx assay cartridge immediately. Contents, though not infectious, can be spread by normal activity and may contaminate further analytical results, leading to false positives.</p>
---	---

For instructions on cleaning and decontaminating the QIAstat-Dx Analyzer 1.0, refer to Section 8.2 and 8.3, respectively.











2.6 Waste disposal

Used QIAstat-Dx assay cartridges and plasticware may contain hazardous chemicals or infectious agents. Such waste must be collected and disposed of properly in accordance with all national, state, and local health and safety regulations and laws.

For disposal of waste electrical and electronic equipment (WEEE), see Appendix 11.4.

2.7 Symbols on the QIAstat-Dx Analyzer 1.0

The following symbols appear on the QIAstat-Dx Analyzer 1.0 instrument and/or QIAstat-Dx assay cartridges.

Symbol	Location	Description
	Type plate on the back of the instrument	CE mark for Europe
	Type plate on the back of the instrument	TÜV mark of the TÜV SÜD Product Service for testing
	Type plate on the back of the instrument	CB mark of the IECEE member states
	Type plate on the back of the instrument	RoHS mark for China (the restriction of the use of certain hazardous substances in electrical and electronic equipment)
	Type plate on the back of the instrument	CAUTION Hazard – risk of personal injury and material damage
	Type plate on the back of the instrument	WEEE mark for Europe
	Type plate on the back of the instrument	Legal manufacturer
	Type plate on the back of the instrument	In vitro diagnostic medical device
	Type plate on the back of the instrument	Catalog number
	Type plate on the back of the instrument	Serial number

2.8 Data security

Note: It is strongly recommended to perform regular system backups according to your organization's policy for the availability of data and the protection of data from loss.

The QIAstat-Dx Analyzer is delivered with a USB storage device, which should preferably be used for short-term data storage and general data transfer (e.g., saving results, system backup and archive creations, system updates, or Assay Definition File imports).

Note: The use of a USB storage device is subject to restrictions (e.g. the memory capacity or the risk of overwriting, which should be considered before usage.)

For long-term data security, follow your organization's data storage and security policies for credential retention.

3 General Description

3.1 System description

The QIAstat-Dx Analyzer 1.0, in combination with QIAstat-Dx assay cartridges, uses real-time PCR to detect pathogen nucleic acids in human biological samples. The QIAstat-Dx Analyzer 1.0 and cartridges are designed as a closed system that enables hands-off sample preparation followed by detection and identification of pathogen nucleic acids. Samples are inserted into a QIAstat-Dx assay cartridge that contains all reagents necessary to isolate and amplify nucleic acids from the sample. Detected real-time amplification signals are interpreted by the integrated software and are reported via an intuitive user interface.

3.2 QIAstat-Dx Analyzer 1.0 description

The QIAstat-Dx Analyzer 1.0 consists of an Operational Module and 1 or more (as many as 4) Analytical Modules. The Operational Module includes elements that provide connectivity to the Analytical Module and enable user interaction with the QIAstat-Dx Analyzer 1.0. The Analytical Module contains the hardware and software for sample testing and analysis.

The QIAstat-Dx Analyzer 1.0 includes the following elements:

- Touchscreen for user interaction with the QIAstat-Dx Analyzer 1.0
- Bar code reader for sample, patient, user, and QIAstat-Dx assay cartridge identification
- USB ports for assay and system upgrades, document export and printer connectivity (one in front, three in back)
- Cartridge entrance port for inserting QIAstat-Dx assay cartridges into the QIAstat-Dx Analyzer 1.0
- Ethernet connector for network connectivity

Figure 1 and Figure 2 show the locations of various QIAstat-Dx Analyzer 1.0 features.

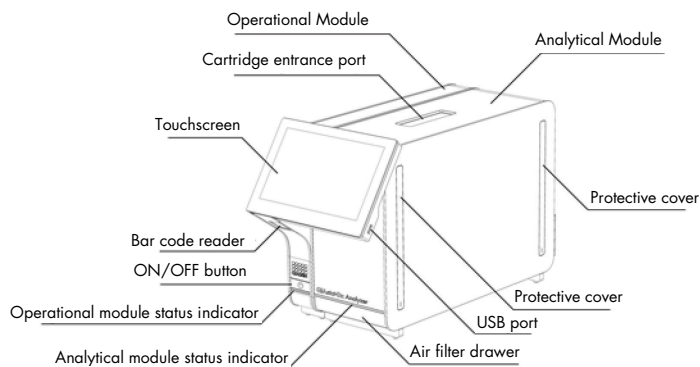

Figure 1. Front view of the QIAstat-Dx Analyzer 1.0. The Operational Module is on the left and the Analytical Module is on the right.

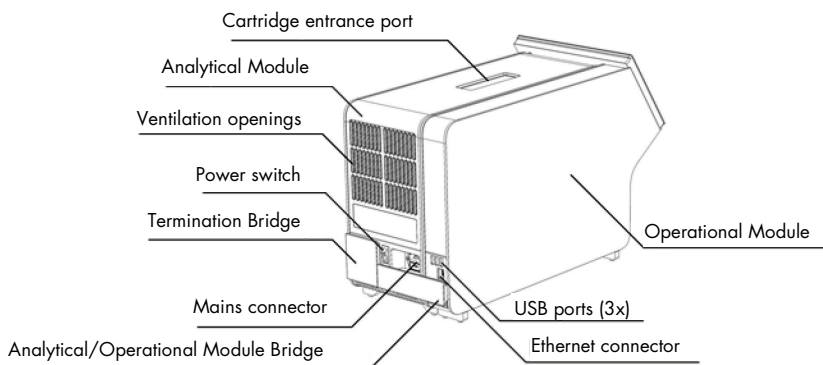

Figure 2. Rear view of the QIAstat-Dx Analyzer 1.0. The Operational Module is on the right and the Analytical Module is on the left.

3.3 QIAstat-Dx assay cartridge description

The QIAstat-Dx assay cartridge is a disposable plastic device that allows performance of fully automated molecular assays. Main features of the QIAstat-Dx assay cartridge include compatibility with various sample types (e.g., fluids, swabs), hermetical containment of all pre-loaded reagents necessary for testing and true walk-away operation. All sample preparation and assay testing steps are performed within the QIAstat-Dx assay cartridge.

All reagents required for the complete execution of a test run are pre-loaded and self-contained in the QIAstat-Dx assay cartridge. The user does not need to come in contact with and/or manipulate any reagents. During the test, reagents are handled in the Analytical Module by pneumatically operated microfluidics and make no direct contact with the QIAstat-Dx Analyzer 1.0 actuators. The QIAstat-Dx Analyzer 1.0 houses air filters for both incoming and outgoing air, further safeguarding the environment. After testing, the QIAstat-Dx assay cartridge stays hermetically closed at all times, greatly enhancing its safe disposal.

Within the QIAstat-Dx assay cartridge, multiple steps are automatically performed in sequence using pneumatic pressure to transfer samples and fluids via the transfer chamber to their intended destinations. After the QIAstat-Dx assay cartridge is introduced into the QIAstat-Dx Analyzer 1.0, the following assay steps occur automatically:

- Resuspension of internal control
- Cell lysis using mechanical and/or chemical means
- Membrane-based nucleic acid purification
- Mixing of the purified nucleic acid with lyophilized master mix reagents
- Transfer of defined aliquots of eluate/master mix to different reaction chambers
- Performance of real-time, multiplex PCR testing within each reaction chamber. An increase in fluorescence, indicating presence of the target analyte, is detected directly within each reaction chamber.

The general layout of the cartridge and its features are illustrated in Figure 3, next page.

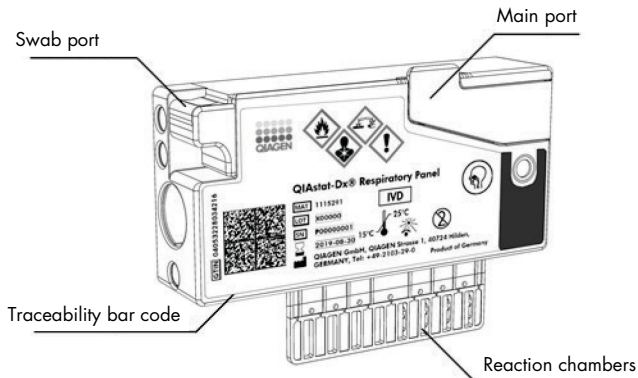

Figure 3. QIAstat-Dx assay cartridge features.

3.4 QIAstat-Dx Analyzer software

The QIAstat-Dx Analyzer's software (SW) is pre-installed on the system. It implements three main groups of functionalities:

- General operation functions allow easy setup, execution, and visualization of a test and its associated results
- Configuration functions allow configuration of the system (user management, assay management, and hardware/software configuration management)
- Test execution control to perform in an automated way the necessary analytical steps that comprise a test execution

4 Installation Procedures

4.1 Site requirements

Select a flat, dry, and clean workbench space for the QIAstat-Dx Analyzer 1.0. Make sure that the space is free of excessive drafts, moisture, and dust, as well as protected from direct sunlight, large temperature fluctuations, heat sources, vibration, and electrical interference. Refer to Section 10 for the weight and dimensions of the QIAstat-Dx Analyzer 1.0 and the correct operating conditions (temperature and humidity). The QIAstat-Dx Analyzer 1.0 should have sufficient clearance on all sides to enable proper ventilation and to allow unimpeded access to the cartridge entrance port, the back of the QIAstat-Dx Analyzer 1.0, the power switch, the ON/OFF button, the bar code reader, and the touchscreen.

Note: Before installing and using the QIAstat-Dx Analyzer 1.0, refer to Section 10 to become familiar with the QIAstat-Dx Analyzer 1.0 operating conditions.

<p>CAUTION</p> 	<p>Impeded ventilation</p> <p>To ensure proper ventilation, maintain a minimum clearance of 10 cm at the rear of the QIAstat-Dx Analyzer 1.0 and do not block airflow under the unit.</p> <p>Slits and openings that ensure instrument ventilation must not be covered.</p>
---	--



<p>CAUTION</p> 	<p>Electromagnetic interference</p> <p>Do not place or use the QIAstat-Dx Analyzer 1.0 in close proximity of sources of strong electromagnetic radiation (e.g., unshielded intentional RF sources), as these can interfere with proper operation.</p>
---	--

4.2 QIAstat-Dx Analyzer 1.0 delivery and components

The QIAstat-Dx Analyzer 1.0 is delivered in two separate boxes and includes all the necessary components for setting up and operating the system. The contents of the boxes are described below:

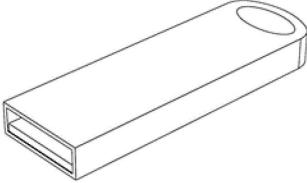
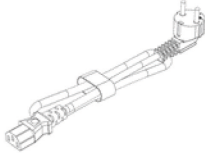
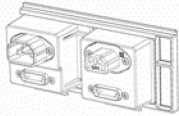
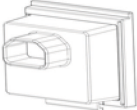
Box 1 contents:

Component	Description
	1x Analytical Module
	1x USB storage device
	1x Power cord
	1x Analytical/Analytical Module Bridge
	1x Termination Bridge

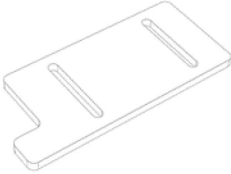
Component	Description
	1x Analytical-Operational Module Assembly Tool
	1x Screen Suede
	1x Protective Cover Removal Tool

Box 2 contents:

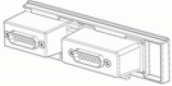
Component	Description
	1x Operational Module
	1x Analytical/Operational Module Bridge

4.3 Unpacking and installing the QIAstat-Dx Analyzer 1.0

Carefully unpack the QIAstat-Dx Analyzer 1.0 according to the following steps:

1. Remove the Analytical Module from its box and place it on a level surface. Remove the foam pieces attached to the Analytical Module.

Note: The Analytical Module must be lifted and handled by taking it from the base with two hands, as shown in Figure 4.

<p>WARNING/ CAUTION</p> 	<p>Risk of personal injury and material damage</p> <p>The QIAstat-Dx Analyzer 1.0 is a heavy instrument. To avoid personal injury or damage to the QIAstat-Dx Analyzer 1.0, take care when lifting it and use appropriate lifting methods.</p>
--	---

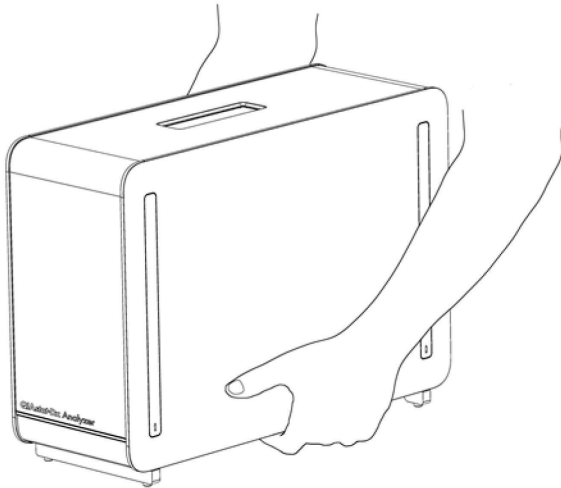

Figure 4. Proper handling of Analytical Module.

2. Remove the protective covers from the side of the Analytical Module using the Protective Cover Removal Tool delivered with the QIAstat-Dx Analyzer 1.0 (Figure 5).

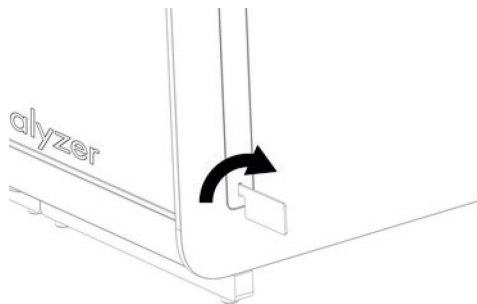



Figure 5. Removing protective covers.

3. Remove the Operational Module from its box and attach it to the left side of the Analytical Module. Tighten the screws using the Analytical-Operational Module Assembly Tool delivered with the QIAstat-Dx Analyzer 1.0 (Figure 6).

<p>CAUTION</p> 	<p>Risk of mechanical damage</p> <p>Do not leave the Operational Module without support or resting on the touchscreen, as this may damage the touchscreen.</p>
---	---

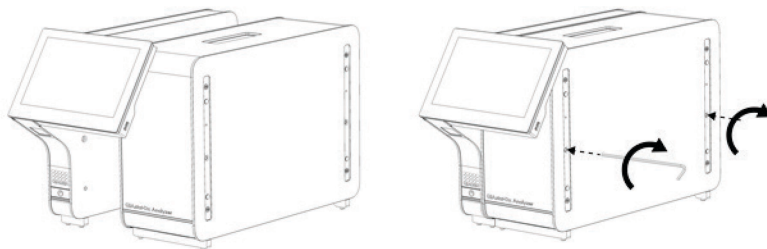

Figure 6. Attaching the Operational Module to the Analytical Module.

4. Reattach the protective covers on the side of the Analytical Module (Figure 7).

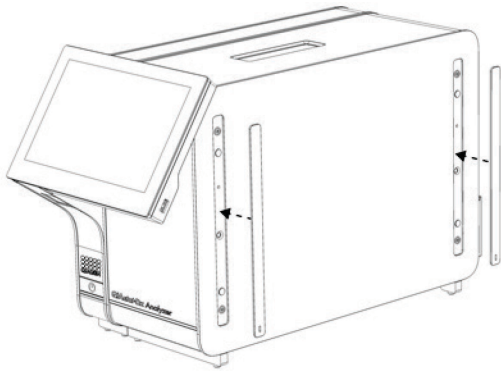

Figure 7. Reattaching the protective covers.

5. Connect the Analytical/Operational Module Bridge at the back of the QIAstat-Dx Analyzer 1.0 to link the Operational and Analytical Modules together (Figure 8).

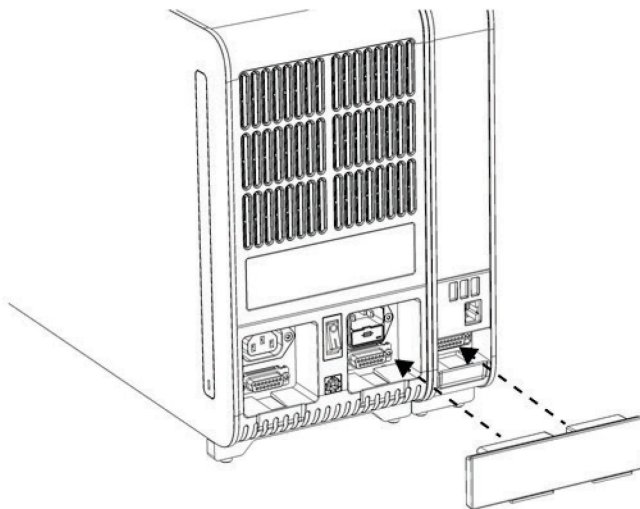

Figure 8. Connecting the Analytical/Operational Module Bridge.

6. Connect the Termination Bridge at the back of the Analytical Module (Figure 9).

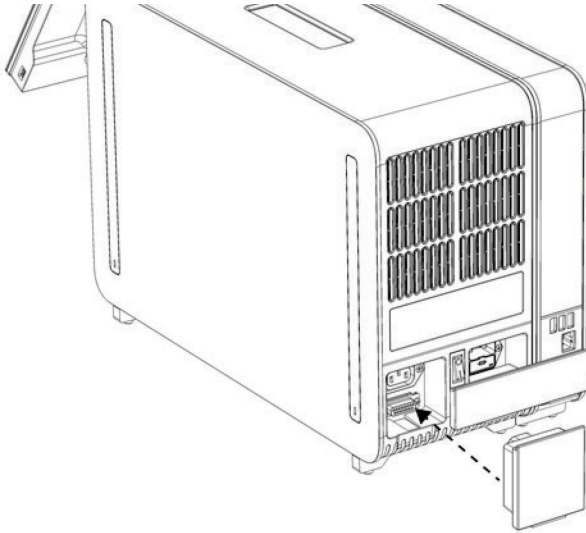

Figure 9. Connecting the Termination Bridge.

7. Connect the power cord that was delivered with the QIAstat-Dx Analyzer 1.0 to the back of the Analytical Module (Figure 10).

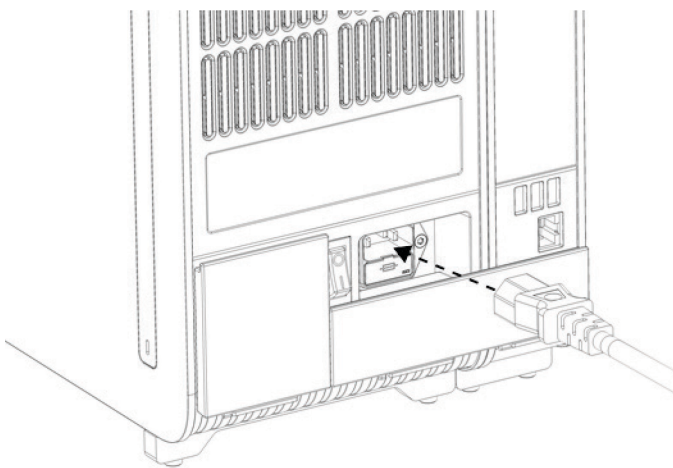

Figure 10. Connecting the power cord.

8. Connect the power cord to a power outlet.

9. Power ON the instrument by pressing the power switch on the back of the Analytical Module to the "I" position (Figure 11). Confirm that the status indicators of the Analytical and Operational Modules are blue.

Note: If a status indicator is red, there is a malfunction in the Analytical Module. Contact QIAGEN Technical Services using the contact information in Section 9 for assistance.

Note: The instrument must not be positioned so that it is difficult to operate the power switch.

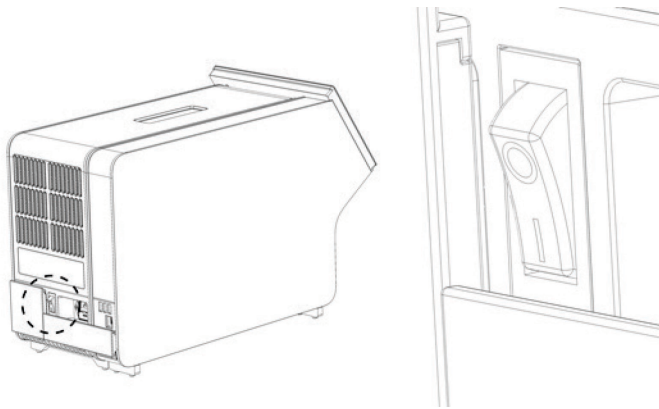

Figure 11. Locating the power switch and setting it to the "I" position.

10. The QIAstat-Dx Analyzer 1.0 is now ready to be configured for its intended use. Refer to Section 6.8 to configure the system parameters, set the system time and date, and configure the network connection.

4.4 Installing additional Analytical Modules

Carefully unpack the additional Analytical Module and install it according to the following steps:

1. Prepare the QIAstat-Dx Analyzer 1.0 for installation of the new module:
 - 1a. Power OFF the system by pressing the ON/OFF button on the front of the QIAstat-Dx Analyzer 1.0.
 - 1b. Power OFF the instrument by pressing the power switch on the back of the Analytical Module to the "O" position.
 - 1c. Remove the power cable.
 - 1d. Remove the Termination Bridge from the back of the Analytical Module (Figure 12, next page).

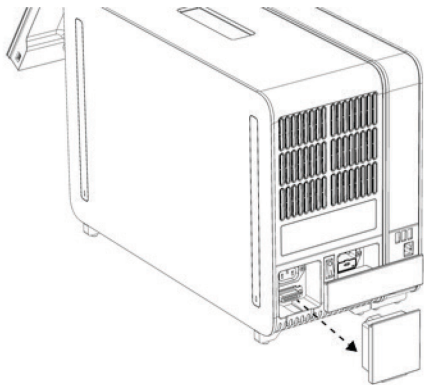

Figure 12. Removing the Termination Bridge.

- 1 e. Remove the protective covers from the side of the Analytical Module, which is where the additional Analytical Module will be attached (Figure 13).

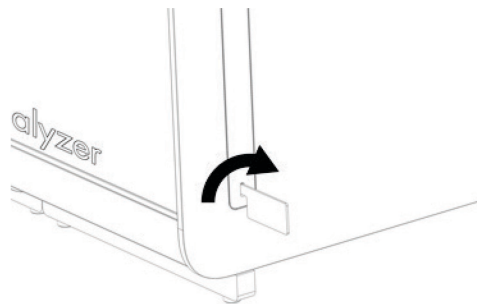

Figure 13. Removing protective covers.

2. Remove the additional Analytical Module from its box and place it on a level surface. Remove the foam pieces attached to the Analytical Module.

Note: The Analytical Module must be lifted and handled by taking it from the base with two hands, as shown in Figure 14, next page.

WARNING/ CAUTION	Risk of personal injury and material damage The QIAstat-Dx Analyzer 1.0 is a heavy instrument. To avoid personal injury or damage to the QIAstat-Dx Analyzer 1.0, take care when lifting it and use appropriate lifting methods.
-----------------------------	--



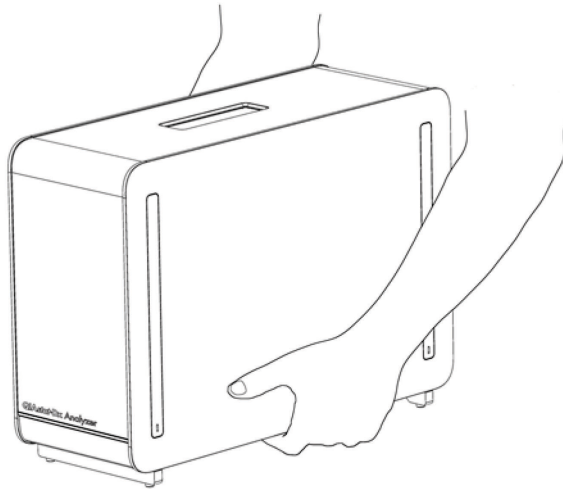

Figure 14. Proper handling of Analytical Module.

3. Remove the protective covers from the side of the Analytical Module using the Protective Cover Removal Tool delivered with the QIAstat-Dx Analyzer 1.0 (Figure 15).

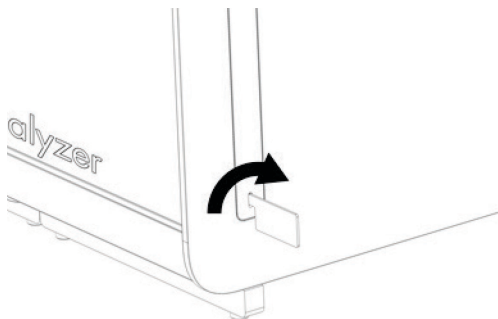

Figure 15. Removing protective covers.

4. Align the additional Analytical Module with the existing Analytical Module. Tighten the screws using the Analytical-Operational Module Assembly Tool delivered with the QIAstat-Dx Analyzer 1.0 (Figure 16).

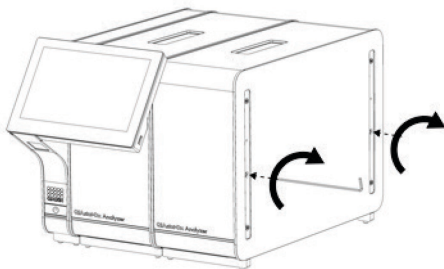

Figure 16. Aligning and attaching the additional Analytical Module.

5. Reattach the protective covers on the side of the additional Analytical Module (Figure 17).

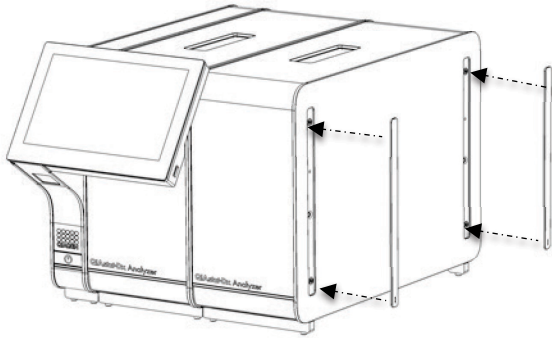

Figure 17. Reattaching protective covers on the additional Analytical Module.

6. Connect the Analytical/Analytical Module Bridge at the back of the QIAstat-Dx Analyzer 1.0 to link the two Analytical Modules together (Figure 18).

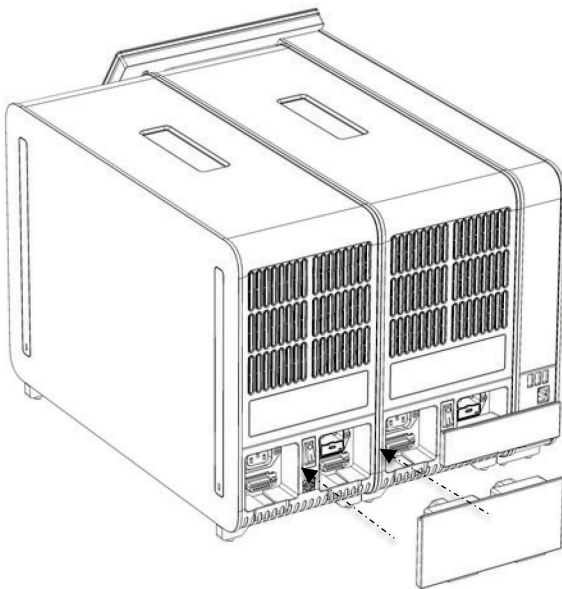

Figure 18. Connecting the Analytical/Analytical Module Bridge.

7. Connect the Termination Bridge at the back of the Analytical Module (Figure 19).

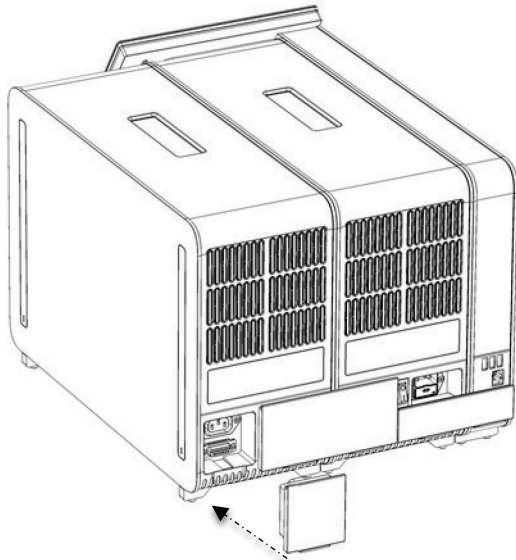

Figure 19. Connecting the Termination Bridge.

8. Connect the power cord that was delivered with the QIAstat-Dx Analyzer 1.0 to the back of the original Analytical Module (Figure 20).

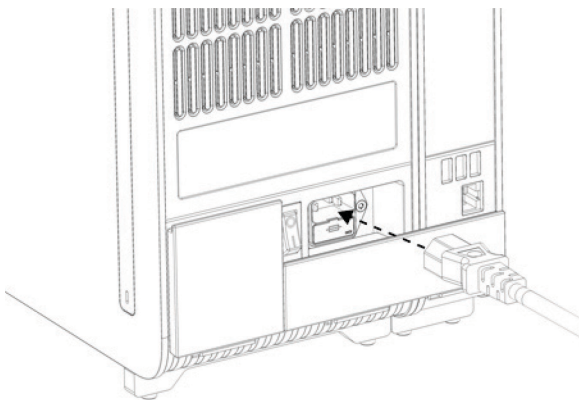

Figure 20. Connecting the power cord.

9. Connect the power cord to a power outlet.

10. Power ON the instrument by pressing the power switch on the back of the Analytical Module to the "I" position (Figure 21). Confirm that the status indicators of the Analytical and Operational Modules are blue.

Note: If a status indicator is red, there is a malfunction in the Analytical Module. Contact QIAGEN Technical Services using the contact information in Section 9 for assistance.

Note: The instrument must not be positioned so that it is difficult to operate the power switch.

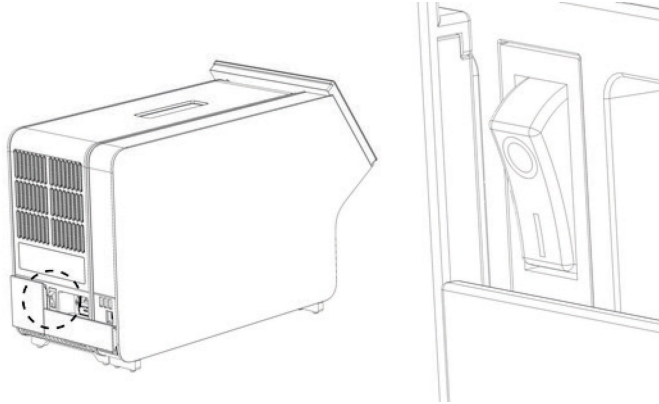

Figure 21. Locating the power switch and setting it to the "I" position.

11. The QIAstat-Dx Analyzer 1.0 is now ready to be configured for its intended use. Refer to Section 6.8 to configure the system parameters, set the system time and date, and configure the network connection.

4.5 Repackaging and shipping the QIAstat-Dx Analyzer 1.0

When repackaging the QIAstat-Dx Analyzer 1.0 for shipping, the original packaging materials must be used. If the original packaging materials are not available, contact QIAGEN Technical Services. Make sure that the instrument has been properly prepared (see Section 8.2) prior to packing and that it poses no biological or chemical hazard.

To repackage the instrument:

1. Make sure the instrument is powered OFF (press power switch to the "O" position).
2. Disconnect the power cord from the power outlet.
3. Disconnect the power cord from the back of the Analytical Module.
4. Disconnect the Termination Bridge at the back of the Analytical Module.
5. Disconnect the Analytical/Operational Module bridge linking the Operational and Analytical Modules at the back of the QIAstat-Dx Analyzer 1.0.

-
6. Remove the protective covers on the side of the Analytical Module using the Protective Cover Removal Tool.
 7. Use the Analytical-Operational Module Assembly Tool to loosen the two screws holding the Operational Module to the Analytical Module. Package the Operational Module in its box.
 8. Reposition the protective covers on the side of the Analytical Module. Package the Analytical Module, with its foam pieces, in its box.

5 Running a Test and Viewing Results

Note: The figures shown in this user manual are only examples and may differ from assay to assay.

5.1 Starting the QIAstat-Dx Analyzer 1.0

1. Press the ON/OFF button on the front of the QIAstat-Dx Analyzer 1.0 to start the unit (Figure 22).

Note: The power switch at the back of the Analytical Module must be set in the “I” position. The Operational and Analytical Module indicators turn blue in the “I” position (i.e., powered ON).

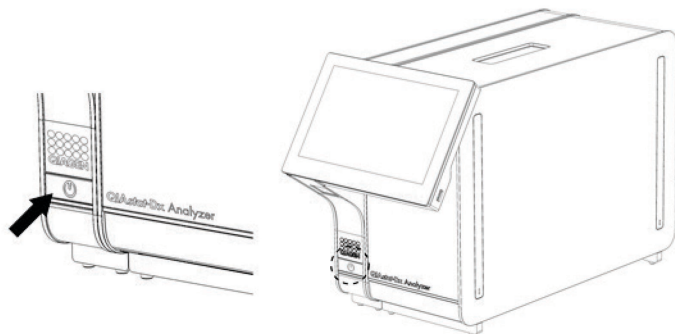

Figure 22. Pressing the ON/OFF button to start the instrument.

2. Wait until the **Main** screen appears and the Analytical and Operational Module status indicators turn green and stop blinking.

Note: After initial installation, the **Login** screen will appear. Refer to Section 6.2 for further details.

Note: After successful initial installation of the QIAstat-Dx Analyzer, the system administrator needs to log in for the first configuration of the software. For the first-time login, the user ID is “administrator” and the default password is “administrator”. The password must be changed after the first login. The User Access Control is activated automatically. It is strongly recommended to create at least one user account, without an “Administrator” role.

5.2 Preparing the QIAstat-Dx assay cartridge

Remove the QIAstat-Dx assay cartridge from its packaging. For details about adding the sample to the QIAstat-Dx assay cartridge and for information specific to the assay to be run, refer to the instructions for use for the specific assay (e.g., QIAstat-Dx Respiratory Panel). Always make sure that both sample lids are firmly closed after adding a sample to the QIAstat-Dx assay cartridge.

5.3 Procedure to run a test

All operators should wear appropriate personal protective equipment, such as gloves, when touching the QIAstat-Dx Analyzer 1.0 touchscreen.

1. Press the **▶ Run Test** button at the top right corner of the **Main** screen.
2. When prompted, scan the sample ID bar code using the bar code reader that is integrated into the Operational Module (Figure 23).

Note: Depending on the QIAstat-Dx Analyzer 1.0 configuration, it may also be possible to enter the sample ID using the virtual keyboard of the touchscreen. Please refer to Section 6.8.4 for further details.

Note: Depending on the chosen system configuration, entering patient ID may also be required at this point. Please refer to Section 6.8.4 for further details.

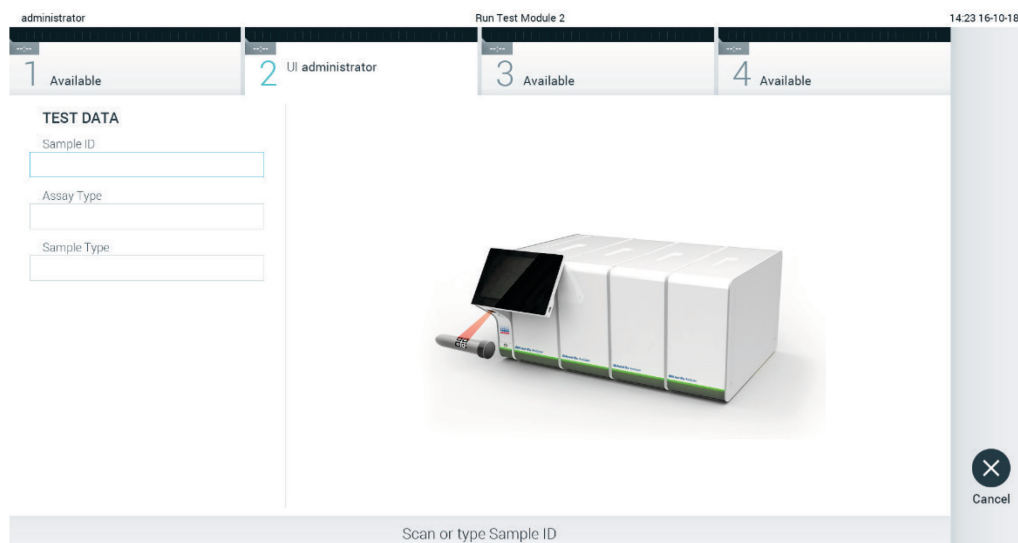

Figure 23. Scanning the sample ID bar code.

3. When prompted, scan the bar code of the QIAstat-Dx assay cartridge to be used. The QIAstat-Dx Analyzer 1.0 automatically recognizes the assay to be run, based on the QIAstat-Dx assay cartridge bar code (Figure 24, next page).

Note: The QIAstat-Dx Analyzer 1.0 will not accept QIAstat-Dx assay cartridges with lapsed expiration dates, previously used cartridges or cartridges for assays that are not installed on the unit. An error message will be shown in these cases. Refer to Section 9.2 for further details.

Note: Refer to Section 6.7.3 for instructions on importing and adding assays to the QIAstat-Dx Analyzer 1.0.

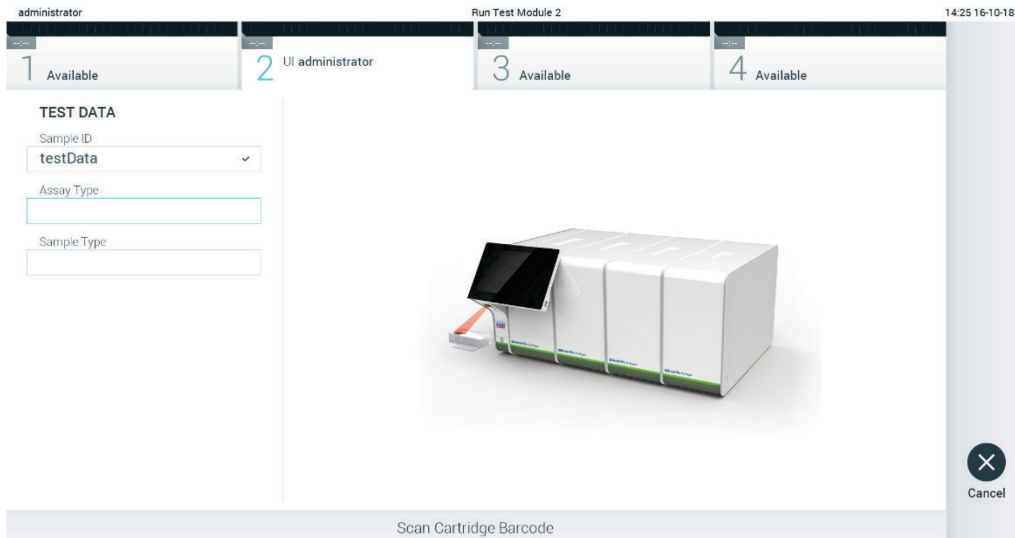

Figure 24. Scanning the QIAstat-Dx assay cartridge bar code.

4. If required, select the appropriate sample type from the list (Figure 25).

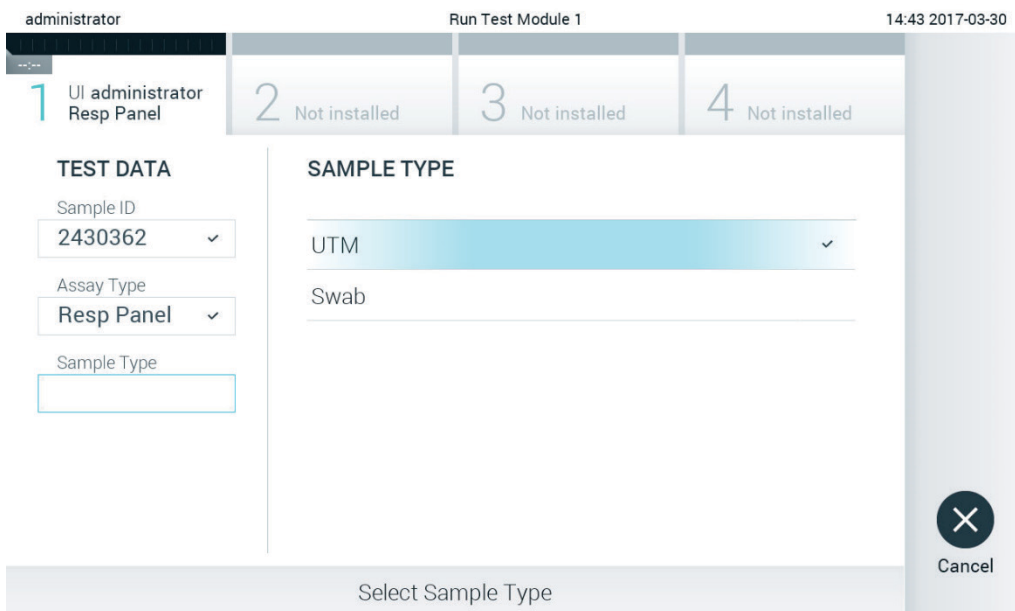

Figure 25. Selecting sample type.

5. The **Confirm** screen will appear. Review the data entered and make any necessary changes by pressing the relevant fields on the touchscreen and editing the information (Figure 26).

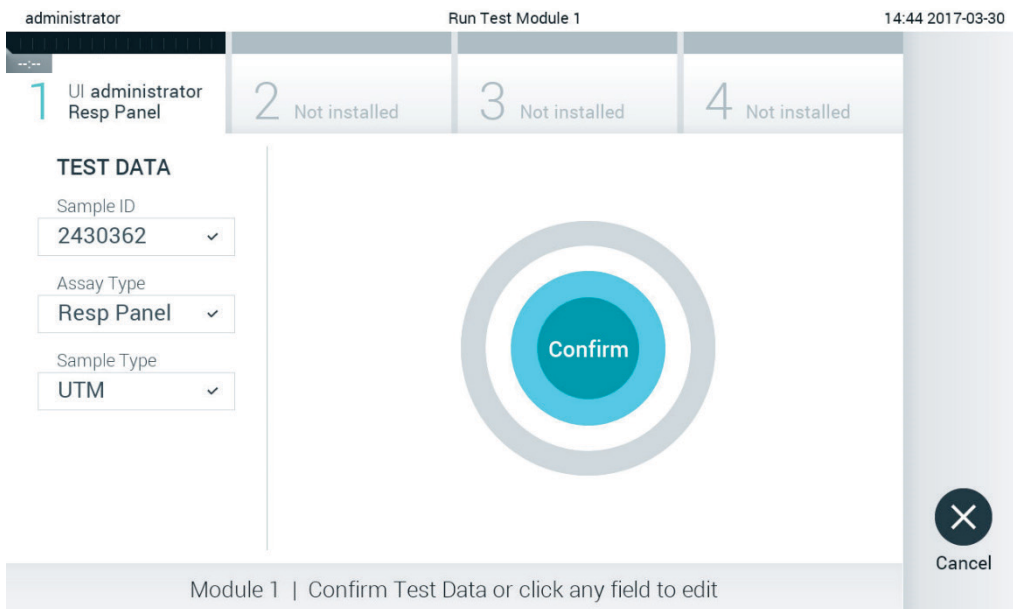

Figure 26. The Confirm screen.

6. Press **Confirm** when all the displayed data are correct. If needed, press on the appropriate field to edit its content, or press **Cancel** to cancel the test.
7. Make sure that both sample lids of the swab port and main port of the QIAstat-Dx assay cartridge are firmly closed. When the cartridge entrance port on the top of the QIAstat-Dx Analyzer 1.0 automatically opens, insert the QIAstat-Dx assay cartridge with the bar code facing to the left and the reaction chambers facing down (Figure 27, next page).
- Note:** When multiple Analytical Modules are connected to an Operational Module, the QIAstat-Dx Analyzer 1.0 automatically selects the Analytical Module in which the test is to be run.
- Note:** There is no need to push the QIAstat-Dx assay cartridge into the QIAstat-Dx Analyzer 1.0. Position it correctly into the cartridge entrance port and the QIAstat-Dx Analyzer 1.0 will automatically move the cartridge into the Analytical Module.

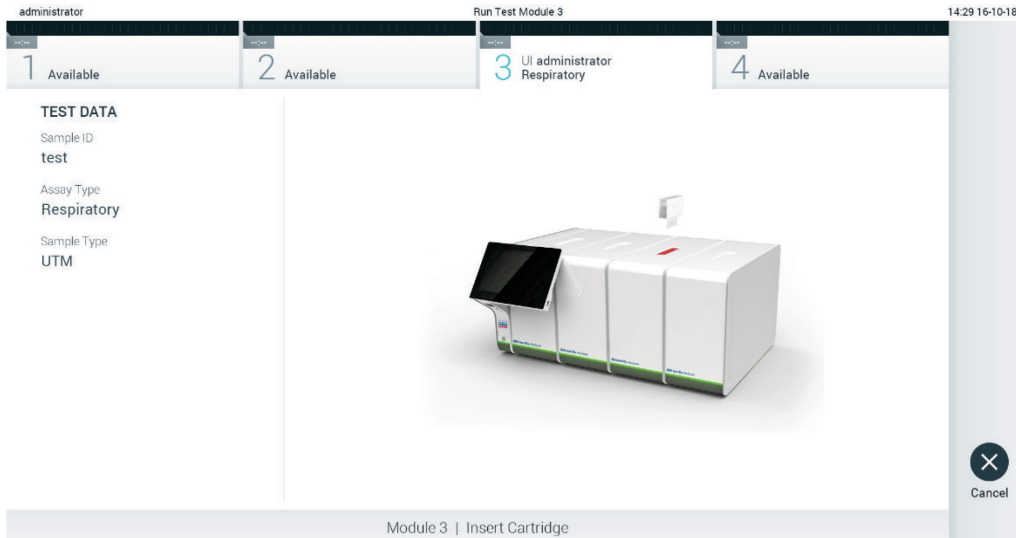

Figure 27. Inserting QIAstat-Dx assay cartridge into QIAstat-Dx Analyzer 1.0.

8. Upon detecting the QIAstat-Dx assay cartridge, the QIAstat-Dx Analyzer 1.0 will automatically close the lid of the cartridge entrance port and start the test run. No further action from the operator is required to start the run.

Note: The QIAstat-Dx Analyzer 1.0 will not accept a QIAstat-Dx assay cartridge other than the one used and scanned during the test setup. If a cartridge other than the one scanned is inserted, an error will be generated, and the cartridge will be automatically ejected.

Note: Up to this point, it is possible to cancel the test run by pressing the **Cancel** button in the bottom right corner of the touchscreen.

Note: Depending on the system configuration, the operator may be required to re-enter their user password to start the test run.

Note: The lid of the cartridge entrance port will close automatically after 30 seconds if a QIAstat-Dx assay cartridge is not positioned in the port. If this occurs, repeat the procedure starting with step 5.

9. While the test is running, the remaining run time is displayed on the touchscreen (Figure 28, next page).

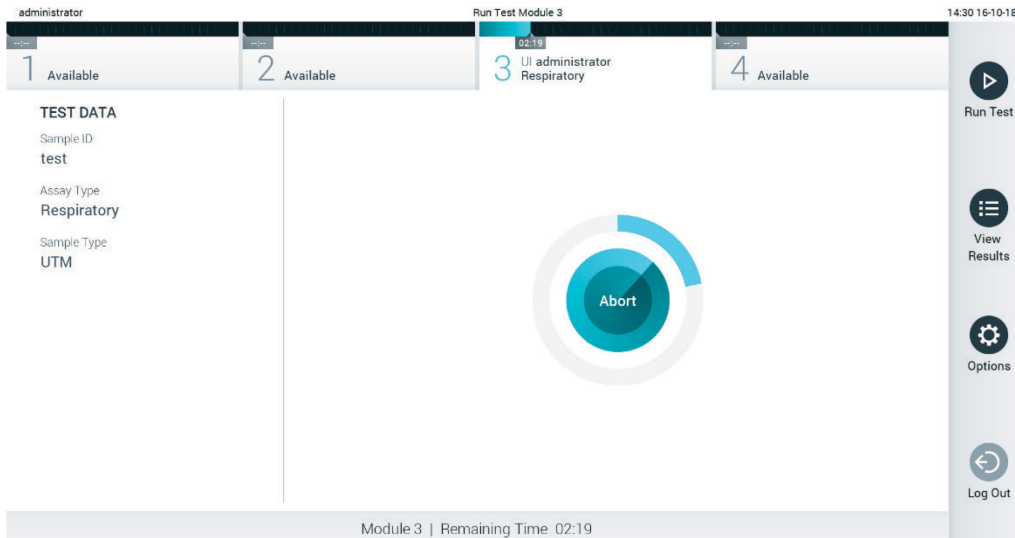



Figure 28. Test execution and remaining run time display.

10. After the test run is completed, the **Eject** screen will appear (Figure 29, next page). Press  **Eject** on the touchscreen to remove the QIAstat-Dx assay cartridge and dispose of it as biohazardous waste in accordance with all national, state, and local health and safety regulations and laws.

Note: The QIAstat-Dx assay cartridge should be removed when the cartridge entrance port opens and ejects the cartridge. If the cartridge is not removed after 30 seconds, it will automatically move back into the QIAstat-Dx Analyzer 1.0 and cartridge entrance port lid will close. If this occurs, press **Eject** to open the lid of the cartridge entrance port again and then remove the cartridge.

Note: Used QIAstat-Dx assay cartridges must be discarded. It is not possible to reuse cartridges for tests for which the execution was started but then subsequently canceled by the operator, or for which an error was detected.

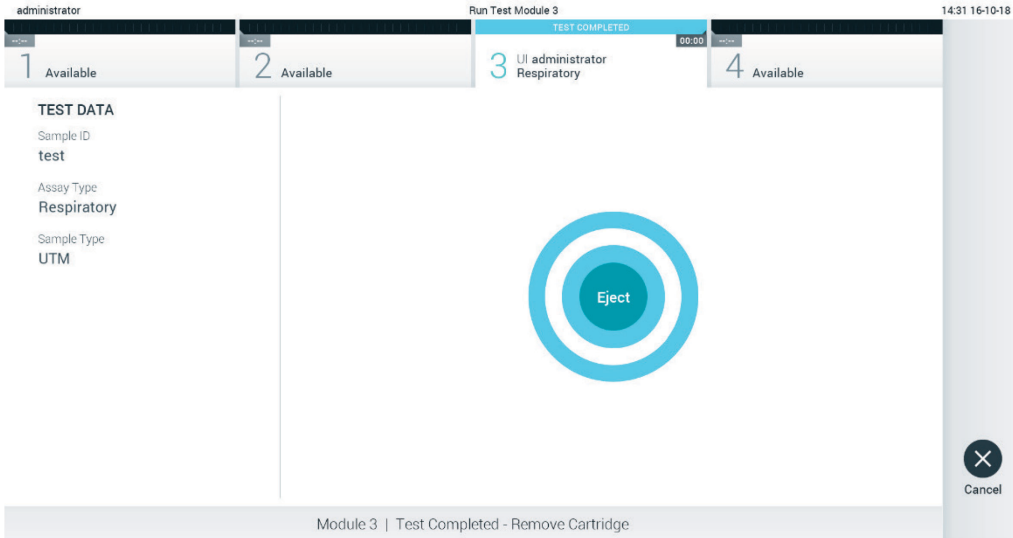

Figure 29. Eject screen display.

11. After the QIAstat-Dx assay cartridge has been ejected, the results **Summary** screen will appear (Figure 30). Refer to Section 5.4 for further details.

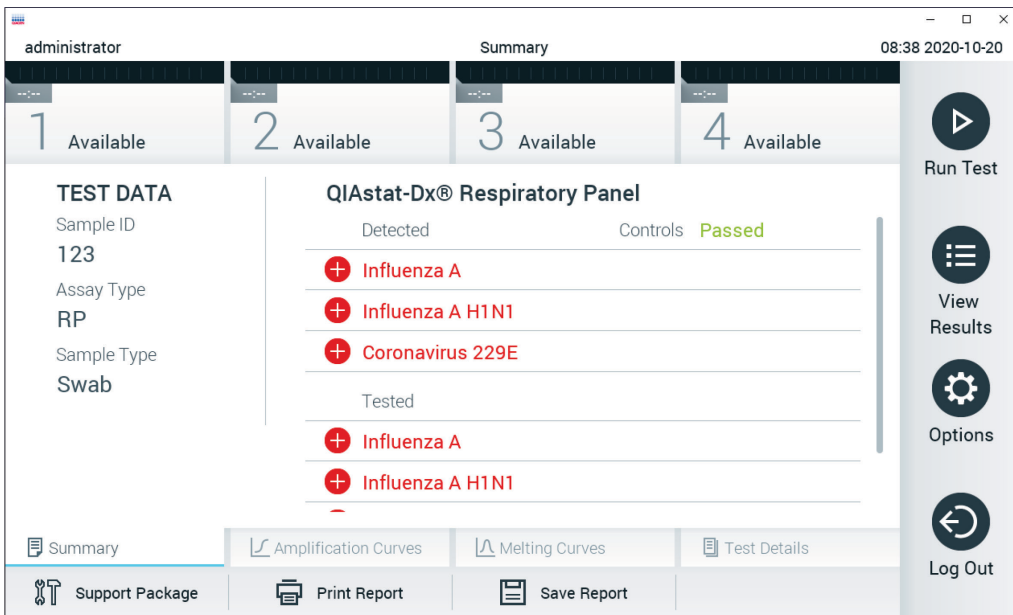

Figure 30. Results Summary screen.

5.3.1 Canceling a test run

If a test run is already in progress, pressing **Abort** will stop the execution of the test (Figure 31).

Note: Used QIAstat-Dx assay cartridges must be discarded. It is not possible to reuse cartridges for tests for which the execution was started but then subsequently canceled by the operator, or for which an error was detected.

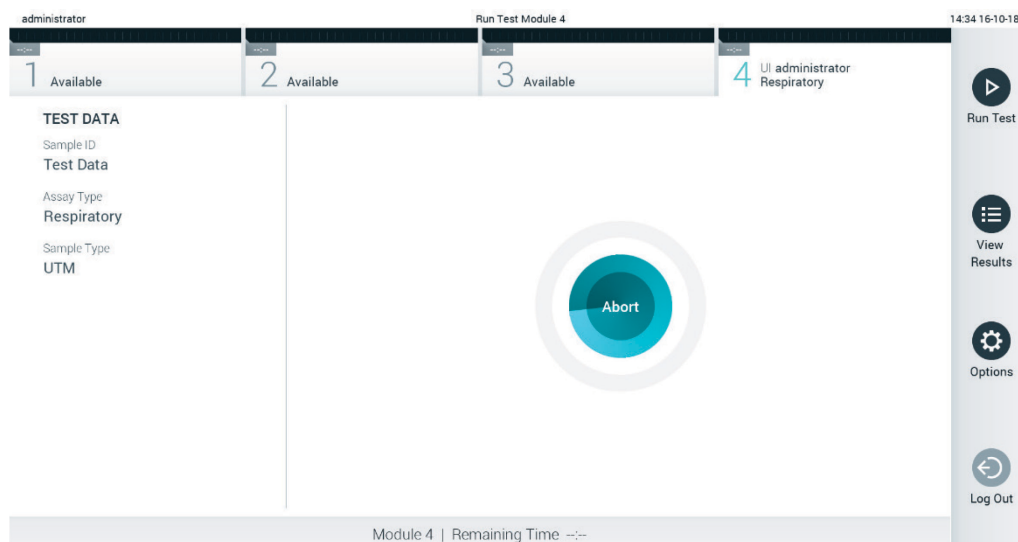

Figure 31. Canceling a test run.

After aborting a test, the QIAstat-Dx assay cartridge can no longer be processed and cannot be re-used. After pressing **Abort**, a dialog will appear prompting the operator to confirm that the test should be canceled (Figure 32).

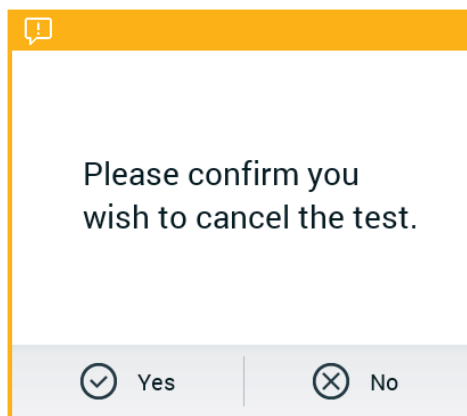

Figure 32. Canceling a test run confirmation dialog.

5.4 Viewing results

The QIAstat-Dx Analyzer 1.0 automatically interprets and saves test results. After ejecting the QIAstat-Dx assay cartridge, the results **Summary** screen is automatically displayed (Figure 33).

Note: Refer to assay-specific instructions for use for possible results and instructions on how to interpret assay results.

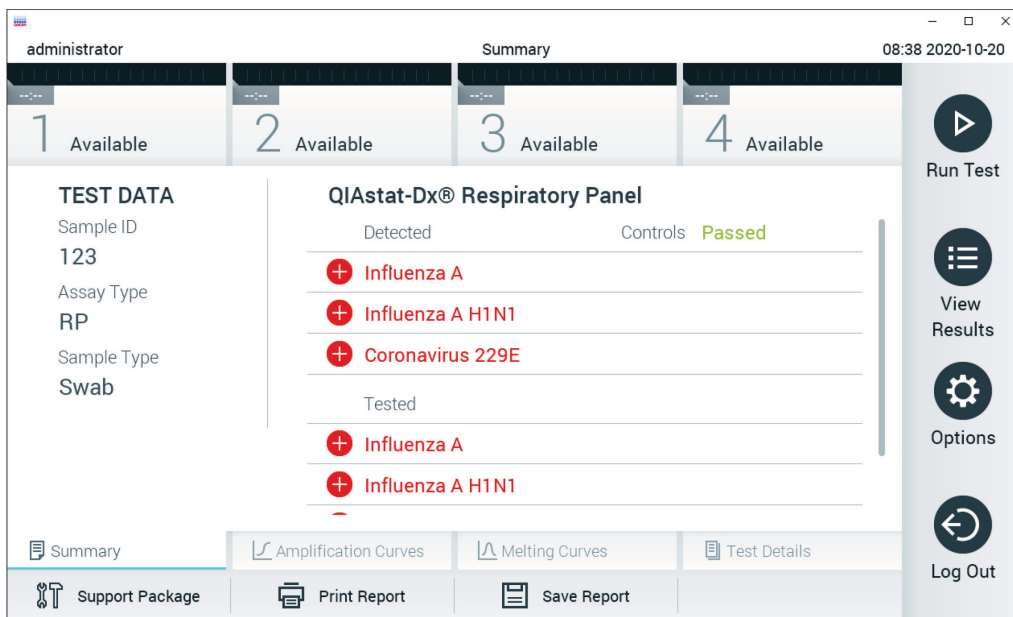

Figure 33. Results Summary screen example showing Test Data in the left panel and test Summary in the main panel.

The main part of the screen provides the following three lists and uses color-coding and symbols to indicate the results:

- The first list includes all pathogens detected and identified in the sample, preceded by a **+** sign and are colored red.
- The second list includes all equivocal pathogens, preceded by a question mark **?** and are colored yellow.
- The third list includes all pathogens tested in the sample. Pathogens detected and identified in the sample are preceded by a **+** sign and are colored red. Pathogens that were tested but not detected are preceded by a **-** sign and are colored green. Equivocal pathogens are preceded by a question mark **?** and are colored yellow.

Note: Pathogens detected and identified in the sample are shown in all lists.

If the test failed to complete successfully, a message will indicate “Failed” followed by the specific Error Code.

The following Test Data are shown on the left side of the screen:

- Sample ID
- Patient ID (if available)
- Assay Type
- Sample Type

Further data about the assay is available, depending on the operator’s access rights, through the tabs at the bottom of the screen (e.g., amplification plots, melting curves and test details).

Assay data can be exported by pressing **Save Report** in the bottom bar of the screen.

A report can be sent to the printer by pressing **Print Report** in the bottom bar of the screen.

A support package of the selected run or all failed runs can be created by pressing **Support Package** at the bottom bar of the screen (Figure 34, next page). If support is required, send the support package to the QIAGEN Technical Services.

5.4.1 Viewing amplification curves

To view the test amplification curves, press the  **Amplification Curves** tab (Figure 34, next page). This function may not be available for all assays.

Note: Please be advised that the amplification curves are not meant to interpret test results.

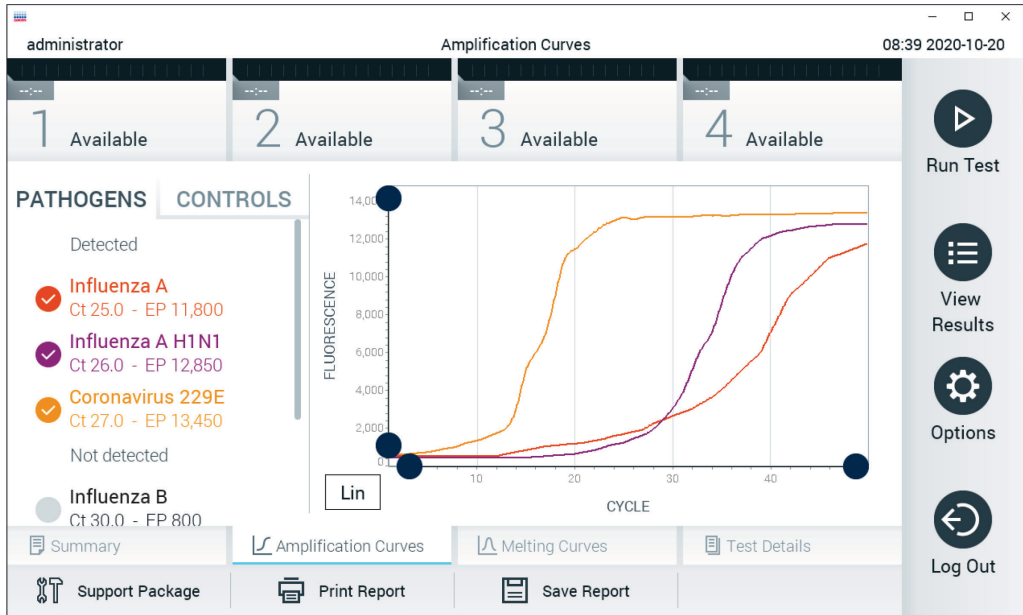

Figure 34. Amplification Curves screen (PATHOGENS tab).

Details about the tested pathogens and controls are shown on the left and the amplification curves are shown in the center.

Note: If **User Access Control** is enabled (refer to Section 6.6) on the QIAstat-Dx Analyzer 1.0, the **Amplification Curves** screen is only available for operators with access rights.

Press the **PATHOGENS** tab on the left side to display the plots corresponding to the tested pathogens. Press on the pathogen name to select which pathogens are shown in the amplification plot. It is possible to select single, multiple or no pathogens. Each pathogen in the selected list will be assigned a color corresponding to the amplification curve associated with the pathogen. Unselected pathogens will be shown in gray.

The corresponding C_T and endpoint fluorescence values are shown below each pathogen name.

Press the **CONTROLS** tab on the left side to view the controls and select which controls are shown in the amplification plot. Press the circle next to the control name to select or deselect it (Figure 35, next page).

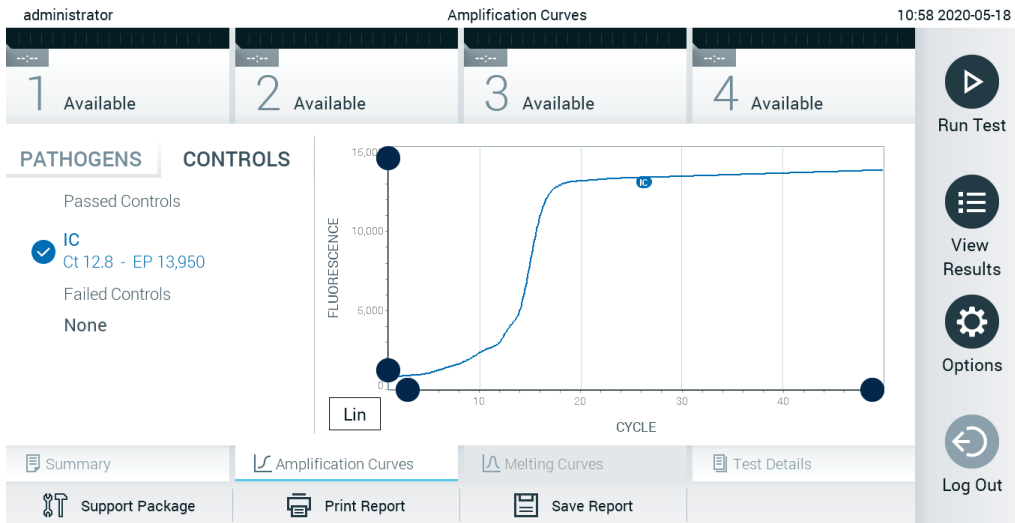

Figure 35. Amplification Curves screen (CONTROLS tab).

The amplification plot displays the data curve for the selected pathogens or controls. To alternate between logarithmic or linear scale for the Y-axis, press the **Lin** or **Log** button at the bottom left corner of the plot.

The scale of the X-axis and Y-axis can be adjusted using the blue pickers on each axis. Press and hold a blue picker and then move it to the desired location on the axis. Move a blue picker to the axis origin to return to the default values.

5.4.2 Viewing melting curves

To view the test melting curves, press the **Melting Curves** tab.

Details about the tested pathogens and controls are shown on the left and the melting curves are shown in the center.

Note: The **Melting Curves** tab is only available for assays implementing melting analysis.

Note: If **User Access Control** is enabled (refer to Section 6.6) on the QIAstat-Dx Analyzer 1.0, the **Melting Curves** screen is only available for operators with access rights.

Press the **PATHOGENS** tab on the left side to display the tested pathogens. Press the circle next to the pathogen name to select which pathogen melting curves are shown. It is possible to select single, multiple or no pathogens. Each pathogen in the selected list will be assigned a color corresponding to the melting curve associated with the pathogen. Unselected pathogens will be shown in gray. The melting temperature is shown below each pathogen name.

Press the **CONTROLS** tab on the left side to view the controls and select which controls are shown in the melting plot. Press the circle next to the control name to select or deselect it.

Controls that passed the analysis are shown in green and are labeled “Passed Controls”, while those that failed are shown in red and are labeled “Failed Controls”.

The scale of the X-axis and Y-axis can be adjusted using the  blue pickers on each axis. Press and hold a blue picker and then move it to the desired location on the axis. Move a blue picker to the axis origin to return to the default values.

5.4.3 Viewing test details

Press  **Test Details** to review the results in more detail. Scroll down to see the complete report.

The following Test Details are shown in the center of the screen (Figure 36, next page):

- User ID
- Cartridge SN (serial number)
- Cartridge Expiration Date
- Module SN (serial number)
- Test Status (Completed, Failed or Canceled by operator)
- Error Code (if applicable)
- Error Message (if applicable)
- Test Start Date and Time
- Test Execution Time
- Assay Name
- Test ID
- Test Result (for every analyte, total result of the test: Positive [pos], Positive with Warning [pos*], Negative [neg], Invalid [inv], Failed [fail] or successful [suc]. Refer to assay-specific instructions for use for details on possible results and their interpretation)
- List of analytes tested in the assay (grouped by Detected Pathogen, Equivocal, Not Detected Pathogens, Invalid, Not Applicable, Out of Range, Passed Controls and Failed Controls), with C_T and endpoint fluorescence (if available for the assay)
- List of controls, with C_T and endpoint fluorescence (if available for the assay)

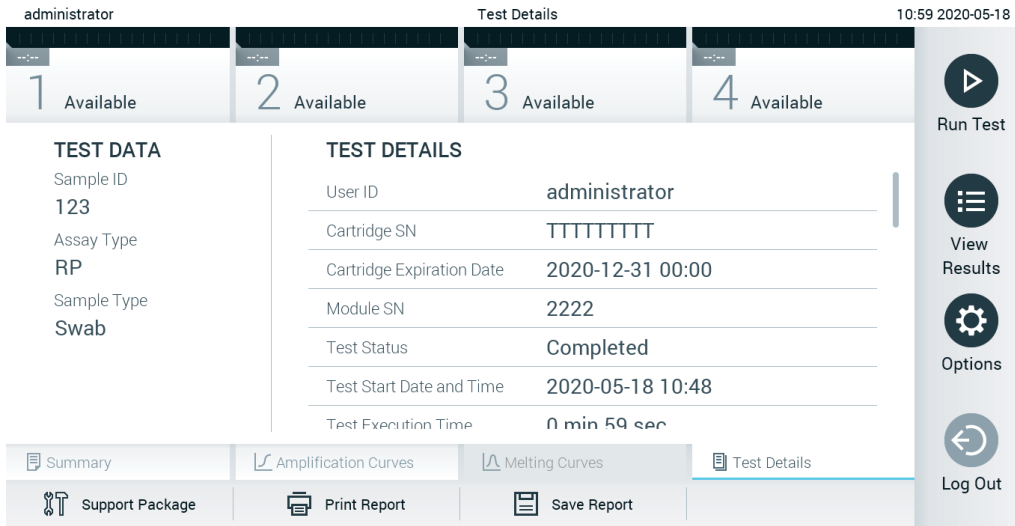

Figure 36. Example screen showing Test Data in the left panel and Test Details in the main panel.

5.4.4 Browsing results from previous tests

To view results from previous tests that are stored in the results repository, press **View Results** on the Main Menu bar (Figure 37).

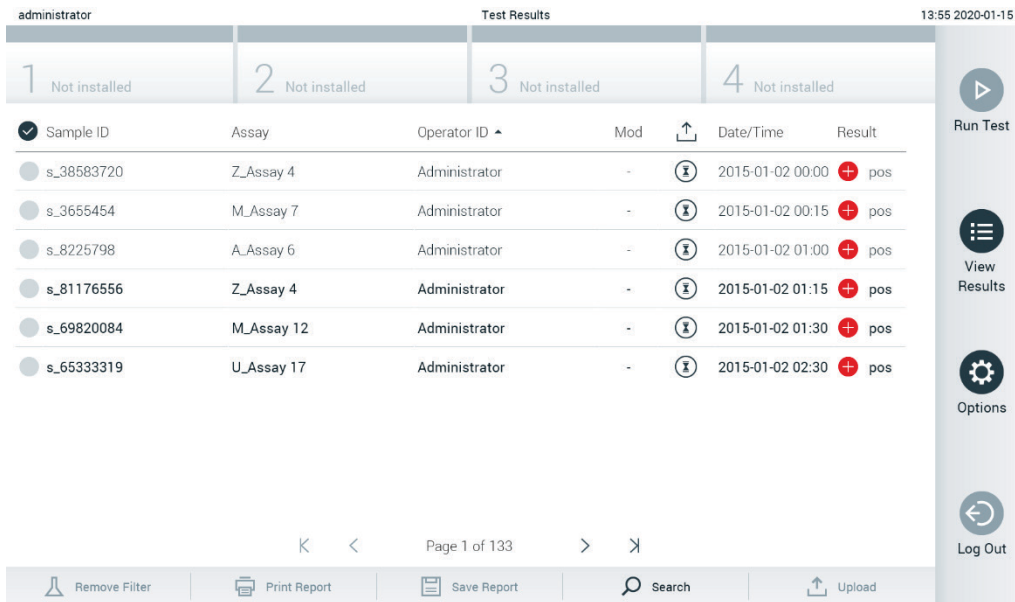



Figure 37. Example View Results screen.

The following information is available for every executed test (Figure 38):

- Sample ID
- Assay (name of test assay)
- Operator ID
- Mod (Analytical Module on which the test was executed)
- Upload status (only visible if activated via HIS/LIS settings)
- Date/Time (date and time when the test was finished)
- Result (outcome of the test: positive [pos], pos with warning [pos*], negative [neg], invalid [inv], failed [fail] or successful [suc])

Note: Possible outcomes are assay-specific (i.e., some outcomes may not be applicable for each assay). Refer to the assay-specific instructions for use.

Note: If **User Access Control** is enabled (refer to Section 6.6) on the QIAstat-Dx Analyzer 1.0, the data for which the user has no access rights will be hidden with asterisks.

Select one or more test results by pressing the **gray circle** to left of the sample ID. A **checkmark** will appear next to selected results. To deselect test results, pressing the **checkmark**. The entire list of results can be selected by pressing the  checkmark circle in the top row (Figure 38).

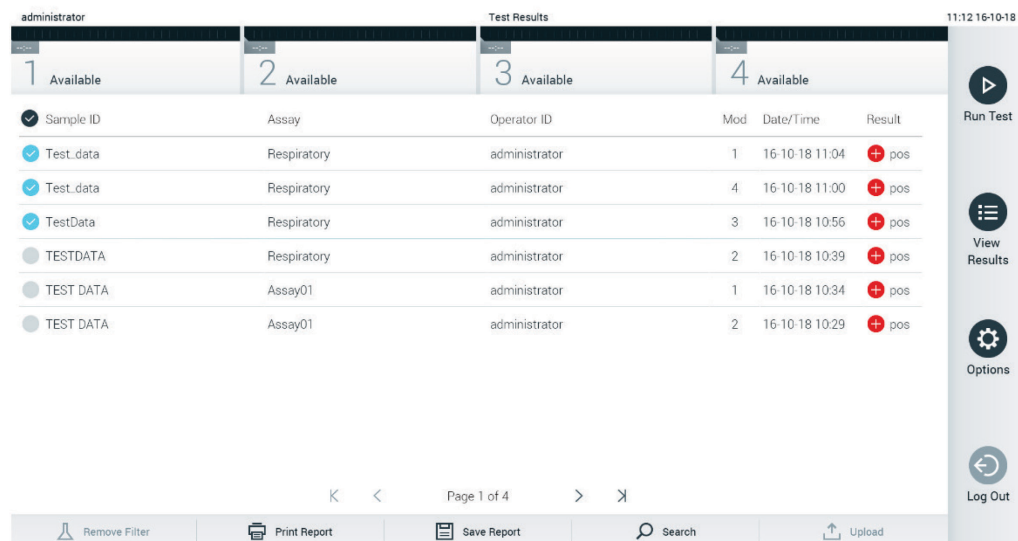

Sample ID	Assay	Operator ID	Mod	Date/Time	Result
1 Available	Respiratory	administrator	1	16-10-18 11:04	pos
2 Available	Respiratory	administrator	4	16-10-18 11:00	pos
3 Available	Respiratory	administrator	3	16-10-18 10:56	pos
4 Available	Respiratory	administrator	2	16-10-18 10:39	pos
	Assay01	administrator	1	16-10-18 10:34	pos
	Assay01	administrator	2	16-10-18 10:29	pos

Figure 38. Example of selecting Test Results in the View Results screen.







Press anywhere in the test row to view the result for a particular test.

Press a column headline (e.g., **Sample ID**) to sort the list in ascending or descending order according to that parameter. The list can be sorted according to only one column at a time.

The **Result** column shows the outcome of each test (Table 1).

Note: Possible outcomes are assay-specific (i.e., some outcomes may not be applicable for each assay). Refer to the assay-specific instructions for use.

Table 1. Description of test results

Outcome	Result	Description
Positive	 pos	At least one analyte is positive
Positive with warning	 pos*	At least one analyte is positive, but an assay control failed
Negative	 neg	No analytes were detected
Failed	 fail	The test failed because either an error occurred, or the test was canceled by the user
Invalid	 inv	The test is invalid
Successful	 suc	The test is either positive or negative, but the user does not have the access rights to view the test results

Note: Refer to the assay IFU for the test being performed for a detailed description of results.

Make sure a printer is connected to the QIAstat-Dx Analyzer 1.0 and the proper driver is installed (Appendix 11.1). Press **Print Report** to print the report(s) for the selected result(s).

Press **Save Report** to save the report(s) for the selected result(s) in PDF format to an external USB storage device.

Note: It is recommended to use the delivered USB storage device for short-term data storage and transfer. The use of a USB storage device is subject to restrictions (e.g. the memory capacity or the risk of overwriting, which should be considered before usage).

Select the report type: List of Tests or Test Reports. Press **Search** to search the test results by Sample ID, Assay, and Operator ID. Enter the search string using the virtual keyboard and press **Enter** to start the search. Only the records containing the search text will be displayed in the search results. If the results list has been filtered, the search will only apply to the filtered list. Press and hold a column headline to apply a filter based on that parameter. For some parameters, such as Sample ID, the virtual keyboard will appear so the search string for the filter can be entered.

For other parameters, such as Assay, a dialog will open with a list of assays stored in the repository. Select one or more assays to filter only the tests that were performed with the selected assays.

The **T** symbol to the left of a column headline indicates that the column's filter is active. A filter can be removed by pressing **Remove Filter** in the Submenu bar.

5.4.5 Exporting results to a USB drive

From any tab of the **View Results** screen, select **Save Report** to export and save a copy of the test results in PDF format to a USB drive. The USB port is located on the front of the QIAstat-Dx Analyzer 1.0 (Figure 39).

Note: It is recommended to use the delivered USB storage device for short-term data saving and transfer. The use of a USB stick is subject to restrictions (e.g. the memory capacity or the risk of overwriting, which should be considered before usage).

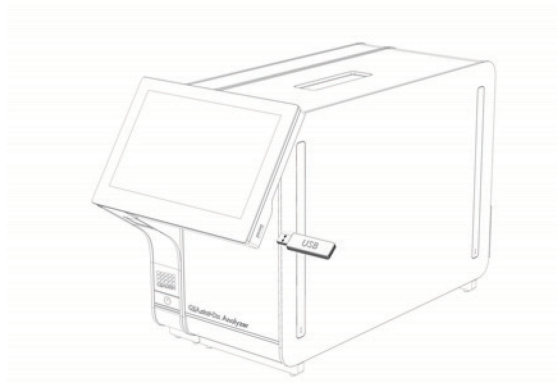

Figure 39. Location of USB port.

5.4.6 Printing results

Make sure a printer is connected to the QIAstat-Dx Analyzer 1.0 and the proper driver is installed (see Appendix 11.1 for more information on driver installation). Press **Print Report** to send a copy of the test results to the printer.

5.4.7 Creating a support package

If support is required, a support package containing all required run information, system, and technical log files can be created and provided to QIAGEN Technical Service. For creating a support package, click on the tab Support Package. A dialog appears and a support package for the selected test or all failed tests can be created (Figure 40). Save the support package to a USB storage device. The USB port is located on the front of the QIAstat-Dx Analyzer 1.0 (Figure 39).

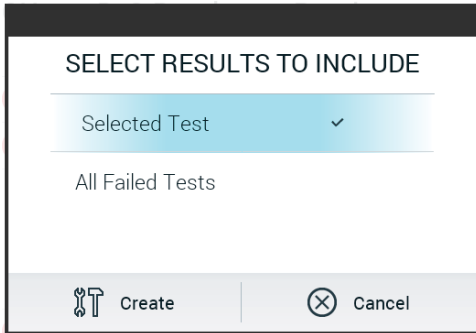

Figure 40. Support Package creation.

Note: It is recommended to use the delivered USB storage device for short-term data storage and transfer. The use of a USB storage device is subject to restrictions (e.g., the memory capacity or the risk of overwriting), which should be considered before usage.

Note: If support is required, ensure that a support package is created shortly after the problem occurred. Due to limited storage capacity and configuration of the system, system and technical log files of the respective time interval may be deleted automatically when continuing usage of the system.

6 System Functions and Options

This section provides a description of all the available QIAstat-Dx Analyzer 1.0 features and options that enable customization of the instrument settings.

6.1 Main screen

In the **Main** screen, it is possible to view the status of the Analytical Modules and navigate to different sections (**Login**, **Run Test**, **View Results**, **Options**, and **Log Out**) of the user interface (Figure 41).

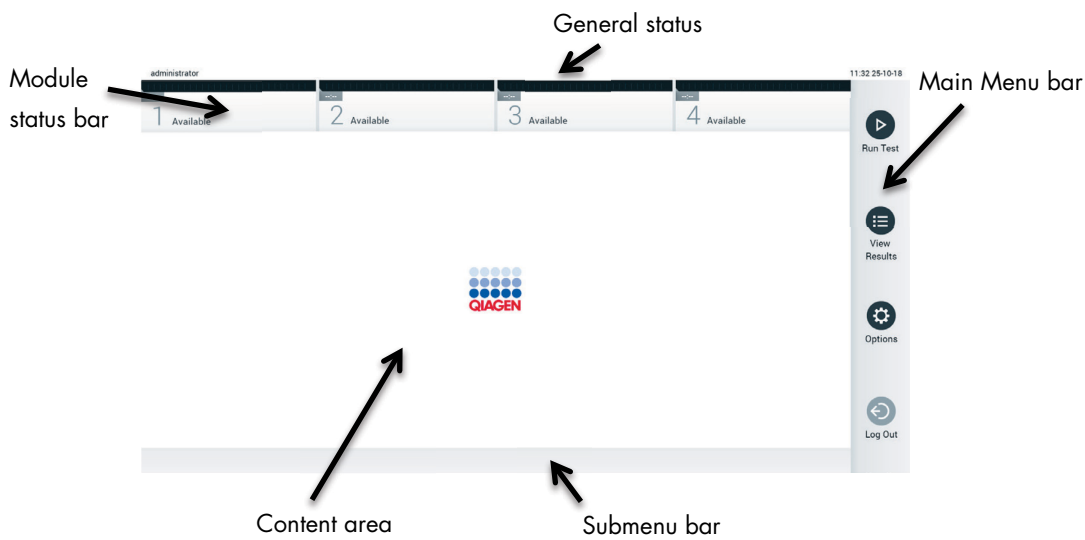

Figure 41. Main screen of the QIAstat-Dx Analyzer 1.0 touchscreen.

The **Main** screen includes the following elements:

- General status bar
- Module status bar
- Main Menu bar
- Content area
- Tab Menu bar (optionally shown, depends on screen)
- Submenu bar and Instructions bar (optionally shown, depends on screen)

6.1.1 General status bar

The General status bar provides information about the status of the system (Figure 42). The User ID of the logged-in user appears on the left side. The title of the screen appears in the middle, and the system date and time appear on the right.



Figure 42. General status bar.

6.1.2 Module status bar

The Module status bar displays the status of each Analytical Module (1–4) available in the system in corresponding status boxes (Figure 43). The boxes display “Not Installed” if no Analytical Module is available for that position.

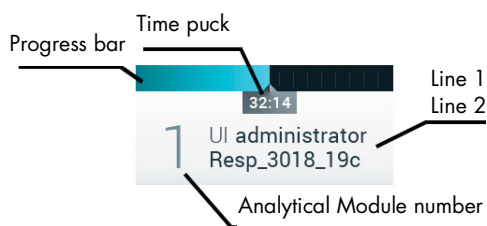



Figure 43. Module status bar.

Click on the box corresponding to a particular Analytical Module to access more detailed information (see Module status page). Module states that may be displayed in a status box of the Module status bar are shown in Table 2 (next page).

Table 2. Module states that may be displayed in status boxes

State	Description
Not installed	No Analytical Module is installed at that position.
Excluded	The Analytical Module has been excluded by the user via user settings.
Error	The Analytical Module reported a serious error. The Analytical Module is out of order.
Initializing	The Analytical Module is starting up and is performing the self-test.
Available	The Analytical Module is available for a new test. There is no test running in this Analytical Module, no QIAstat-Dx assay cartridge is inserted and the lid of the cartridge entrance port is closed.
	User "administrator" is currently running the Resp_3018_19c test on Analytical Module 1. There are 32 minutes and 14 seconds remaining to complete the test.
	User "administrator" has run the Resp Panel test on Analytical Module 1. The progress bar in the box will show the test status: TEST COMPLETED: the test was completed successfully. TEST FAILED: the test was completed, but an error occurred. TEST CANCELED: the user canceled the test. Once the QIAstat-Dx assay cartridge has been removed and the lid of the cartridge entrance port has closed, the Analytical Module will be available again.
Eject cartridge	The Analytical Module contains a QIAstat-Dx assay cartridge and the lid of the cartridge entrance port is closed, but no test is currently running. This can occur in the following situations: <ul style="list-style-type: none"> • The cartridge was not removed after an ejection due to a canceled or completed test. • The system was powered off with a cartridge inside the Analytical Module.

6.1.3 Module status page

The Module status page displays information such as position, serial number, HW revision, and current software version. Additionally, errors concerning the selected Analytical Module are shown as well as information about software and hardware components (Figure 44, next page).

The instruction bar shows a reboot button that can be used to restart the selected Module without having to restart the entire device. The button is only enabled when the selected Module is in an error or "out of order" state.







Figure 44. The Module status page.

The Module status page can be accessed at any time, except when the AM is in the “Not installed”, “Not present”, or “Initializing” state. During a run and when the cartridge is still inserted, the Module status page will not be shown, instead, it will show the module status bar (introduced in the previous subsection).

6.1.4 Main Menu bar

Table 3 shows the options that are available to the user through the Main Menu bar.

Table 3. Main Menu bar options

Name	Button	Description
Run Test		Starts the run test sequence (see Section 5.3). The QIAstat-Dx Software automatically selects an available Analytical Module and starts the test preparation sequence.
View Results		Opens the View Results screen (see Section 5.4).
Options		Displays the Options submenu (see Section 6.4).
Log Out		Logs the user out (only active when User Access Control is enabled).

6.1.5 Content area

The information displayed in the main content area varies according to the state of the user interface. Results, summaries, configurations, and settings are displayed in this area upon entering different modes and selecting items from the menus described below.

Depending on the content, further options may be available through the Tab Menu bar and **Options** menu. The **Options** submenu is accessed by pressing the **Options** button (Figure 45).

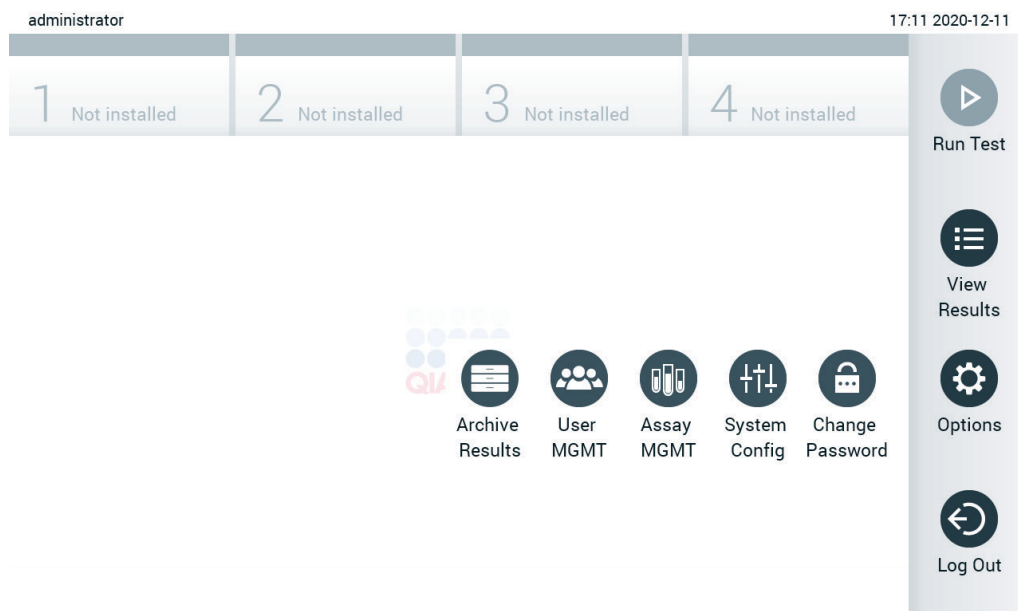

Figure 45. Accessing the Options submenu.

6.2 Login screen

When **User Access Control** is enabled (refer to Section 6.6), users must identify themselves by logging in to access the QIAstat-Dx Analyzer 1.0 functions.

IMPORTANT: For the first-time login, the user ID is “administrator” and the default password is “administrator”. The password must be changed after the first login.

Note: After successful initial installation of the QIAstat-Dx Analyzer, the User Access Control is activated automatically.

Note: It is strongly recommended to create at least one user account without an “Administrator” role at first login.

The content area of the login screen includes a text box for entering the **User ID** (Figure 46). If the option **Show previous user logins** is selected, a list of the previous five users that logged in successfully will also be displayed.

Note: The service technician login icon in the lower right corner of the screen should only be used by personnel authorized by QIAGEN.

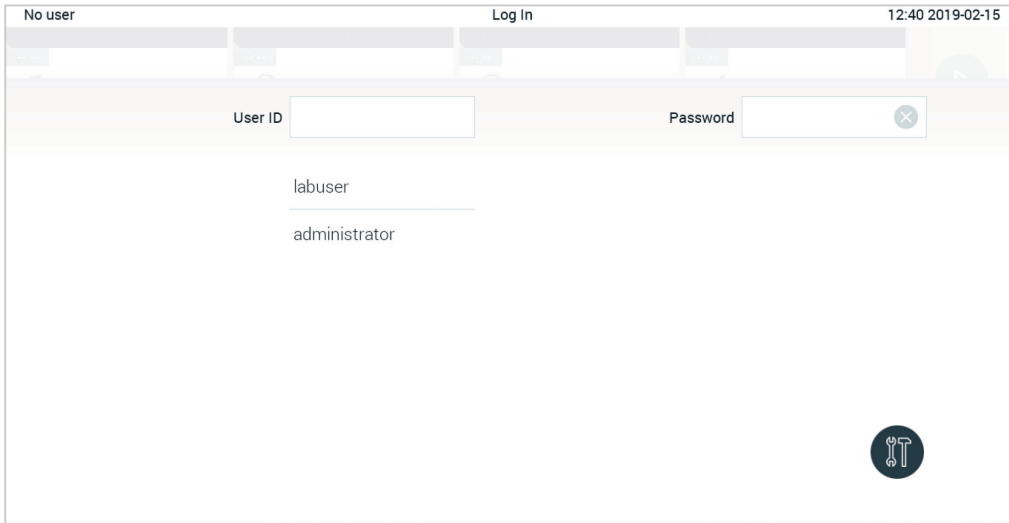

Figure 46. Login screen.

Enter the user name either by clicking on one of the names available in the list or by clicking on the **User ID** text box and entering the name using the virtual keyboard. Once the user name is entered, confirm by pressing the **check mark** on the virtual keyboard (Figure 47).

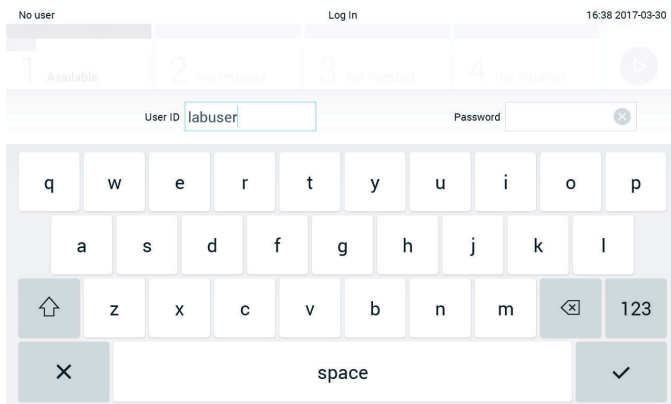

Figure 47. Virtual keyboard on touchscreen.

If the option **Require password** is selected (refer to Section 6.6), a password text box and the virtual keyboard for entering the password will be shown. If no password is required, the password text box will be grayed out.

If a user forgets his or her password, the system Administrator can reset it.

Note: If the administrator forgets their password, it can only be reset by QIAGEN Technical Services, which requires an on-site visit by a QIAGEN service engineer. Therefore, it is recommended to create an additional administrator account.

For security reasons, if a password is entered incorrectly three times, the system will lock for one minute before the user can try to log in again.

Note: Follow your organization's cybersecurity policies for credential custody.

Note: It is strongly recommended to use a strong password following your organization's password policies.

6.2.1 Logging out

When **User Access Control** is enabled (refer to Section 6.6), users can log out at any time using the **Log Out** option in the Main Menu bar. See Section 6.1.4 for more information.

Users will be automatically logged out when the time for automatic log-off expires. This time can be configured in the **General** settings of the **Options** menu (see Section 6.8.4).

6.3 Screen saver

The QIAstat-Dx screen saver is shown after there has been no user interaction for a pre-defined period of time. This time can be configured in the **Options** menu (see Section 6.4).

The screen saver shows the availability of Analytical Modules and the remaining time until test completion (Figure 48, next page).

Note: During operations such as software update, backup, restore, archive creation, and archive opening, the screen saver and automatic log-off may be disabled. For cybersecurity reasons, it is recommended to not leave the system unattended during this time.

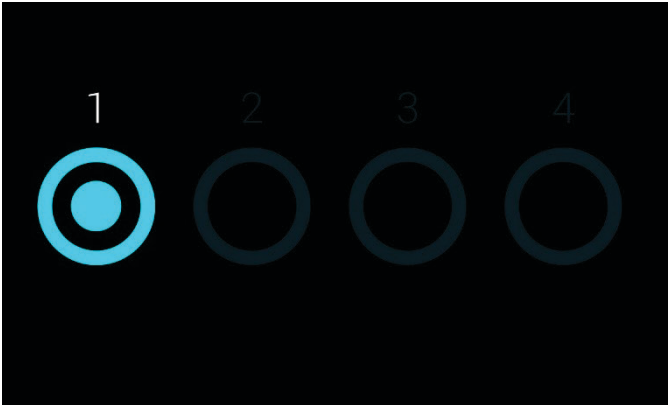

Figure 48. Screen saver showing one available Analytical Module.

6.4 Options menu

The **Options** menu is accessible from the Main Menu bar. Table 4 shows the options that are available to the user. Options that are not available will be grayed out.

Table 4. Options menu

Name	Button	Description
Archive Results		Available for administrator, service technician, and laboratory supervisor users
User Management		Available for users with rights to manage users and user profiles.
Assay Management		Available for users with rights to manage assays.
System Configuration		Available for users with the rights to configure the system.
Change Password		Available if User Access Control is enabled.

6.5 Archive results

Selected results can be archived with a subsequent removal option to free some memory space of the QIAstat-Dx Analyzer or implement your organization's policy on data retention. Archived files contain all important data of test runs (e.g., curve data, results of analytes, overall result data, etc.) and can be viewed at any time on each QIAstat-Dx Analyzer instrument (refer to Section 6.5.2).

The archive functionality is accessible via the options menu. It is possible to either create archives with or without removal option or load an archive (See Section 6.5.1).

Note: When viewing test results of an archive only limited functionality is available (refer to Section 6.5.2 for more information).

6.5.1 Create archive

6.5.1.1 Archive file creation without removal function

For archive file creation, filter the results which should be archived. Press **Create Archive** and filter for the desired start date and end date. The selected result number is displayed on the screen. Up to 250 results can be archived within one archive file.

It is possible to select only already HIS/LIS uploaded and expired results for archive file creation. Press **HIS/LIS Uploaded** to activate this option and press **Create Archive** (Figure 49).

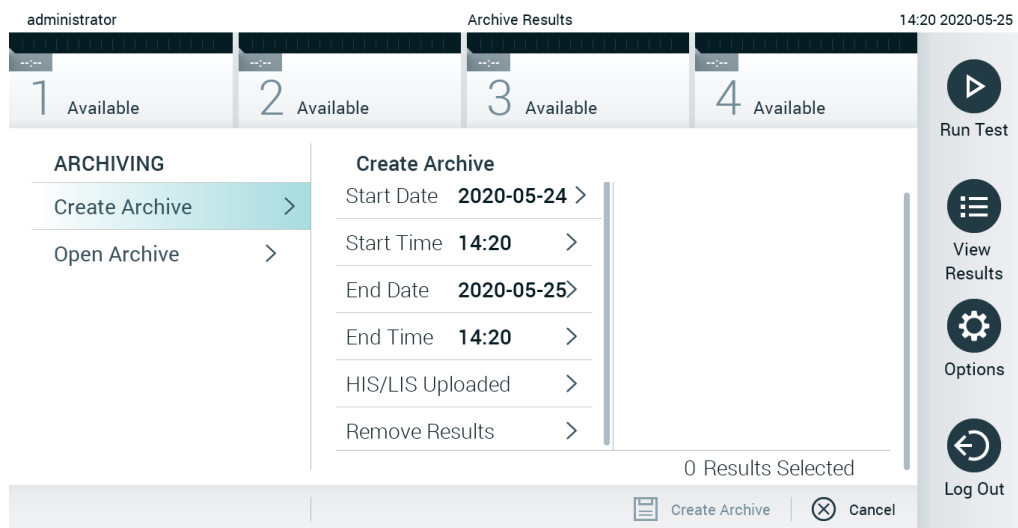

Figure 49. Create archive options

Note: It is recommended to use the delivered USB storage device for short-term data storage and transfer. The use of a USB storage device is subject to restrictions (e.g. the memory capacity or the risk of overwriting), which should be considered before usage.

Note: The screen saver functionality is inactive during an archive creation. If the User Access Mode is enabled, no re-login for user authentication is enforced. It is recommended to not leave the QIAstat-Dx Analyzer unattended during archive creation.

6.5.1.2 Archive file creation with remove function

IMPORTANT: Archived and removed results are no longer present on the QIAstat-Dx Analyzer and will not be part of a system backup file. It is strongly recommended to perform a system backup first before continuing with archive file creation using the removal functionality. Refer to Section 6.8.1.1 for system backup creation.

If selected results shall be archived and removed from the QIAstat-Dx Analyzer, proceed with archive file creation as described below and activate the removal function.

Press on **Remove Results** and activate the removal. If the archive file creation was successful, the selected results will be automatically removed from the QIAstat-Dx Analyzer (Figure 50).

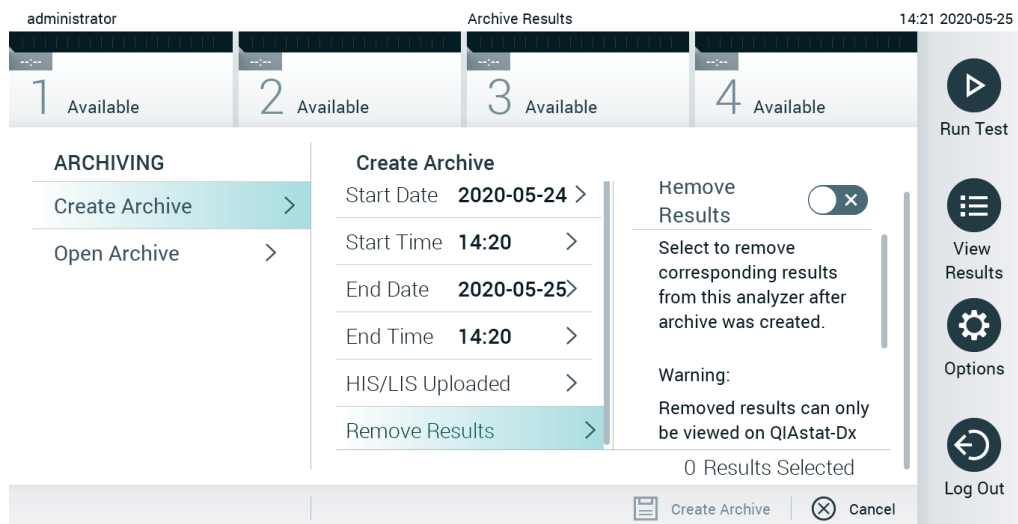

Figure 50. Remove results option screen

Note: Removed results are no longer present in the QIAstat-Dx Analyzer. The print and report functionality and a HIS/LIS upload is not possible after successful removal.

Note: It is recommended to use the delivered USB storage device for short-term data storage and transfer. The use of a USB storage device is subject to restrictions (e.g. the memory capacity or the risk of overwriting), which should be considered before usage.

Note: The screen saver functionality is inactive during an archive creation. If the User Access Mode is enabled, no re-login for user authentication is enforced. It is recommended to not leave the QIAstat-Dx Analyzer unattended during an archive creation.

6.5.2 Open archive

Archive files created with the current or older version of the QIAstat-Dx application software can be opened for viewing only. Press **Open Archive** and load desired archive file. After successful loading of an archive, press on **View Archive**. During the archive results viewing, no new runs can be started. Close the archive file with the **Close Archive** button to regain regular functionality (Figure 51, next page).

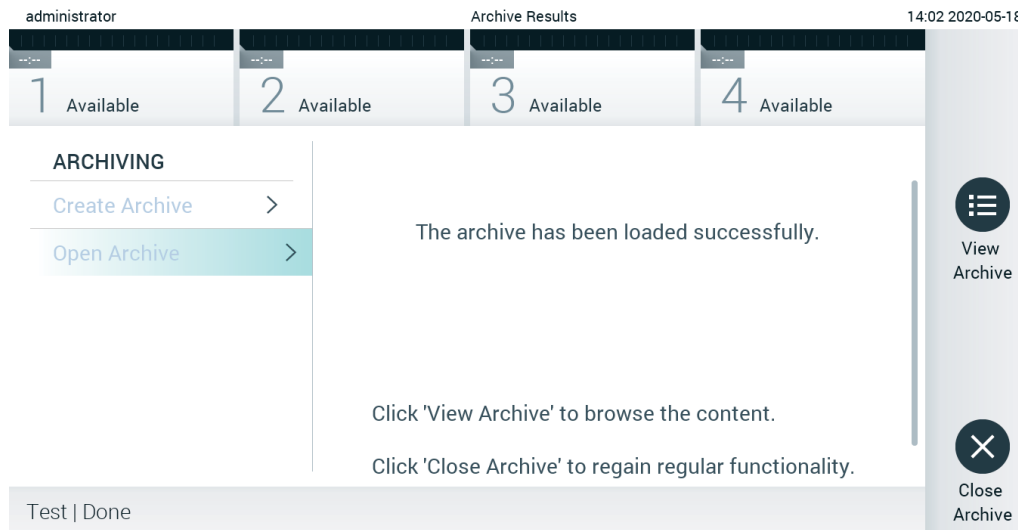

Figure 51. Open archive screen

Note: It is recommended to use the delivered USB storage device for short-term data storage and transfer. The use of a USB storage device is subject to restrictions (e.g. the memory capacity or the risk of overwriting), which should be considered before usage.

6.6 User management

The QIAstat-Dx application software is flexible in supporting different usage scenarios. For the management of users and rights, the following modes are available:

- “Single User” mode: **User Access Control** is disabled and no control of the users that log into the QIAstat-Dx Analyzer 1.0 is performed. All QIAstat-Dx Analyzer 1.0 functions and features will be available without any restrictions to all users.
- “Multi-User” mode: **User Access Control** is enabled, and users must log in before performing any action on the QIAstat-Dx Analyzer 1.0. The actions they are allowed to perform are limited and defined according to their user profiles.

Note: The **User Management** option is only available to users with “Administrator” or “Laboratory Supervisor” profiles.

Note: **User Access Control** can be enabled and disabled in the **General** settings under **System Configuration** in the **Options** menu.

The **User Management** option permits users with “Administrator” and “Laboratory Supervisor” profiles to add new users to the system, define their rights and user profiles, and to activate or inactivate users.

Note: It is strongly recommended to enable the **User Access Control**. In the single-user mode, the user exhibits all administration rights without control of users that log into the QIAstat-Dx Analyzer. All functions and features will be available without any restrictions. In addition, it is strongly recommended to create at least one user account without an "Administrator" role at first login. If a single user of QIAstat-Dx Analyzer aggregates different user roles, including the "Administrator" role, there is a high risk that access to the software will be completely blocked if this user forgets the password.

Table 5 displays the user profiles that are available in the QIAstat-Dx Analyzer 1.0.

Table 5. User profiles available in the QIAstat-Dx Analyzer 1.0

User Profile	Rights	Example
	Full	Instrumentation/IT responsibility
Laboratory Supervisor	Add new users Introduce new assays in the assay collection Running assays and viewing results from all users and generating support packages	Laboratory head
Advanced User	Running assays Viewing detailed results of own user tests (e.g., amplification plots, etc.) and generating support packages	Microbiologist, laboratory technician
Basic User	Running assays Viewing non-detailed results of own user tests (e.g., positive/negative results) and generating support packages	Healthcare provider (e.g., nurse, doctor, general practitioner, etc.)

6.6.1 Accessing and managing the list of users

Follow the steps below to access and manage the system users:

1. Press the **Options** button and then the **User Management** button to configure users. The **User Management** screen appears in the content area of the display (Figure 52).

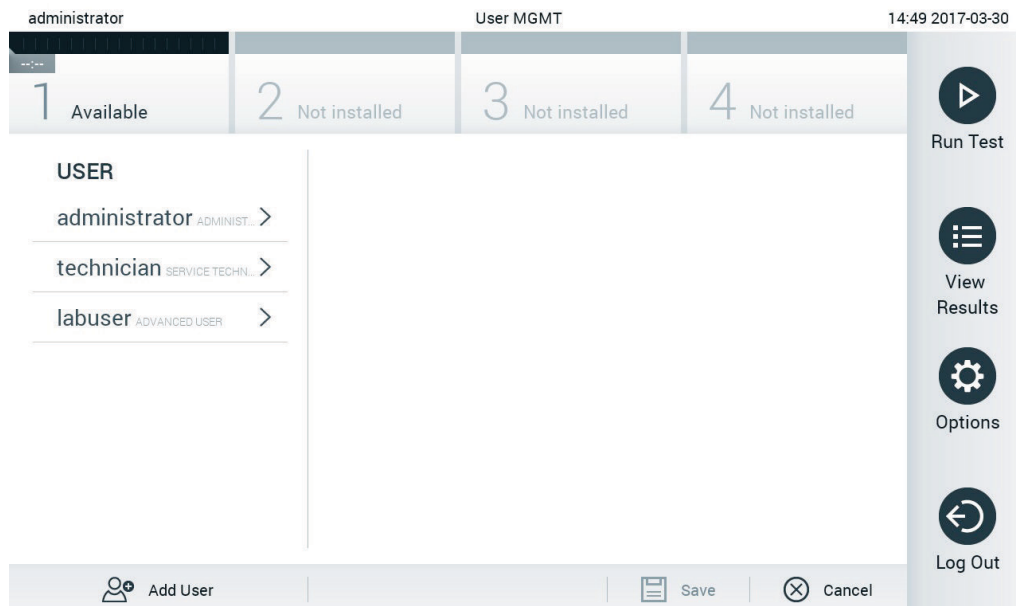

Figure 52. The User Management screen.

2. Select the user to manage from the list in the left column of the content area (Figure 53).

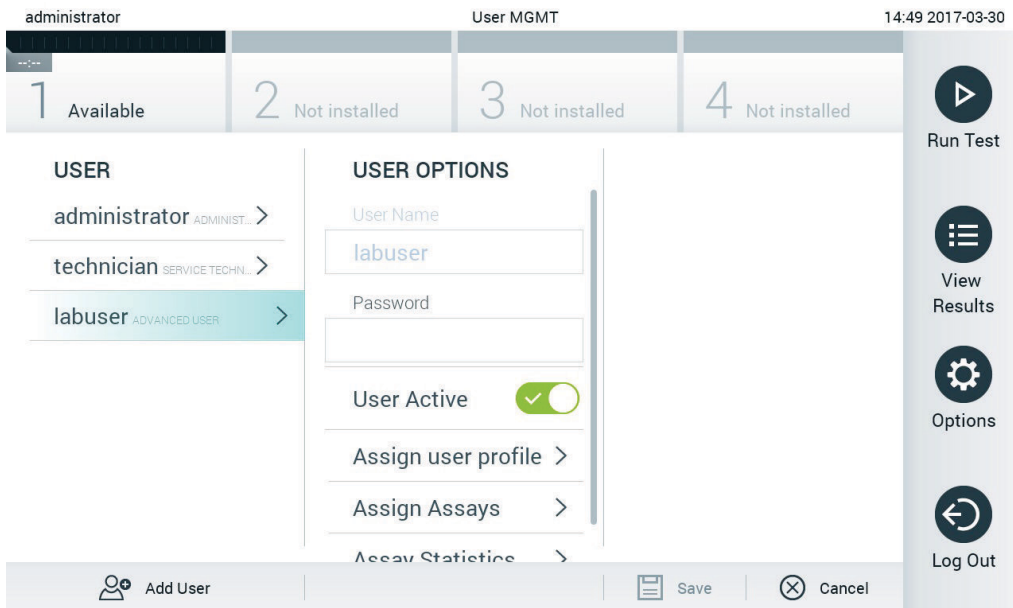

Figure 53. Selecting and managing users.

3. Select and edit the following options as needed

- **User Name:** Allows viewing the user name.
- **Password:** Allows changing the password for that user
- **User Active (yes/no):** Allows changing whether the user is active or not. Inactive users are not allowed to log in or perform any action on the system.
- **Assign User Profile:** Allows assigning a different user profile for that user (e.g., Administrator, Laboratory Supervisor, Advanced User, Basic User). Select the appropriate user profile from the list on the right of the content area (Figure 54, next page).

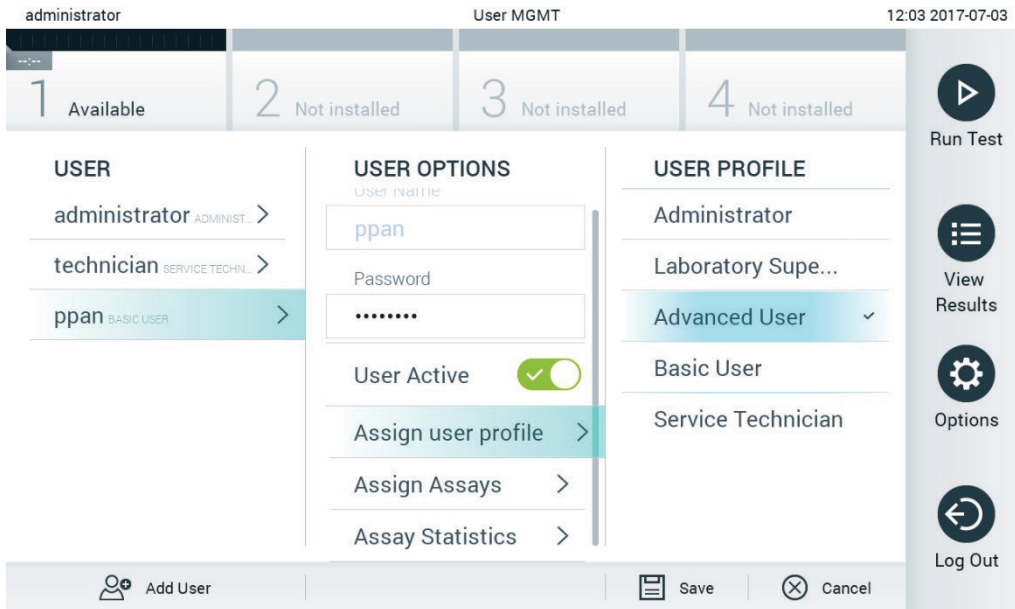

Figure 54. Assigning user profiles to users.

- **Assign Assays:** Allows defining the assays from the assay database that the user is permitted to run. Select the assays from the list on the right of the content area (Figure 55).

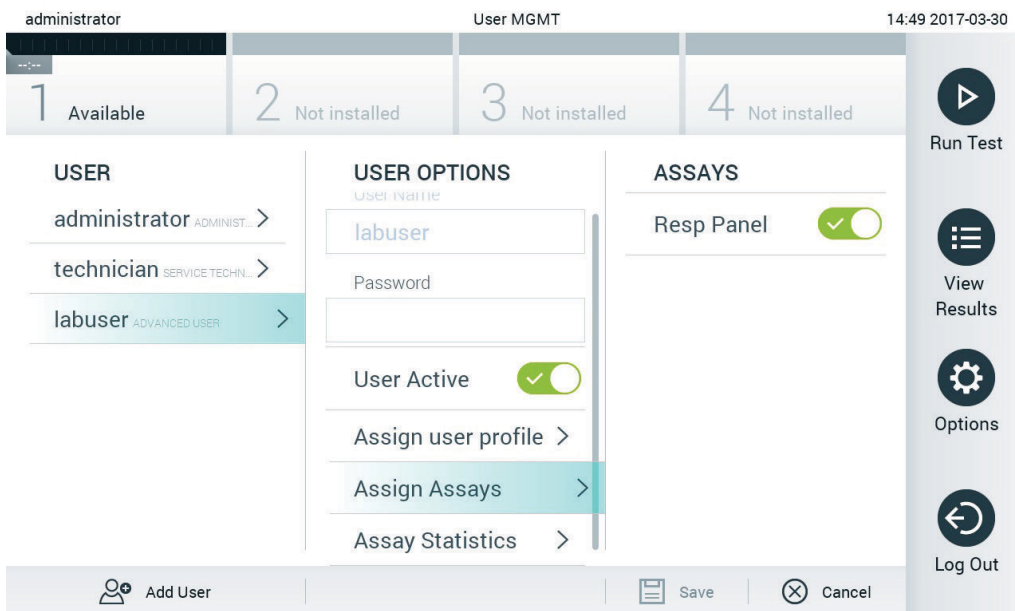

Figure 55. Assigning assays to users.

- **Assay Statistics:** Shows the number of times an assay was run by the selected user (Figure 56).

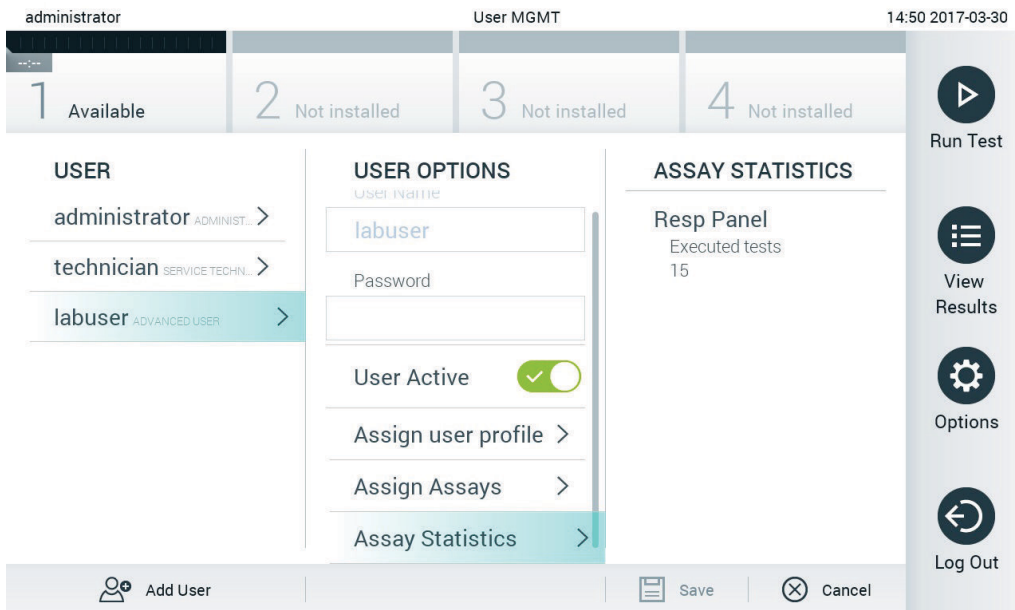

Figure 56. Viewing assay statistics.

4. Press **Save** and **Confirm** to save the changes. Alternatively, press **Cancel** and **Confirm** to discard the changes.

6.6.2 Adding users

Follow the steps below to add new users to the QIAstat-Dx Analyzer 1.0:

1. Press the **Options** button and then the **User Management** button to configure users. The **User Management** screen appears in the content area of the display (Figure 57, next page).

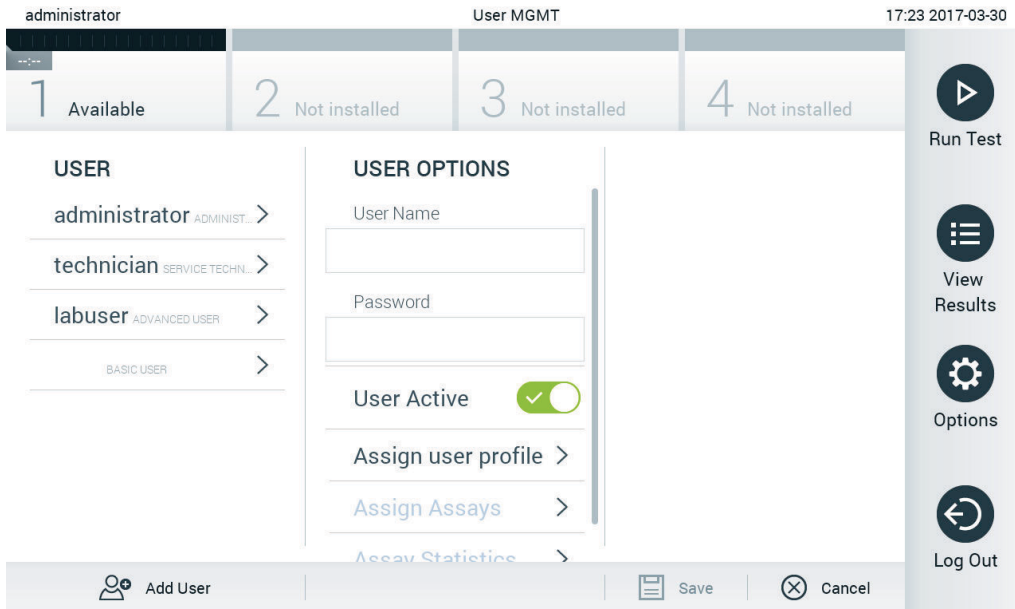

Figure 57. Adding a new user.

2. Press **Add User** at the bottom left of the screen to add a new user to the system.
3. Use the virtual keyboard to enter the **User Name** and **Password** for the new user.
4. Press **Assign User Profile** and assign the appropriate user profile (from the list on the right of the content area) to the new user (Figure 58).

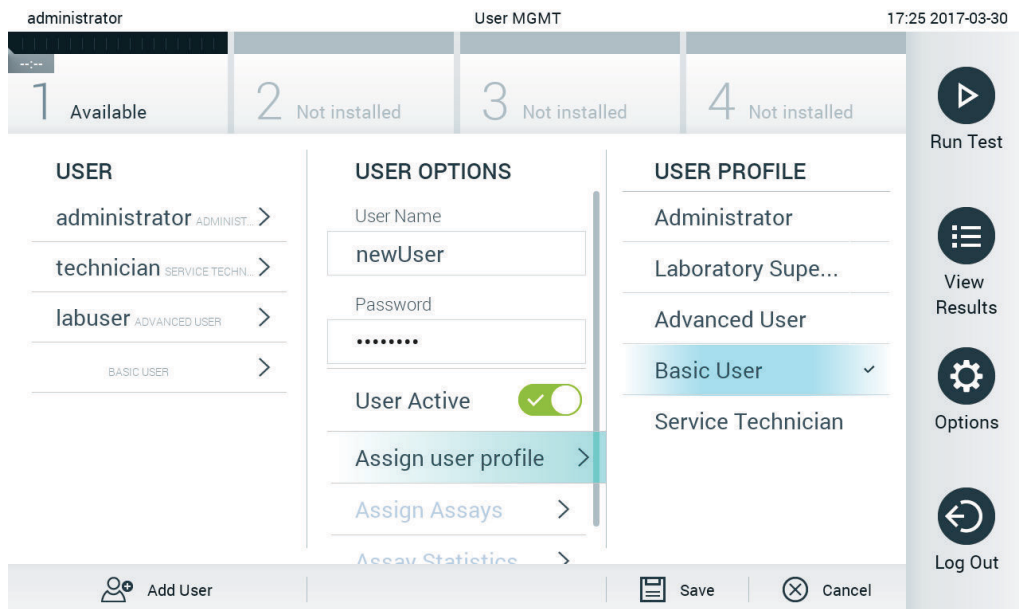

Figure 58. Assigning a user profile to a new user.

5. Press **Assign Assays** and select the assays (from the displayed assay list) that the user is allowed to run.
6. Press **Save** and **Confirm** to save and store the new information. The new user has been set up and is immediately allowed to log in to the QIAstat-Dx Analyzer 1.0.

6.7 Assay management

From the **Assay Management** menu, it is possible to manage assays and access assay-related information and statistics.

Note: The **Assay Management** option is available only to users with “Administrator” or “Laboratory Supervisor” profiles.

6.7.1 Managing available assays

Follow the steps below to manage assays on the QIAstat-Dx Analyzer 1.0:

1. Press the **Options** button and then the **Assay Management** button to access the **Assay Management** screen. The available assays are listed in the first column of the content area (Figure 59).

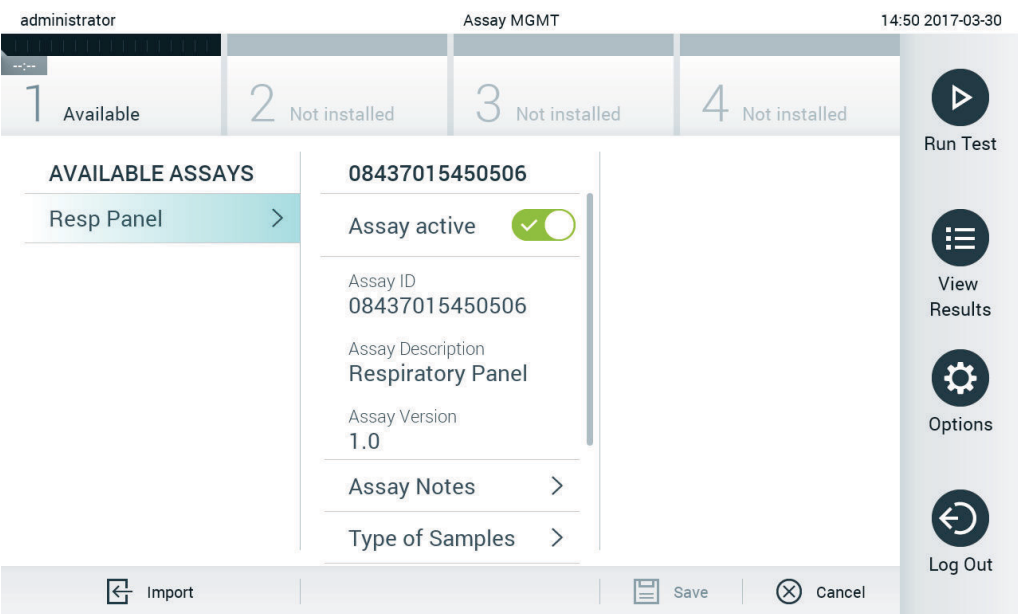

Figure 59. Managing available assays.

2. Press the name of the assay to manage in the left column of the content area.

3. Select one of the options listed in Table 6.

Table 6. Options for managing assays

Option	Description
Assay Active	This button allows setting an assay to active or inactive. Note: It is only possible to test QIAstat-Dx assay cartridges for a particular assay if the assay is active.
Assay ID	Provides the assay identification number.
Assay Description	Provides the assay name.
Assay Version	Provides the assay version.
LIS assay name	Provides information about the LIS assay.
Assay Notes	Provides additional information about the assay.
Type of Samples	Provides a list of the various sample types supported by the assay.
List of Analytes	Provides a list of analytes that are detected and identified by the assay.
List of Controls	Provides the lists of control analytes that are implemented in the assay.
Assay Statistics	Provides the number of tests ever run on the QIAstat-Dx Analyzer 1.0 for the selected assay, as well as the number of positive, negative, failed, and canceled tests.
Epidemiology report	Provides the option to create an epidemiology report for a selected date range.

6.7.2 Creating an epidemiology report

An epidemiology report is a report where, for a selected assay and time interval, test results for each pathogen of that assay are counted.

Follow the steps below to create an epidemiology report:

1. Follow steps 1 to 3 from Managing available assays.
2. Scroll to the bottom of the options listed in Table 6 and click on **Epidemiology Report**.
3. Select a **From Date**, the start date from which results are counted, and an **Until Date**, an end date until results are counted.

Note: The from and until date are included in the count.

4. Click on **Save Report**.
5. Select a location where the report should be saved.

Note: In the Epidemiology Report, the column "Positive results" refers to pathogens that have been "detected", and the column "Negative results" refers to pathogens that have been "not-detected". "Equivocal" results are listed in a separate column.

6.7.3 Importing new assays

Follow the steps below to import new assays to the QIAstat-Dx Analyzer 1.0:

1. Insert the USB storage device that contains the Assay Definition File(s) to import into the USB port of the QIAstat-Dx Analyzer 1.0.

Note: It is recommended to use the delivered USB storage device for short-term data storage and transfer. The use of a USB storage device is subject to restrictions (e.g. the memory capacity or the risk of overwriting), which should be considered before usage.

2. To import the new assay(s) to the QIAstat-Dx Analyzer 1.0, press the **Options** button and then the **Assay Management** button. The **Assay Management** screen appears in the content area of the display (Figure 60).

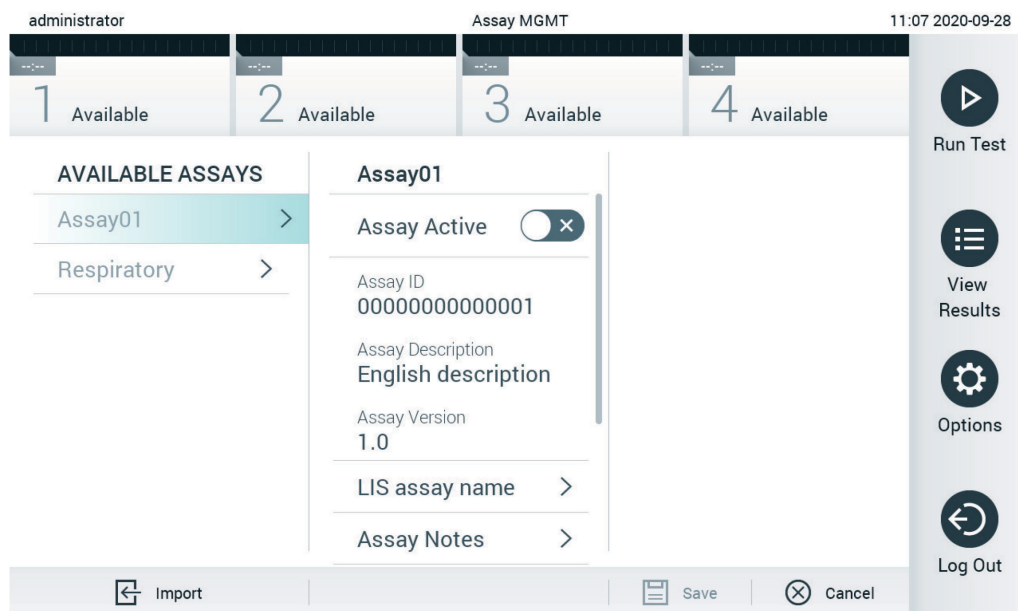

Figure 60. Assay management screen.

3. Press the **Import** icon at the bottom left of the screen.
4. Select the Assay Definition File from the USB storage device corresponding to the assay to be imported. To be recognized by the system, the Assay Definition File must be contained in the root folder.
5. A dialog will appear to confirm upload of the file.
6. A dialog may appear to override the current version by a new one. Press yes to override.
7. The assay becomes active by selecting Assay Active (Figure 61, next page).

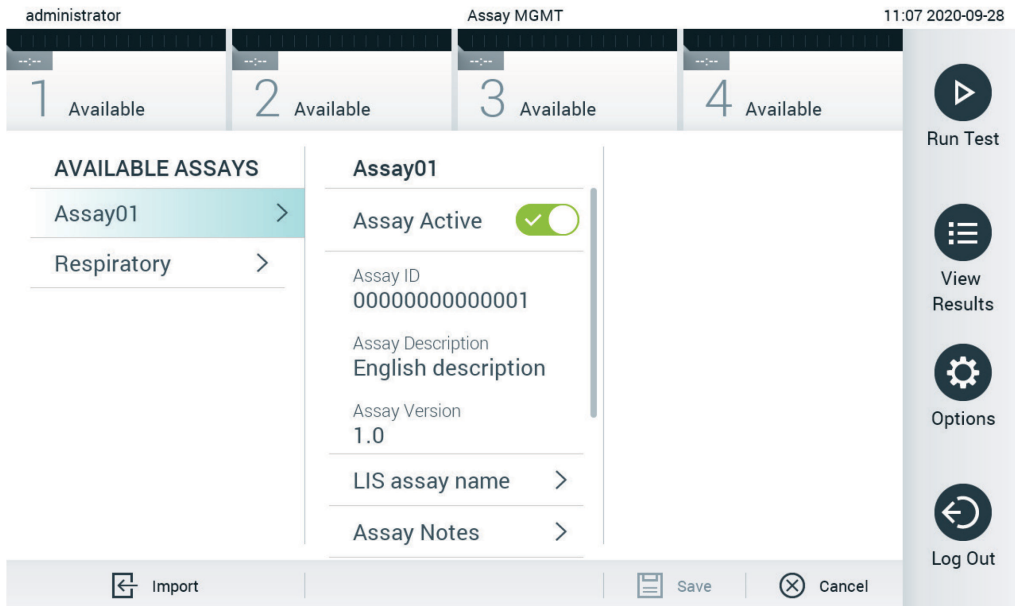

Figure 61. Activating the assay.

6.8 Configuring the QIAstat-Dx Analyzer 1.0

In the **System Configuration** menu, it is possible to manage the QIAstat-Dx Analyzer 1.0 system and define region-specific parameters.

6.8.1 Regional settings

Follow the steps below to configure the regional settings of the QIAstat-Dx Analyzer 1.0:

1. Press the **Options** button and then the **System Configuration** button.
2. Select **Regional** from the **Settings** list in the left column. Select and define the settings listed in Table 7 (next page) as needed.

Table 7. Available regional settings

Setting	Description
Date	Defines the system date (year, month, day) (Figure 62). This setting is synchronized automatically when the device is connected to a QIASphere Base.
Time	Defines the system time (hours, minutes). This setting is synchronized automatically when the device is connected to a QIASphere Base.
Time Zone	Defines the system time zone. This setting might need to be adjusted manually once a connection to a QIASphere Base is established, as it is currently not automatically synchronized.
Date format	Defines the date format. The following options are available (Figure 63, next page): DD-MM-YYYY DD-MM-YY MM-DD-YYYY YYYY-MM-DD (default) YY-MM-DD
Date separator	Defines the date separator. The following options are available (Figure 64, next page): "." "_" (default) "/" "-" ":"
Time format	Defines the time format. The following options are available (Figure 65, next page): 24 hours (hh:mm:ss) (default) 12 hours (hh:mm:ss a.m./p.m.)
Language	English (default)

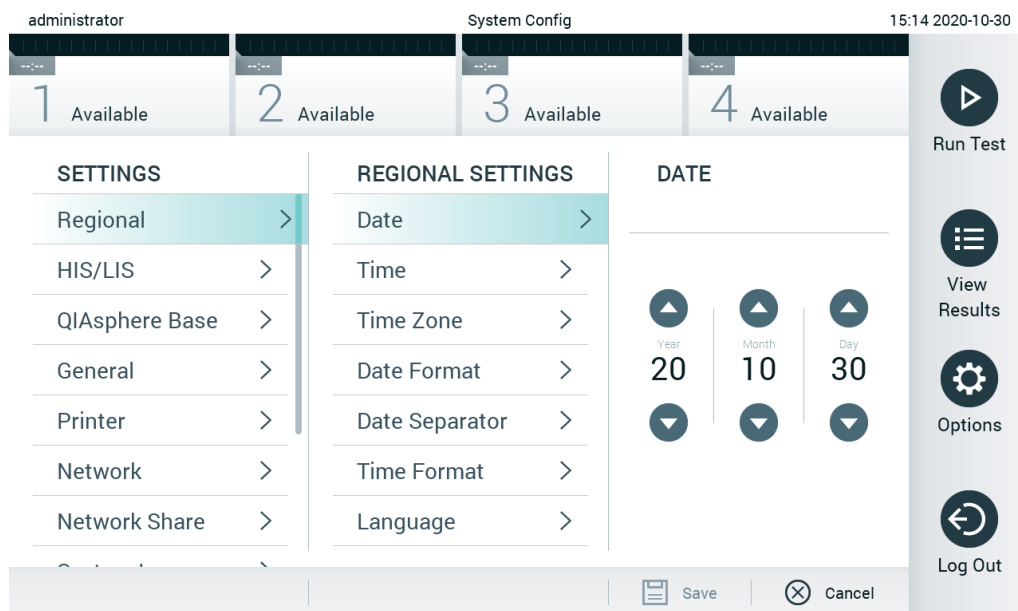

Figure 62. Setting the system date.

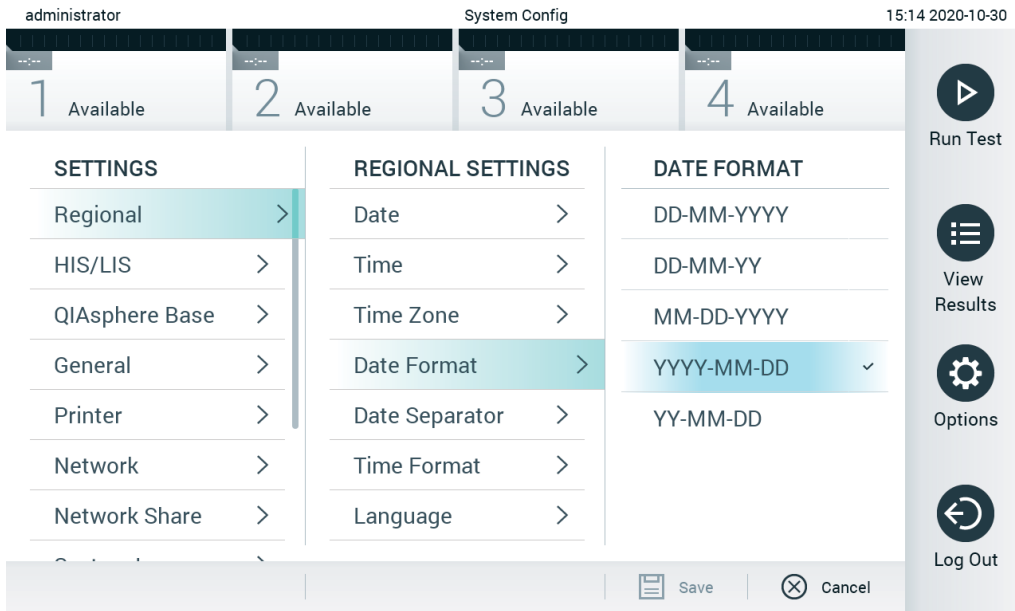

Figure 63. Setting the system date format.

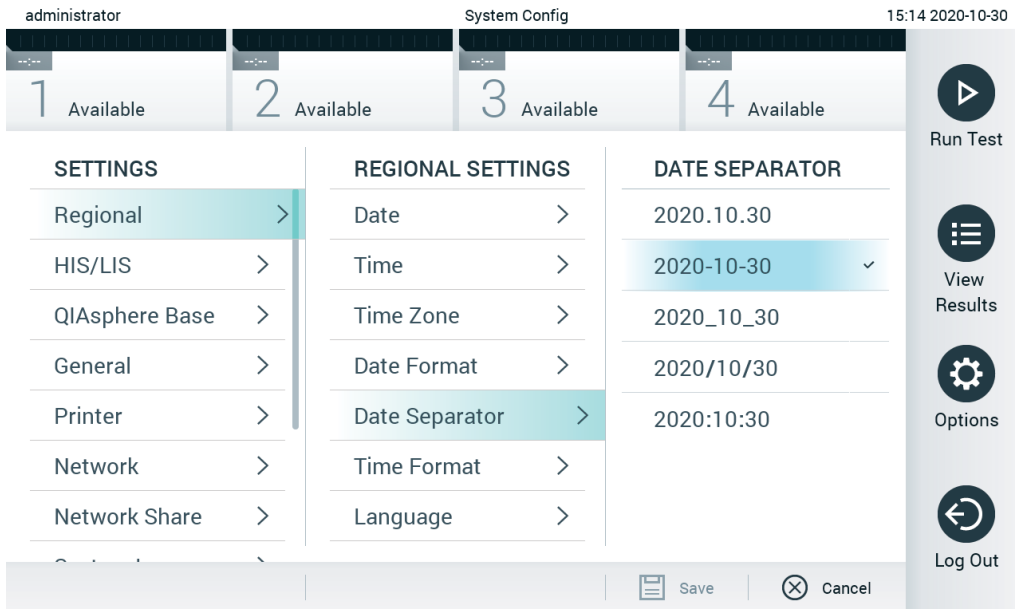

Figure 64. Setting the system date separator.

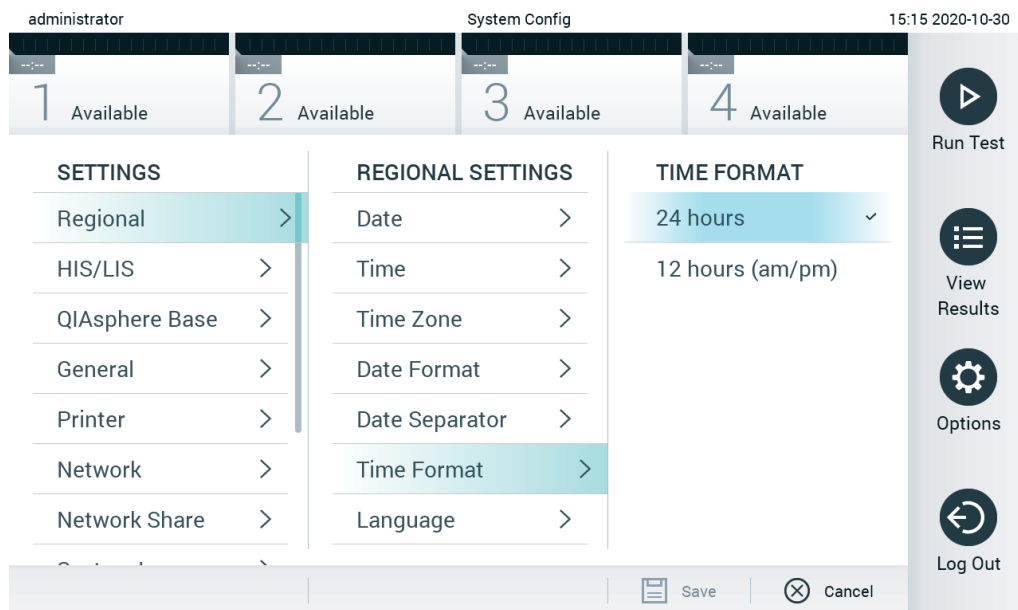

Figure 65. Setting the system time format.

6.8.2 HIS/LIS settings

Refer to Section 7.

6.8.3 QIASphere Base settings

QIASphere connects customers with QIAGEN's comprehensive digital ecosystem to deliver a unique user experience and improve laboratory efficiency and safety through cloud-based connectivity. The QIASphere system consists of the following components:

- QIASphere-ready Instruments from QIAGEN, which can be connected to the QIASphere solution
- QIASphere App for instrument monitoring, available for mobile devices and web browser for desktop use
- QIASphere Base which is an IoT (Internet of Things) gateway device for secure network communication.

For more information, see [QIAGEN.com/QIASphere](https://www.qiagen.com/QIASphere).

Follow the steps below to connect the QIASphere Base to a QIASphere Base. In order to connect to a QIASphere Base, ensure that both devices are connected to the same network.

1. Press the **Options** button and then the **System Configuration** button.
2. Select **QIASphere Base** from the settings list in the left column (Figure 66).

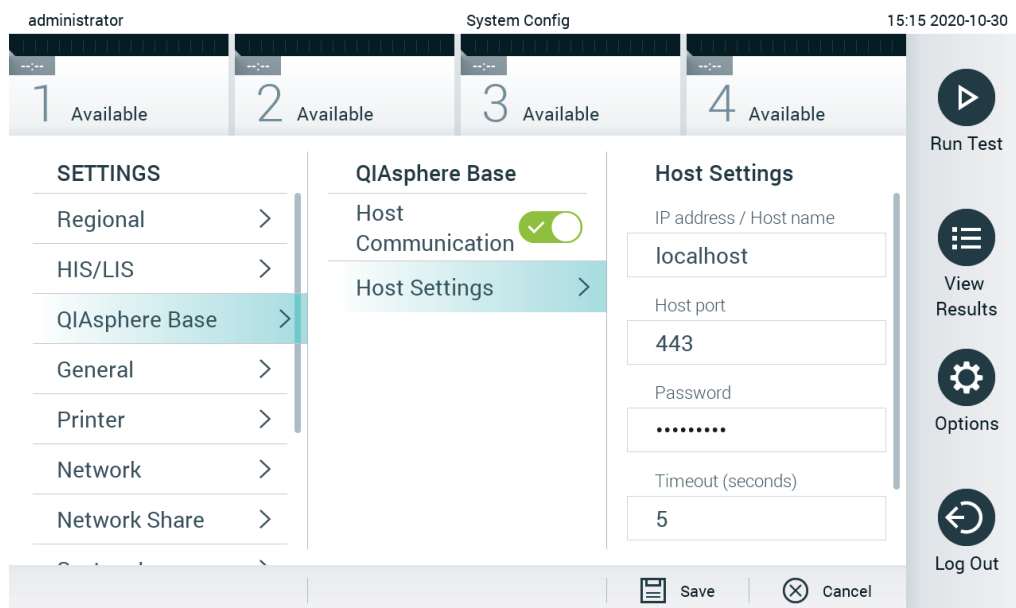

Figure 66. Configuring the QIASphere Base connection

3. Select and define the options in Table 8 according to instructions from the network administrator.

Table 8. QIASphere base settings

Option	Description
Enable Host Communicator	Enables the connection to a QIASphere Base. The submenu Host Settings is only active if "Host Communicator" is enabled.
IP address/Host name	Defines the IP address under which the QIASphere Base can be contacted.
Host port	Defines the host port under which the QIASphere base can be contacted.
Password	Defined the password which is required to connect to a QIASphere Base.
Timeout (seconds)	Defines the timeout period in seconds after which a connectivity check is aborted when the QIASphere Base cannot be contacted.
Check connectivity	A press on the button checks whether a connection to the QIASphere Base can be established.

Note: The current status of the QIASphere Base might not be immediately displayed in the QIASphere app.

Note: The time and date of the device is synchronized automatically once a connection to a QIASphere Base is established. The time zone needs to be adjusted manually though.

6.8.4 General settings

Follow the steps below to modify the general settings of the QIAstat-Dx Analyzer 1.0:

4. Press the **Options** button and then the **System Configuration** button.
5. Select **General** from the **Settings** list in the left column. Select and define the options listed in Table 9 as needed.

Table 9. Available general settings

Setting	Description
User Access Control	Enables the User Access Control , which requires all users to log into the system and limits users to only perform the actions allowed by their user profile. When this option is not enabled, it is not possible to distinguish between users. All features will be available as if they were run by the "Administrator" profile. This option is enabled by default.
Automatic log-off time	Only active if User Access Control is enabled. This setting defines the time interval after which a user is automatically logged out of the system because the QIAstat-Dx Analyzer 1.0 hasn't received user input. The allowed range is 5 minutes up to 99:59 hours. Default: 30 minutes. User input, such as a cursor movement, cursor click, press of a key on an external keyboard or a touch on the touchscreen, resets the automatic log-off time. If a user has entered data (for example, in the Run Test screen) when the automatic log-off occurs, these data will be lost.
Require password before executing assay	Only active if User Access Control is enabled. With this setting activated, all users will be required to enter a password after pressing the Confirm button before executing an assay.
Use Patient ID	With Use Patient ID activated, the QIAstat-Dx Software will provide the option for users to enter a Patient ID or scan a Patient ID when preparing to run a test (see Section 5.3).
Prefer Patient ID Bar Code	Determines if users will be prompted to scan the Patient ID using the bar code reader first. Default: Disabled.
Patient ID Mandatory	Only active if Use Patient ID is enabled. When activated, users will be required to enter a patient ID before executing an assay. When not activated, users can leave the patient ID data field empty. Default: Disabled.
Sample ID Mandatory	When activated, users will be required to enter a Sample ID before executing an assay. When not activated, users can leave the Sample ID data field empty and a unique Sample ID will be automatically generated by the QIAstat-Dx Analyzer 1.0. Default: Disabled.
Prefer Sample ID Bar Code	Determines if users are prompted to scan the Sample ID using the bar code reader first. Default: Disabled.
Exclude Modules	Allows the possibility to exclude specified Analytical Modules from running tests. This may be useful in the event that a module is suspected of failure. Default: Disabled.
Number of Results Per Page	This setting defines the number of results shown per page in the View Results screen.
Show Previously Logged-in User IDs	Only active if User Access Control is enabled. When this setting is enabled, the list of previously logged-in users will be displayed on the login screen. Default: Enabled.
Require Password to Log In	Only active if User Access Control is enabled. When this setting is enabled, all users must enter their password to log in. When disabled, only the User ID will be required to log in. Default: Enabled.
Max. Number of Technical Log files	Number of technical log files can be changed by the user.
Restore Factory Default	Enables resetting the system back to all factory default settings.

6.8.5 Printer settings

The **Printer** settings option enables selection of the system printer. The QIAstat-Dx Analyzer 1.0 allows use of networked printers or printers connected to the Operational Module via the USB ports on the back of the instrument.

Follow the steps below to modify the printer settings of the QIAstat-Dx Analyzer 1.0:

1. Press the **Options** button and then the **System Configuration** button.
2. Select **Printer** from the settings list in the left column.
3. Select a printer from the list of available printers (Figure 67).

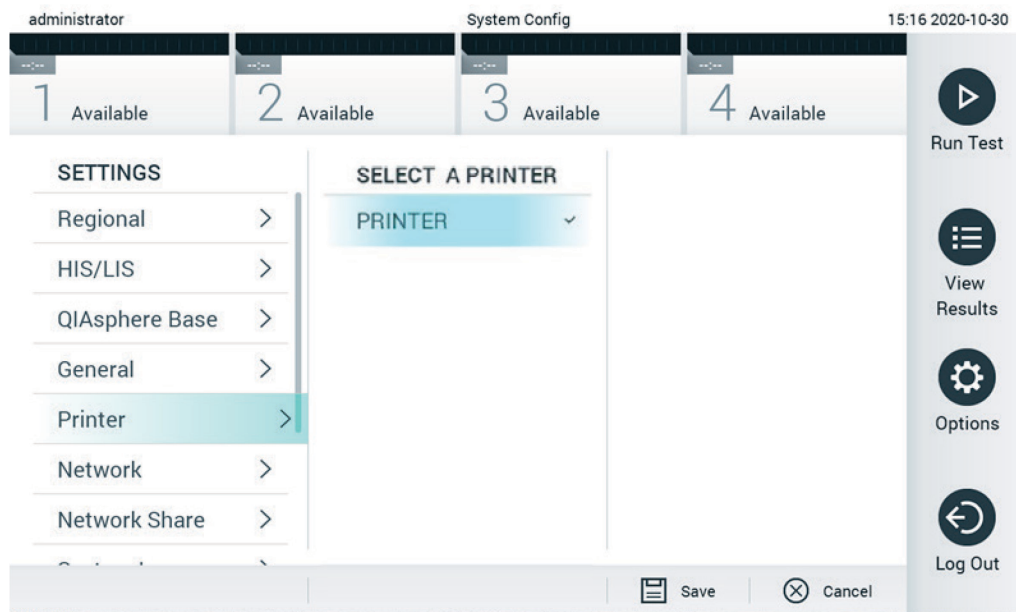

Figure 67. Selecting a system printer.

For printer installation via USB or ethernet, refer to Appendix 11.1.

6.8.6 Network settings

The **Network** option enables connection of the QIAstat-Dx Analyzer 1.0 to a network, allows access to networked printers, and provides connectivity to the HIS/LIS. Contact the network administrator for details on how to configure the network settings.

Follow these steps to define the network settings:

4. Press the **Options** button and then the **System Configuration** button.
5. Select **Network** from the settings list in the left column (Figure 68, next page).



Figure 68. Configuring the network settings.

6. Select and define the options in Table 10 according to instructions from the network administrator.

Table 10. Network settings

Option	Description
Enable IPv6	Enables the use of the IPv6 protocol. The submenu IPv6 Settings is only active if "Enable IPv6" is enabled.
Obtain IPv6 address automatically	Allows the unit to acquire the IPv6 address from the network using DHCP.
IPv6 Address	Defines the manually configured IPv6 address of the Operational Module. This option is only active if "Obtain IPv6 address automatically" is disabled.
Subnet Prefix Length	Defines the IPv6 subnet prefix length. This option is only active if "Obtain IPv6 address automatically" is disabled.
Enable IPv4	Enables the use of the IPv4 protocol. The submenu IPv4 Settings is only active if "Enable IPv4" is enabled.
Obtain IPv4 address automatically	Allows the unit to acquire the IPv4 address from the network using DHCP.
IPv4 Address	Defines the manually configured IPv4 address of the Operational Module. This option is only active if "Obtain IPv4 address automatically" is disabled.
Subnet Mask	Defines the IPv4 subnet prefix length. This option is only active if "Obtain IPv4 address automatically" is disabled.
Default Gateway	Defines the IPv6 or IPv4 default gateway, depending on which is enabled. This option is only active if either "Obtain IPv6 address automatically" or "Obtain IPv4 address automatically" is disabled.
Obtain DNS address automatically	Allows the unit to acquire the DNS configuration from the network using DHCP.
Preferred DNS Server	Defines the primary DNS server. This option is only active if "Obtain DNS address automatically" is disabled.
Alternate DNS Server	Defines the secondary DNS server. This option is only active if "Obtain DNS address automatically" is disabled.

6.8.7 Network Share

The **Network Share** option enables selection of network shares. The QIAstat-Dx Analyzer 1.0 allows use of network shares that run on Windows® operating systems.

Follow the steps below to add a network share of the QIAstat-Dx Analyzer 1.0:

1. Press the **Options** button and then the **System Configuration** button.
2. Select **Network Share** from the settings list in the left column.
3. Press the **Add new share** button (Figure 69).

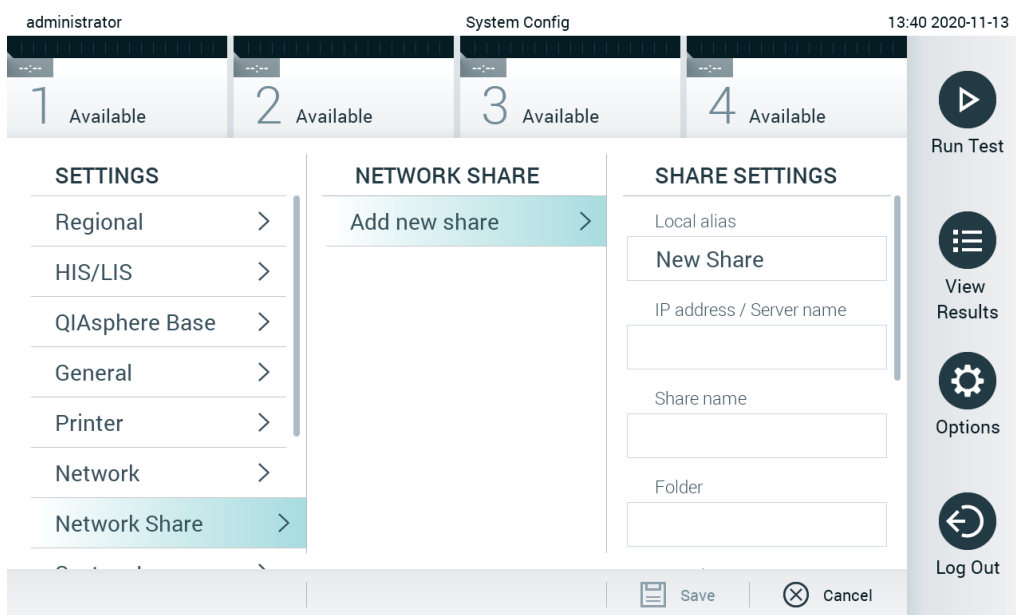

Figure 69. Adding a network share.

4. Select and define the options in Table 11 (next page) according to instructions from the network administrator.

Table 11. Network share settings

Option	Description
Local Alias	Defines a name for the entry under which the share can be selected in other menus of the application (e.g., when saving a backup).
IP address/Server name	Defines the server or its IP address that is hosting the network share.
Share name	Defines the name of the network share.
Folder	Defines a path to a specific folder on the network share. A path uses "/" (without quotation marks) to separate folder names, (e.g. "folder/subfolder").
Domain name	Defines the domain to which the server hosting the network share is assigned.
User name	Defines the username that is used to connect to the network share. Please note that the user must have rights to write onto the network share.
Password	Defines the password which is used to authenticate the username.
Check connectivity	Checks whether a connection to the network share can be established. A pop-up with the results of the connection attempt is shown.
Remove Share	Removes the configured Network Share. Note: This button is only visible when editing an existing Network Share.

6.8.8 System log

The system log records general information about the use of the Operational and Analytical Modules, such as adding or removing users and adding or removing assays, logins, logouts, starts of tests, etc. Press the **Options** button, then the **System Configuration** button and then **System Log** to access the system log information. The "System Log Capacity" is shown in the center of the screen followed by the log content. Press **Export Log File** to export the content (Figure 70).

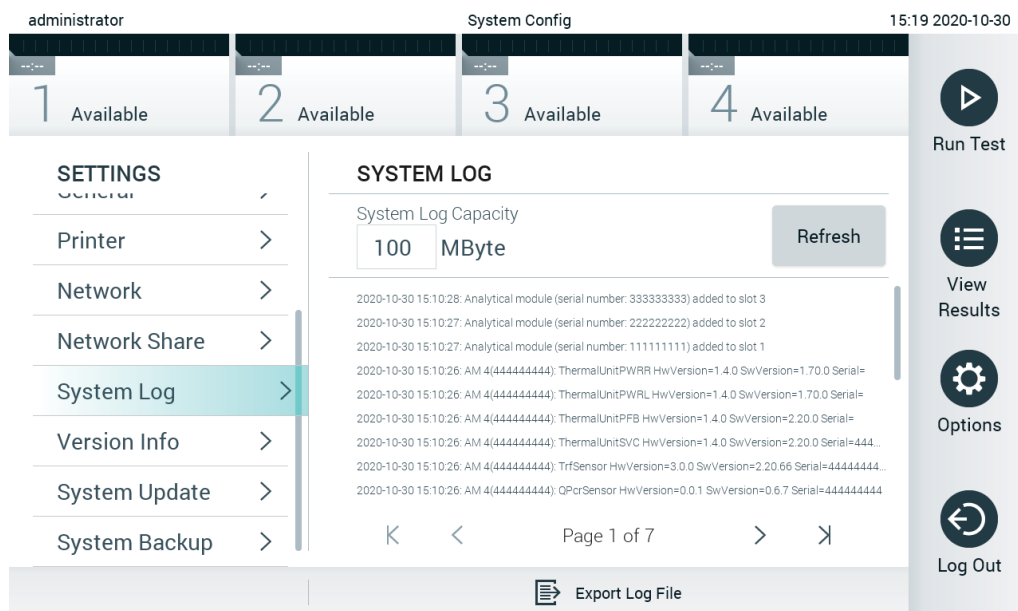

Figure 70. Accessing the system log.

Note: For complete support information of a test or all failed tests, it is recommended to use the support package functionality instead (refer to 5.4.7).

6.8.9 Version information and software license agreement

Press the **Options** button, then the **System Configuration** button and then **Version Info** to view the QIAstat-Dx Software version, the serial numbers, the firmware versions for the installed Analytical Modules, and the software license agreement.

6.8.10 System update

IMPORTANT: Software version 1.1 or higher is required for updating to software version 1.4.

To ensure the best performance, please confirm you are using the most up-to-date software version. Contact QIAGEN Technical Services at support.qiagen.com for assistance with software upgrades.

To update the QIAstat-Dx Analyzer 1.0 system, press the **Options** button, then the **System Configuration** button and then **System Update**. Select the appropriate **.dup** file stored on a USB storage device to update the system to a newer version. A message will appear recommending that a system backup be performed first (refer to Section 6.8.11) (Figure 71). After the update, the user may be required to shut down the QIAstat-Dx Analyzer 1.0 and start it again.

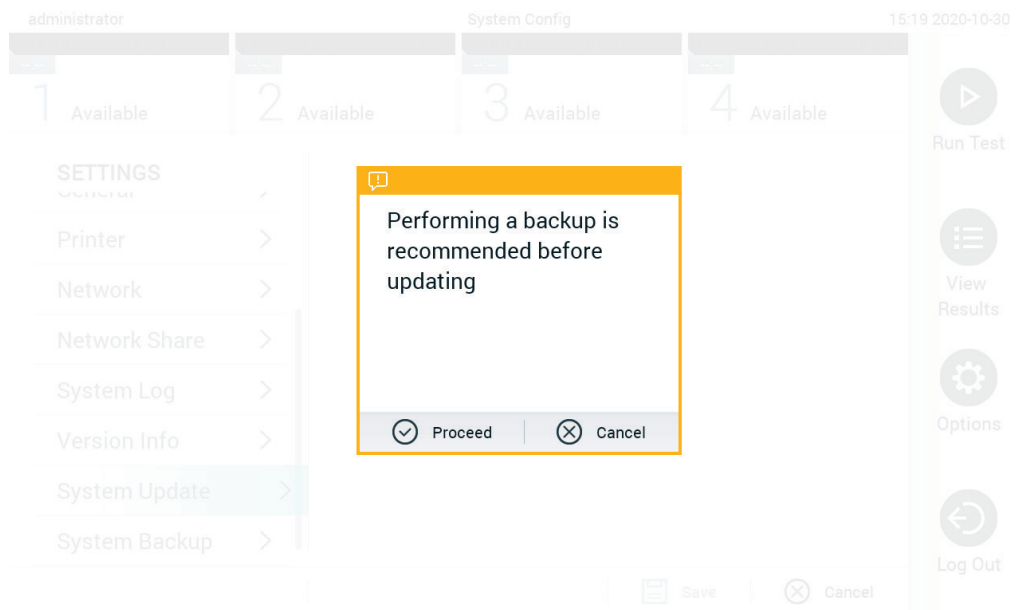

Figure 71. Performing the system update.

Note: To ensure a timely software update from software version 1.2 or lower, it is recommended to follow the subsequent procedure prior to and after the update:

Prior to the update, navigate from the home screen to "Options" > "System Config" > under "Settings" select "General" > under "General Settings"

1. Scroll down (swipe up) and look for the field "Number of results per page"
2. Press on the field "Number of results per page"
3. Change the value to "100" and press enter
4. Press "Save" on the bottom bar to save the settings.

After the software update is completed, return the number of results per page to the previous setting. To do this, navigate from the home screen to "Options" > "System Config" > under "Settings" select "General" > under "General Settings"

5. Scroll down (swipe up) and look for the field "Number of results per page"
6. Press on the field "Number of results per page"
7. Change the value from "100" to "the value previously displayed" and press enter
8. Press "Save" on the bottom bar to save the settings.

Note: It is recommended to use the delivered USB storage device for short-term data storage and transfer. The use of a USB storage device is subject to restriction (e.g. the memory capacity or the risk of overwriting), which should be considered before usage.

Note: The screen saver functionality is inactive during a system update. If the User Access Mode is enabled, no re-login for user authentication is enforced. It is recommended to not leave the QIAstat-Dx Analyzer unattended during a system update.

6.8.11 System backup

To back up the QIAstat-Dx Analyzer 1.0 system, press the **Options** button, then the **System Configuration** button and then **System Backup** (Figure 72, next page). Insert a USB storage device into the front USB port or configure a network share (See Network Share).

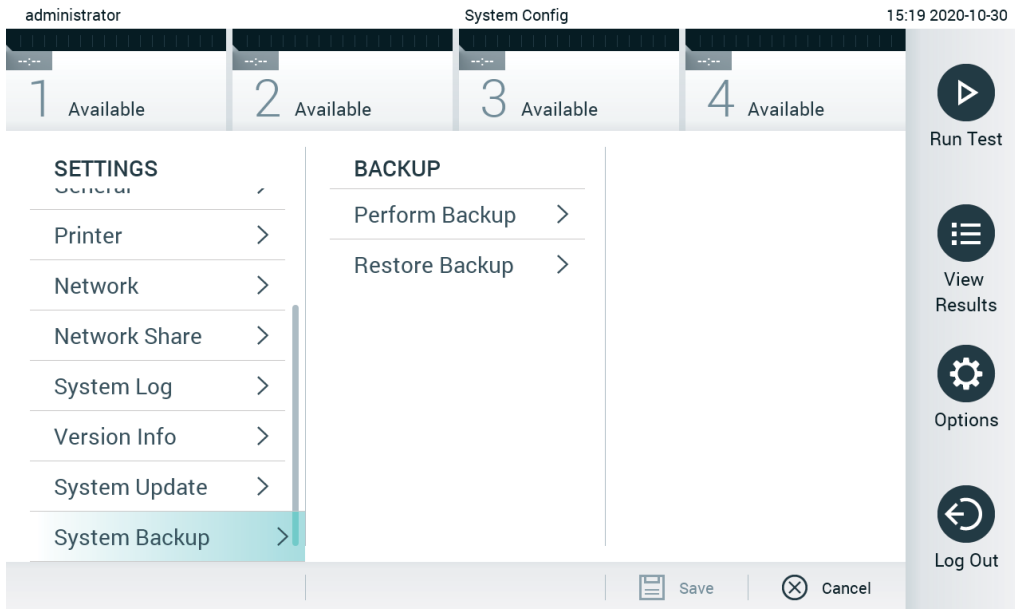

Figure 72. Performing a system backup.

Press the **Make Backup** button. A file with the extension **.dbk** will be generated with a default file name. The file can be saved on either a USB drive or a network share.

To restore a backup, press the **Restore Backup** button and select the appropriate backup file with a **.dbk** extension from the connected USB storage device. A message will appear recommending that a backup be created before restoring.

Note: It is strongly recommended to perform regularly system backups according to your organization’s policy for the availability of data and the protection of data from loss.

Note: The screen saver functionality is inactive during a system backup creation. If the User Access Mode is enabled, no re-login for user authentication is enforced. It is recommended to not leave the QIAstat-Dx Analyzer unattended during a backup creation.

Note: It is recommended to use the delivered USB storage device for short-term data storage and transfer. The use of a USB storage device is subject to restrictions (e.g. the memory capacity or the risk of overwriting), which should be considered before usage.

6.9 Change passwords

To change a user password, press the **Options** button and then **Change Password**. First enter the current password in the text field (Figure 73, next page) and then enter the new password into the **New Password** field. Type the new password again in the **Confirm Password** field (Figure 74, next page).

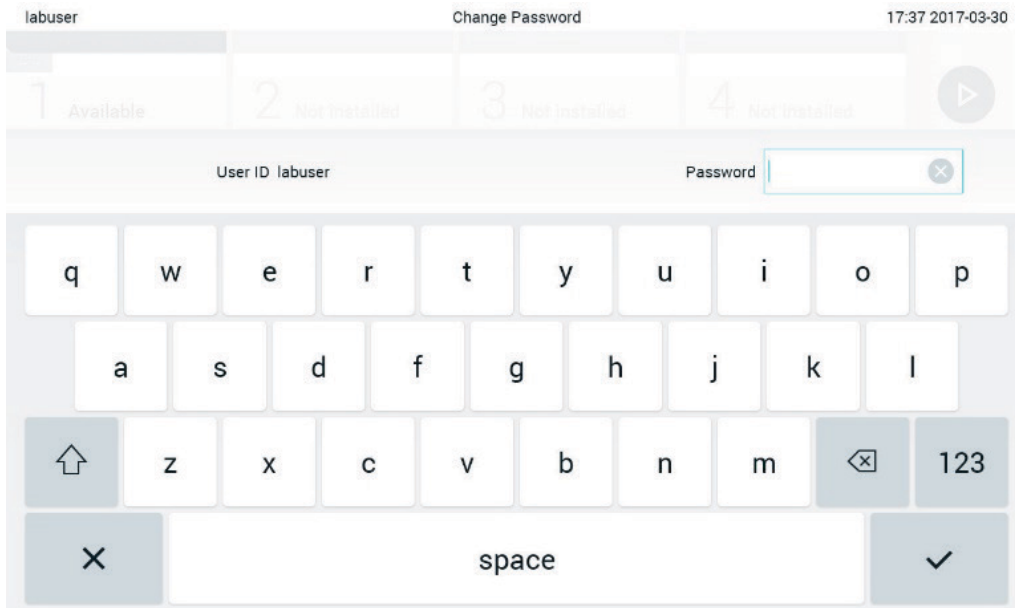

Figure 73. Entering current password.

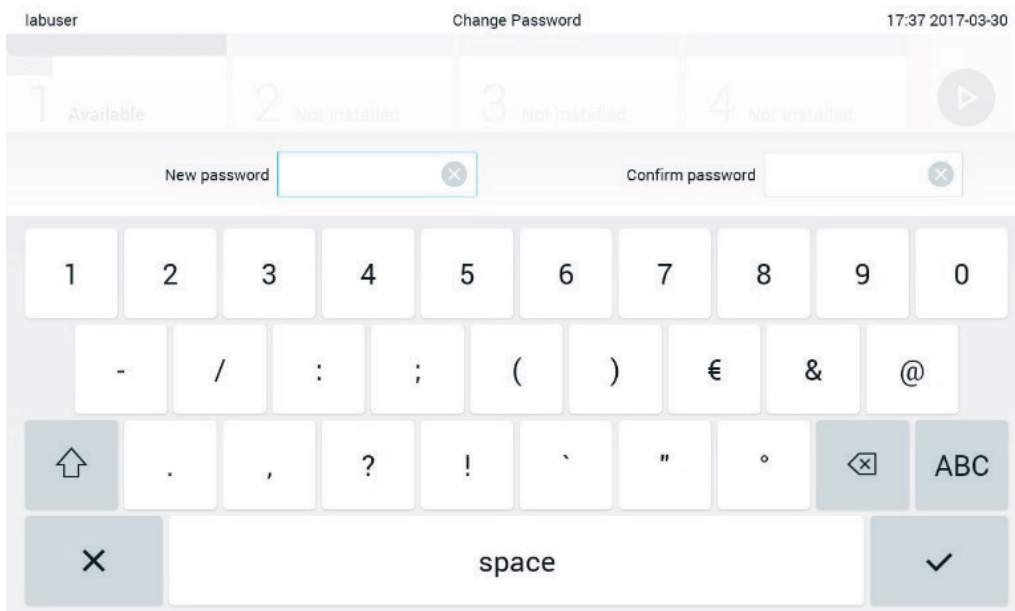

Figure 74. Entering and confirming new password.

After three failed attempts to enter a password, the password entry field will be deactivated for one minute, and a dialog will appear with the message "Password failed, please wait for 1 minute to try it again".

Note: It is strongly recommended to use a strong password following your organization's password policies.

6.10 QIAstat-Dx Analyzer 1.0 system status

The status of the Operational and Analytical Modules is indicated by the color of the status indicators (LEDs) on the front of the QIAstat-Dx Analyzer 1.0.

The Operational Module can display any of the following status colors:

Table 12 explains the status lights that may be displayed on the Operational and Analytical Modules.

Table 12. Descriptions of status lights

Module	Status light	Description
Operational	OFF	QIAstat-Dx Analyzer 1.0 is powered OFF
	Blue	QIAstat-Dx Analyzer 1.0 is in standby mode
	Green	QIAstat-Dx Analyzer 1.0 is running
Analytical	OFF	QIAstat-Dx Analyzer 1.0 is powered OFF
	Blue	QIAstat-Dx Analyzer 1.0 is in standby mode
	Green (blinking)	QIAstat-Dx Analyzer 1.0 is initializing
	Green	Analytical Module is running
	Red	Analytical Module malfunction

6.11 Shutting down the QIAstat-Dx Analyzer 1.0

The QIAstat-Dx Analyzer 1.0 is designed to operate continuously. If the unit will not be used for a short time (less than a day), we recommend placing the QIAstat-Dx Analyzer 1.0 in standby mode by pressing the ON/OFF button on the front of the instrument. To shut down the QIAstat-Dx Analyzer 1.0 for a longer time period, power OFF the instrument using the power switch on the back of the QIAstat-Dx Analyzer 1.0.

If a user attempts to put the QIAstat-Dx Analyzer 1.0 in standby mode while the Analytical Module is running a test, a dialog will appear indicating that shutdown is not currently possible. Allow the instrument to finish running the test(s) and try shutting it down upon completion.

7 HIS/LIS Connectivity

This section describes the connectivity of the QIAstat-Dx Analyzer 1.0 with a HIS/LIS.

HIS/LIS configuration enables the connection of the QIAstat-Dx Analyzer 1.0 to a HIS/LIS to provide such functionalities as:

- Activating and configuring communication with the HIS/LIS
- Assay configuration for sending results and requesting book orders
- Running a test based on a book order
- Sending the result of a test

Note: It is recommended to follow your organization's security measures and policies for your local intranet as communication with HIS/LIS is not encrypted.

7.1 Activating and configuring communication with the HIS/LIS

1. Press the **Options** button and then the **System Configuration** button.
2. Select **HIS/LIS** from the **Settings** list in the left column. Select and define the settings listed in Table 13 as needed:

Table 13. HIS/LIS settings

Setting	Description
Host Communication	Enables the HIS/LIS connectivity. This option is disabled by default.
Host Settings	Only active if Host Communication is enabled. This setting defines the host address and port of the host. The host address allows both an IP and a name value of the host. The IP value must be 4 numbers (N.N.N.N) and N must be between 0 and 255. The transfer protocol is currently compatible with HL7 (future versions will also be with POCT1A). Hospital name is an exclusive name to define a DMS or LIS. The default Timeout is configured as 5 seconds and can be extended up to 60 seconds. This is the maximum time the QIAstat-Dx Analyzer 1.0 will wait for a message from the host. Messages queued is an indicator of the number of messages waiting in the queue. The Check connectivity button validates the connection between the QIAstat-Dx Analyzer 1.0 and the host with the IP and port filled.
Result Upload	Enables the functionality of sending results from the QIAstat-Dx Analyzer 1.0 to the host. This option is disabled by default.

(continued on next page)

Table 13. (continued from previous page)

Setting	Description
Results Upload Settings	<p>Only active if Result Upload is enabled.</p> <p>Results uploading can be performed in two modes: automatic and manual. When automatic mode is enabled, as soon as a test is complete the results are sent to the host. If automatic mode is disabled, the results can be sent manually by pressing the Upload button in the Result Summary and View Results screens. Automatic is disabled by default.</p> <p>Expire Time is the number in days that a test can be sent to the host. When set to zero, this option is disabled so the results will never expire.</p> <p>Reset Uploading clears the queue of messages waiting to be sent. This option can be helpful when many results have been sent but for various reasons the transmission needs to be canceled.</p> <p>Retry resends results that are in upload status "Error".</p> <p>Authorization can be set to a role to allow uploading of results. As default, only the Administrator role has this authorization enabled.</p>
Test Orders	<p>Enables the functionality of running a test based on a book order created in the HIS/LIS.</p> <p>This option is disabled by default.</p>
Order Settings	<p>Only active if Test Orders is enabled.</p> <p>Disabling Force Order enables running a test even if communication with the host is unavailable or if there is no book order associated with the entered sample ID. Force Order is disabled by default.</p>
Debug Logging	<p>Debug logging can only be activated/deactivated as user having administrator rights or as service technician user. It enables logging specific HL7 debug messages for HIS/LIS uploads.</p> <p>Note: It is strongly recommended to only turn the logging on for analysis during installation and to turn it off afterwards.</p>

7.2 Assay name configuration

The displayed assay name in the HIS/LIS may differ from the displayed assay name in the QIAstat-Dx Analyzer 1.0. Before using HIS/LIS functions, the following process for confirming/correcting assay names must be performed.

1. Press the **Options** button and then the **Assay Management** button to access the **Assay Management** screen. Available assays are listed in the first column of the content area.
2. Select the assay from the **Available Assays** menu.
3. Select the **LIS assay name** option. By default, the assay name should be the same for the QIAstat-Dx Analyzer 1.0 and the HIS/LIS. If the assay name in the HIS/LIS is different, it needs to be corrected to match the QIAstat-Dx Analyzer 1.0 assay name. Correct the assay name using the **LIS assay name input** text field and then press the **Save** button.

7.3 Creating a test order with host connectivity

When **Host Communication** and **Test Orders** are enabled, test orders can be downloaded from the host before a test run. Scanning or entering the sample ID automatically retrieves the test order from the host.

7.3.1 Configuration of the QIAstat-Dx Analyzer 1.0 with host connectivity

1. Press the **Options** button and then the **System Configuration** button.
2. Select **HIS/LIS** from the **Settings** list in the left column.
3. Enable **Host Communication** and configure the **Host Settings** with the host details. Press the **Check connectivity** button to confirm the connection.
4. Enable **Test Orders** and configure the **Order Settings**. There are two modes of working with test orders, with **Force Order** enabled or disabled. When **Force Order** is enabled, if the test order is not successfully retrieved from the host, then the user is not allowed to continue running the test. When **Force Order** is disabled, even if the test order is not retrieved or does not exist in the host, the user can continue with the test and a pop-up dialog box will warn the user.

7.3.2 Running a test based on a test order

1. Press the **▶ Run Test** button at the top right corner of the **Main** screen.
2. When prompted, scan the sample ID bar code using the bar code reader that is integrated into the Operational Module (Figure 75).

Note: Depending on the QIAstat-Dx Analyzer 1.0 configuration, it may also be possible to enter the sample ID using the virtual keyboard of the touchscreen. Please refer to Section 6.8.4 for further details.

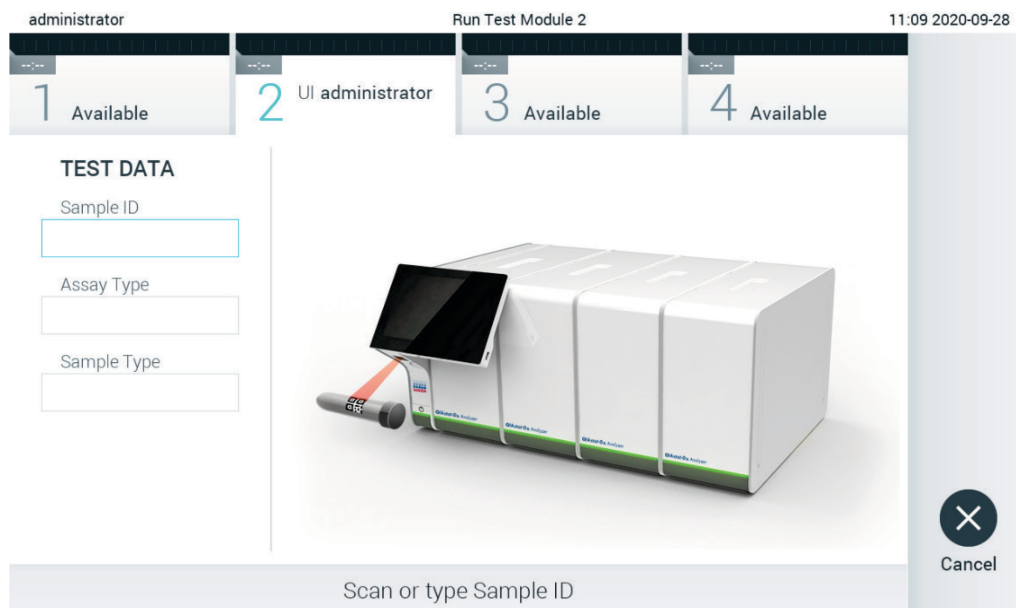

Figure 75. Scanning the sample ID bar code.

3. The sample ID will be sent to the host and while the QIAstat-Dx Analyzer 1.0 waits for a test order, the message “Getting order...” is displayed (Figure 76).

Note: If the test order is not successfully retrieved from the host, and if **Force Order** is enabled, the user is not allowed to continue running the test. If **Force Order** is disabled, even if the test order is not retrieved, the user can continue with the test (a pop-up dialog box will display a warning message). Refer to Section 9.2 for more information on warnings and errors.

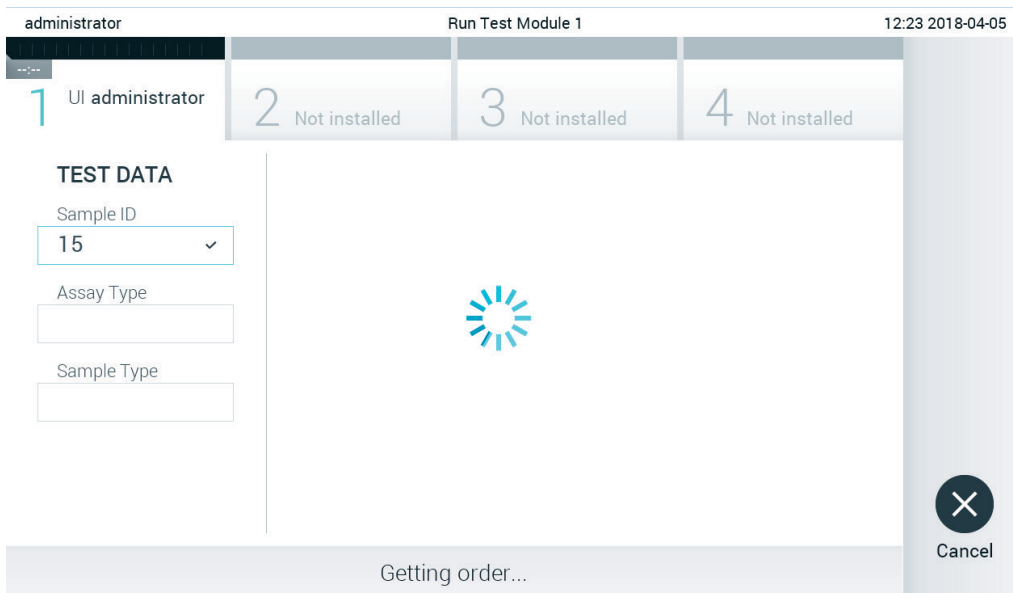

Figure 76. Display during test order retrieval.

4. When the test order has been successfully received from the host, “Scan cartridge for assay <assay_name> and book order <order_number>” is displayed. Scan the bar code of the specified QIAstat-Dx assay cartridge (Figure 77, next page).

Note: If the host returns more than one test order for a sample ID, the message “Scan cartridge for book order <order_number>” is displayed. If the scanned QIAstat-Dx assay cartridge does not match the book order, the test run cannot continue, and an error will be displayed. Refer to Section 9.2 for more information on warnings and errors.

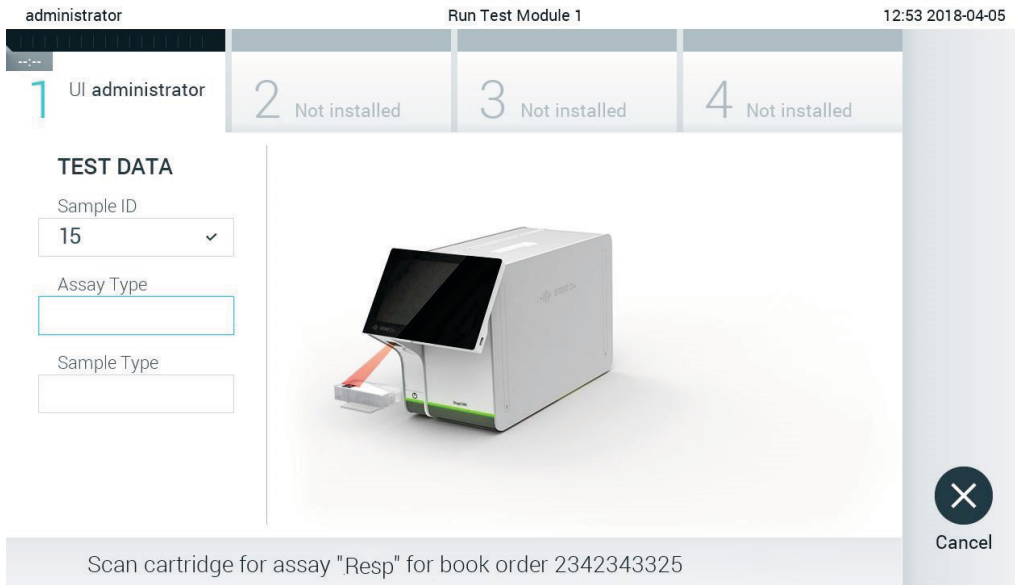

Figure 77. Scanning the QIAstat-Dx assay cartridge bar code.

- The **Assay Type** field will be automatically entered and, if required, an appropriate **Sample Type** must be manually selected from the list (Figure 78).

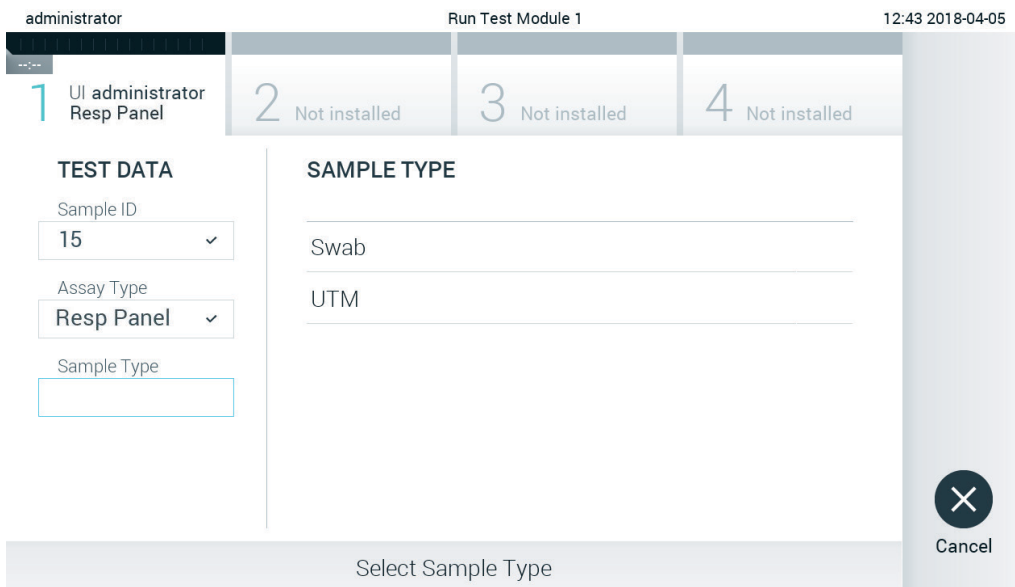

Figure 78. Selecting sample type.

- Refer to Section 5.3 and complete steps 5–11.

7.4 Uploading a test result to the host

When **Result Upload** and **Results Upload Settings** are enabled, test results can be uploaded to the host either automatically or manually.

Configuration of QIAstat-Dx Analyzer 1.0 for uploading a test result automatically to the host

1. Press the **Options** button and then the **System Configuration** button.
2. Select **HIS/LIS** from the **Settings** list in the left column.
3. Enable **Host Communication** and configure the **Host Settings** with the host details. Press the **Check connectivity** button to confirm the connection.
4. Enable **Result Upload** and configure the **Result Upload Settings**. Enable **Automatic upload**.

7.4.1 Uploading a test result automatically to the host

After the test is completed, the result will be automatically uploaded. The Upload Status is shown in the **Test Data** section of the results **Summary** screen and in the  **Upload** column of the **View Results** screen (Figure 79).

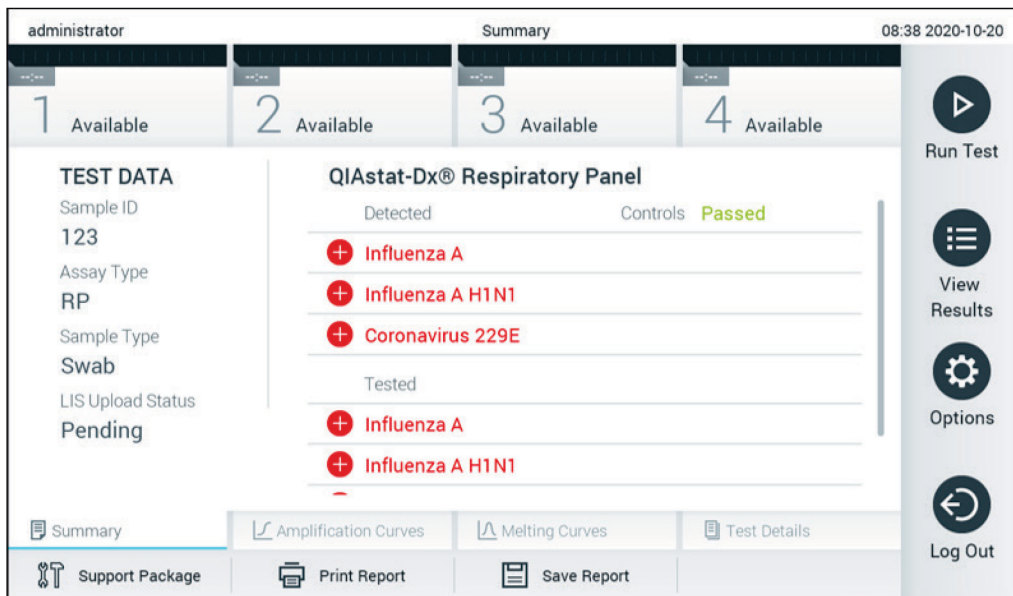



Figure 79. Results Summary screen.

To view the Upload Status for previous tests that are stored in the results repository, press  **View Results** from the Main Menu bar. The  **Upload** column displays the Upload Status (Figure 80).

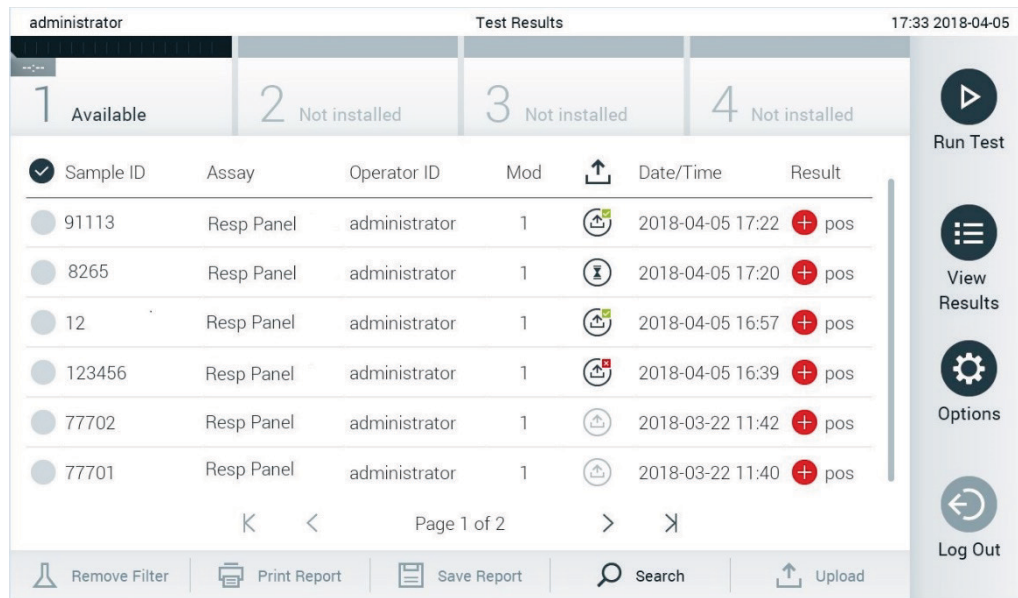

Figure 80. View Results screen.

Possible Upload Statuses that may be displayed are described in Table 14. Upload Status shows the result of the upload, the Name is shown in the result **Summary** screen and the Icon is displayed in the **View Results** screen.

Table 14. Description of upload statuses.

Name	Icon	Description
Pending		Result not uploaded yet.
Uploading		Result being uploaded.
Uploaded (timestamp)		Result successfully uploaded, with date and time of upload.
Error		Error uploading result (timeout, ...).
Re-Uploading		Result being sent again.
Expired (previously uploaded)		Result cannot be uploaded anymore. It was sent successfully at least once.
Expired (never uploaded)		Result cannot be uploaded anymore. It was never sent.

7.4.2 Configuration of QIAstat-Dx Analyzer 1.0 for uploading a test result manually to the host



1. Press the **Options** button and then the **System Configuration** button.
2. Select **HIS/LIS** from the **Settings** list in the left column.

3. Enable **Host Communication** and configure the **Host Settings** with the host details. Press the **Check connectivity** button to confirm the connection.
4. Enable Result Upload and configure the Result Upload Settings. Disable Automatic upload.

7.4.3 Uploading a test result manually to the host

After the test is completed, the result can be uploaded manually from the result **Summary** screen or the **View Results** screen.

To upload the result from the result **Summary**, screen press the  Upload **Upload** button.

To upload the result from the **View Results** screen, select one or more test results by pressing the **gray circle** to left of the sample ID. A **checkmark** will appear next to selected results. To deselect test results, press the **checkmark**. The entire list of results can be selected by pressing the  checkmark circle in the top row. After selecting the results for upload, press the  Upload **Upload** button (Figure 81).

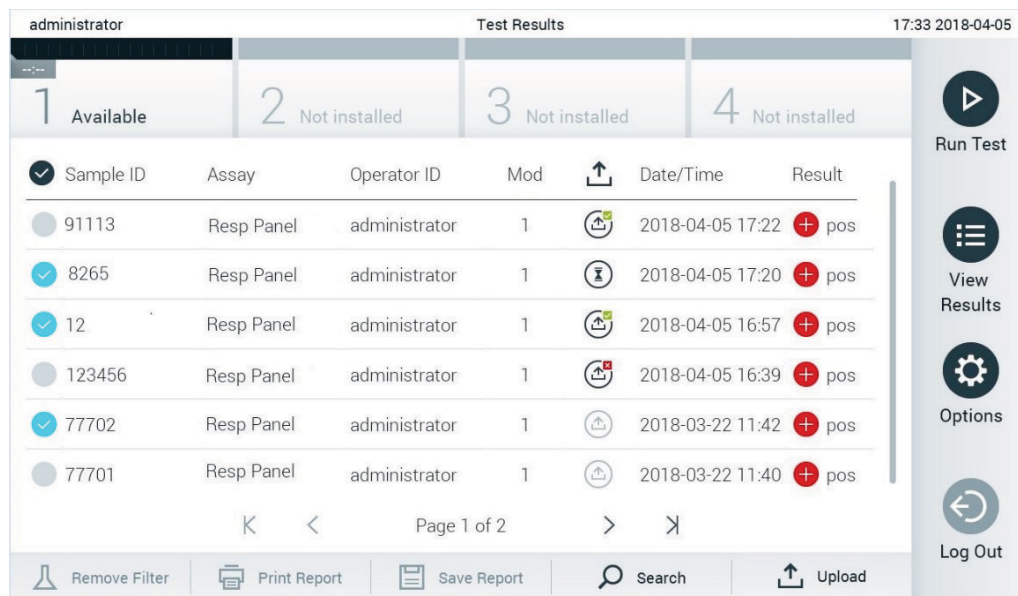

Figure 81. View Results screen.

7.5 Troubleshooting host connectivity

To troubleshoot host connectivity issues, see Section 9.1.

8 Maintenance

This section describes the maintenance tasks required for the QIAstat-Dx Analyzer 1.0.

8.1 Maintenance tasks

Table 15 provides a list of maintenance tasks to be performed on the QIAstat-Dx Analyzer 1.0.

Table 15. Descriptions of maintenance tasks

Task	Frequency
Cleaning or decontaminating the QIAstat-Dx Analyzer 1.0 surface	To be performed when liquids, chemicals, or biological specimens (potentially infectious) are spilled on the QIAstat-Dx Analyzer 1.0 surface
Exchange of air filter	To be performed annually

8.2 Cleaning the QIAstat-Dx Analyzer 1.0 surface

WARNING/ CAUTION 	Risk of personal injury and material damage Wear protective glasses, a lab coat and gloves when cleaning the instrument to avoid biological and chemical hazards.
--	---

WARNING/ CAUTION 	Risk of personal injury and material damage Disconnect the QIAstat-Dx Analyzer 1.0 from the power outlet before cleaning.
--	---

CAUTION 	Risk of damage to the QIAstat-Dx Analyzer 1.0 Avoid spilling chemicals or other liquids into or out of the QIAstat-Dx Analyzer 1.0. Damage caused by liquid spillage will void the warranty.
---	--

CAUTION 	Risk of damage to the QIAstat-Dx Analyzer 1.0 Avoid spilling liquids on or wetting the touchscreen. To clean the touchscreen, use the screen suede provided with the QIAstat-Dx Analyzer 1.0.
---	---

Use the following materials to clean the QIAstat-Dx Analyzer 1.0 surface:

- Mild detergent
- Paper towels
- Distilled water

Follow the steps below to clean the QIAstat-Dx Analyzer 1.0 surface:

1. Wear laboratory gloves, coat, and protective glasses.
2. Wet a paper towel in mild detergent and wipe down the QIAstat-Dx Analyzer 1.0 surface, as well as the surrounding workbench area. Take care not to wet the touchscreen. To clean the touchscreen, use the screen suede provided with the QIAstat-Dx Analyzer 1.0.
3. Repeat step 2 three times with fresh paper towels.
4. Wet a paper towel in distilled water and wipe down the QIAstat-Dx Analyzer 1.0 surface to rinse away remaining detergent. Repeat two times.
5. Dry the QIAstat-Dx Analyzer 1.0 surface with a fresh paper towel.

8.3 Decontaminating the QIAstat-Dx Analyzer 1.0 surface

<p>WARNING/ CAUTION</p> 	<p>Risk of personal injury and material damage</p> <p>Wear protective glasses, a lab coat and gloves when cleaning the instrument to avoid biological and chemical hazards.</p> <p>Bleach is irritating to eyes and skin and may release dangerous gases (chlorine). Wear adequate personal protection equipment.</p>
--	--

<p>WARNING/ CAUTION</p> 	<p>Risk of personal injury and material damage</p> <p>Disconnect the QIAstat-Dx Analyzer 1.0 from the power outlet before cleaning.</p>
--	--

<p>CAUTION</p> 	<p>Risk of damage to the QIAstat-Dx Analyzer 1.0</p> <p>Avoid spilling chemicals or other liquids into or out of the QIAstat-Dx Analyzer 1.0. Damage caused by liquid spillage will void the warranty.</p>
---	---

<p>CAUTION</p> 	<p>Risk of damage to the QIAstat-Dx Analyzer 1.0</p> <p>Avoid spilling liquids on or wetting the touchscreen. To clean the touchscreen, use the screen suede provided with the QIAstat-Dx Analyzer 1.0.</p>
---	--

Use the following materials to decontaminate the QIAstat-Dx Analyzer 1.0 surface:

- 10% bleach solution
- Paper towels
- Distilled water

Follow the steps below to decontaminate the QIAstat-Dx Analyzer 1.0 surface:

1. Wear laboratory gloves, coat, and protective glasses.
2. Wet a paper towel in the 10% bleach solution and wipe down the QIAstat-Dx Analyzer 1.0 surface, as well as the surrounding workbench area. Take care not to wet the touchscreen. Wait at least three minutes to allow the bleach solution to react with the contaminants.
3. Change into a new pair of gloves.
4. Repeat steps 2 and 3 two additional times with fresh paper towels.
5. Wet a paper towel in distilled water and wipe down the QIAstat-Dx Analyzer 1.0 surface to rinse away any remaining bleach solution. Repeat twice.
6. Dry the QIAstat-Dx Analyzer 1.0 surface with a fresh paper towel.

8.4 Replacing the air filter

The air filter must be exchanged every year to ensure the appropriate airflow rate inside the unit.

The air filter is located below the QIAstat-Dx Analyzer 1.0 and can be accessed by the user at the front of the instrument.

Air filters from QIAGEN must be used as replacement.

Follow these steps to exchange the air filter:

1. Set the QIAstat-Dx Analyzer 1.0 in standby mode by pressing the ON/OFF button on the front of the instrument.
2. Place a hand below the air filter drawer at the front of the QIAstat-Dx Analyzer 1.0 and use fingers to slightly push up.
3. Pull the air filter back until the filter drawer is completely removed. Dispose the old air filter.
4. Remove the new air filter drawer from its protective bag.
5. Insert the new air filter drawer into the QIAstat-Dx Analyzer 1.0. The unit is now ready for use.

CAUTION



Risk of damage to the QIAstat-Dx Analyzer 1.0

Only use original parts from QIAGEN. Use of non-authorized parts may result in damage to the unit and will void the warranty.

8.5 QIAstat-Dx Analyzer 1.0 repair

The QIAstat-Dx Analyzer 1.0 must only be repaired by representatives authorized by QIAGEN. If the QIAstat-Dx Analyzer 1.0 is not working as expected, contact QIAGEN Technical Services using the contact information in Section 9.

<p>WARNING/ CAUTION</p> 	<p>Risk of personal injury and material damage</p> <p>Do not open the QIAstat-Dx Analyzer 1.0 housing. Do not attempt to repair or modify the QIAstat-Dx Analyzer 1.0.</p> <p>Opening the housing or modifying the QIAstat-Dx Analyzer 1.0 inappropriately may result in user injury and QIAstat-Dx Analyzer 1.0 damage and will void the warranty.</p>
--	--

9 Troubleshooting

This section provides information on some issues that may occur with the QIAstat-Dx Analyzer 1.0, along with possible causes and solutions. The information is specific to the instrument. For troubleshooting relevant to a QIAstat-Dx assay cartridge, see the instructions for use for the respective cartridge.

If further assistance is required, contact QIAGEN Technical Services using the contact information below:

Website: support.qiagen.com

When contacting QIAGEN Technical Services about an error with the QIAstat-Dx Analyzer 1.0, note the steps leading up to the error and any information appearing in any dialog boxes. This information will help the QIAGEN Technical Services solve the problem.

When contacting QIAGEN Technical Services about errors, please have the following information ready:

- QIAstat-Dx Analyzer 1.0 serial number, type, software version, and installed **Assay Definition Files**
- Error code (if applicable)
- Timepoint when the error occurred for the first time
- Frequency of error occurrence (i.e., intermittent or persistent error)
- Photo of error, if possible
- Support Package

9.1 Hardware and software errors

Error	Possible cause	Comments and suggestions
The QIAstat-Dx Analyzer 1.0 does not start.	The QIAstat-Dx Analyzer 1.0 is not connected to the power outlet. The power switch at the back of the QIAstat-Dx Analyzer 1.0 is not powered ON. The QIAstat-Dx Analyzer 1.0 is in standby mode.	Check that the QIAstat-Dx Analyzer 1.0 is connected to the main power. Power ON using the power switch at the back of QIAstat-Dx Analyzer 1.0. Press the ON/OFF button to take the QIAstat-Dx Analyzer 1.0 out of standby mode.
Analytical Module not detected.	Analytical/Operational Module bridge is not properly connected.	Check that the bridge between the Operational Module and the Analytical Module is properly connected.
The Analytical Module status indicator is red.	Hardware failure.	Contact QIAGEN Technical Services.

Error	Possible cause	Comments and suggestions
The touchscreen does not respond.	The QIAstat-Dx Analyzer 1.0 is in standby mode (status indicator is blue). Hardware failure.	Press the ON/OFF button on the Operational Module. Contact QIAGEN Technical Services.
Bar code reader does not scan.	Sample ID bar code feature is not enabled. Bar code reader has a hardware or software problem.	Contact a Laboratory Supervisor or instrument Administrator to configure the bar code feature on the QIAstat-Dx Analyzer 1.0. Contact QIAGEN Technical Services.
The QIAstat-Dx assay cartridge is stuck inside the QIAstat-Dx Analyzer 1.0.	Module mechanical failure.	Contact QIAGEN Technical Services.
Lid of the cartridge entrance port does not open.	Module mechanical failure.	Contact QIAGEN Technical Services.
The Run Test button is not active.	A QIAstat-Dx assay cartridge is still inside the QIAstat-Dx Analyzer 1.0 and must be ejected before the QIAstat-Dx Analyzer 1.0 will allow a new test execution. The module is not available.	The status box of the module in the Module status bar should show the text "Eject cartridge". Press the status box of the module and then press the Eject . Check that the bridge between the Operational Module and the Analytical module is properly connected.
Assay does not run.	The user does not have rights to run the test. The assay is not installed on the QIAstat-Dx Analyzer 1.0.	Contact a Laboratory Supervisor or instrument Administrator. The assay needs to be installed. Contact a Laboratory Supervisor or instrument Administrator.
Result upload status is "Error".	Connectivity with the host has been lost. Communication with the host has timed out. Message rejected from host.	Contact a Laboratory Supervisor or instrument Administrator to check connection details and test connectivity. Contact a Laboratory Supervisor or instrument Administrator to check the Timeout settings value, which can be increased to a maximum value of 60 seconds. If it is already set to the maximum value, then network performance should be reviewed. The host rejected the message for some reason (assay not recognized, semantic issues, etc.). Contact QIAGEN Technical Services.
A result cannot be uploaded.	Result status is expired.	Contact a Laboratory Supervisor or instrument Administrator to check the Expire Time in the HIS/LIS settings.
Cannot run a test because there is no test order.	There is no test order for the sample ID and Force Order is enabled in the HIS/LIS settings. Connectivity issue with the LIS and Force Order is enabled in the HIS/LIS settings.	Contact a LIS administrator to check if there is an order for the specified sample ID in the LIS. Contact a Laboratory Supervisor or instrument Administrator to check connectivity with the host. To run the assay without a test order, disable Force Order in the HIS/LIS settings.
Printer is not setup correctly, or test reports cannot be printed.	There are different causes of printer malfunction.	Visit QIAGEN.com/QIAstat-Dx_PrinterSetup for frequently asked questions on troubleshooting for printer setup and guidance to avoid common printer issues.
System Update and System Backup buttons are not active.	The HIS/LIS connection is disrupted.	When an upload to the HIS/LIS was disrupted (e.g. because the HIS/LIS was turned off), the system tries to upload the data regardless. During an upload, the system update and system backup is disabled. To enable it again, disable the HIS/LIS connection and empty the upload queue.
Time zone change is not applied.	The selected time zone is not recognized by the device.	Select a different time zone with the same offset.

9.2 Errors and warning messages

Error/Warning	Explanation	Comments and suggestions
The AM in the slots has changed.	The system detects that the hardware configuration has changed. At least one of the Analytical Modules has been changed to another location.	Nothing needs to be done. The system is self-configurable after a module's location changes.
Performing a backup is recommended before updating or restoring.	Data may be lost during the update process if an error occurs. A backup allows for system and data recovery.	It is highly recommended to make a backup of the system before a system restoration or update.
Shutdown not possible. Please stop all tests and eject cartridges.	When a test is running, the QIAstat-Dx Analyzer 1.0 cannot be shut down.	Wait until test completion, or cancel the test, and then shut down the system.
Free disc space <i>ddd</i> reached warning or critical level.	System needs to be reviewed by QIAGEN Technical Services to add additional disk space.	Contact QIAGEN Technical Services.
The system was not shut down properly last time.	The system was not shut down following the procedure. The last test data could have been lost.	The QIAstat-Dx Analyzer should be properly shut down by pressing the ON/OFF button on the front of the instrument before powering OFF the instrument using the power switch on the back of the instrument, or disconnecting from the power outlet, as explained in Section 6.11.
Test result with invalid data found.	An unexpected error during last test was found.	Try to re-run the test with a new QIAstat-Dx assay cartridge. If the problem persists or occurs frequently, contact QIAGEN Technical Services.
Unexpected behavior of AM <i>nnn</i> .	General system failure.	Restart the system. If the problem persists, contact QIAGEN Technical Services.
Update data aborted, error occurred.	Unexpected error occurred while updating the QIAstat-Dx Analyzer 1.0.	Contact QIAGEN Technical Services.
No backup file found!	A proper backup .dbk file was not found on the USB storage device.	Check if the file exists on the USB storage device. If the problem persists, contact QIAGEN Technical Services.
Assay <assay_id> not available. Code: 0x400	The assay corresponding to the QIAstat-Dx assay cartridge has not been imported to the QIAstat-Dx Analyzer 1.0.	Import the assay to the QIAstat-Dx Analyzer 1.0 (see Section 6.7.3).
Assay <assay_name> not active.	The assay is not active.	Activate the assay (see Section 6.7.1).
Assay <assay_name> already imported. Code: 0x0304	There is an assay with the same ID and version available in the database.	The assay is already loaded in the system. Nothing needs to be done.
Import assay failed; the assay file is invalid.	The assay file to be imported is not correct.	Download the assay file again from www.qiagen.com . Contact QIAGEN Technical Services if the issue persists.
Importing ADF <adf_name> failed. Code: 0x0305	The assay file to be imported is not correct.	Download the assay file again from www.qiagen.com . Contact QIAGEN Technical Services if the issue persists.
Login failed!	The login operation failed.	Contact a Laboratory Supervisor or instrument Administrator.
Login failed! The user is not activated.	User does not have permission to use the QIAstat-Dx Analyzer 1.0.	Contact a Laboratory Supervisor or instrument Administrator to activate the user (see Section 6.6.1).

Error/Warning	Explanation	Comments and suggestions
Login failed! Wrong Password!	The entered password is incorrect.	After three failed attempts to enter the password, the user must wait one minute before trying to log in again. If the password has been forgotten, contact the instrument Administrator to set a new one.
Login failed! User identification does not exist.	User has not been added to the system.	Contact the instrument Administrator or Laboratory Supervisor to add the new user.
Passwords are not identical!	To set up a new password, it must be entered identically two times.	Enter two identical passwords.
Invalid Password! Min. length 6 characters. Max. length 15 characters. Allowed characters: 0-9, a-z, A-Z, _, space.	Password does not comply with security policies.	Set a password with a minimum length of 6 characters and maximum length of 15 characters, containing only the allowed characters: 0-9, a-z, A-Z, _, space.
Export failed!	An unexpected error occurred during the results export operation.	Retry the operation. If the problem persists, contact QIAGEN Technical Services.
USB Device not found.	USB storage device is not detected in the QIAstat-Dx Analyzer 1.0. USB storage device is encrypted or is not formatted in FAT32 format.	Insert a USB storage device in the USB port.
Bar code reading failed.	Bar code reader malfunction.	Contact QIAGEN Technical Services.
Failed to scan bar code.	There is no assay loaded in the system for this bar code.	The bar code may be damaged. Use a different QIAstat-Dx assay cartridge. If the problem persists, contact QIAGEN Technical Services.
Test failed, Error: <error_code>.	Test failed with an error.	Retry executing the test with a new QIAstat-Dx assay cartridge. If the problem persists, contact QIAGEN Technical Services and provide the error code message.
User has no right to execute assay <assay_name>. Code: 0x0402	The user does not have permission to execute the assay.	Permission can be granted from the User Management screen (refer to Section 6.6).
Cartridge already used.	A previously used QIAstat-Dx assay cartridge cannot be re-used.	Dispose of the used QIAstat-Dx assay cartridge according to relevant safety and disposal regulations. Run the test using a new QIAstat-Dx assay cartridge.
Cartridge expired.	The QIAstat-Dx assay cartridge cannot be used because its expiration date has lapsed.	The QIAstat-Dx assay cartridge can no longer be used. Dispose of the cartridge according to relevant safety and disposal regulations.
Different cartridge inserted.	The QIAstat-Dx assay cartridge inserted does not match the cartridge detected by the bar code reader.	Insert the same QIAstat-Dx assay cartridge that was scanned with the bar code reader.
Failed to create file.	The backup file could not be created.	The USB storage device is not working. Retry using a different USB storage device.
HIS/LIS timeout.	Communication between the instrument and LIS has timed out.	Check the Timeout value in the HIS/LIS settings and increase the value. If the maximum value is already set, contact QIAGEN Technical Services.
Results in state "Uploading" or "Expired" cannot be uploaded.	A result upload expired cannot be uploaded anymore. While a result is in upload status "Uploading", it cannot be uploaded.	Expiration time can be changed in HIS/LIS settings. After status "Uploading" is complete, a result can be uploaded again.
The maximum number of results for upload <num> is exceed <num>.	The maximum number of results for simultaneous upload has been reached.	Deselect some results and attempt again.

Error/Warning	Explanation	Comments and suggestions
No book order for this sample ID. Do you want to continue anyway?	LIS did not return a test order for a sample ID. Force Order is set to "disabled" in Order Settings .	Continuing the test means that the corresponding result will not have a matching order in the LIS after uploading the result.
Order not found.	LIS did not return a test order for a sample ID. Force Order is set to "enabled" in Order Settings .	It is not possible to run the test. The reason for this message could be due to the following reasons: the LIS did not send an order for the sample ID, timeout was reached or there is a connection problem with the host.
Ordered assay not installed.	The assay requested in the test order is not installed on the QIAstat-Dx Analyzer 1.0. The assay name in the QIAstat-Dx Analyzer 1.0 does not match the assay name sent by the LIS.	Install the appropriate assay. Check the LIS assay name in the HIS/LIS settings.
No connection to HIS/LIS.	There is no connectivity between the LIS and the QIAstat-Dx Analyzer 1.0.	Check connectivity details in the HIS/LIS settings.

10 Technical Specifications

Operating conditions

Power requirements	100-240 VAC 50–60 Hz IEC 60320-1 C14 socket
Power consumption	300 VA per AM
Fuse	1x8A time-lag
Temperature	15–30°C (59–86°F)
Humidity	20–80% relative, non-condensing
Altitude	0–2200 m
Light	Up to 4000 lux

Shipping conditions

Temperature	0–55°C (32–131°F), maximum 85% relative humidity, non-condensing
-------------	--

Electromagnetic compatibility (EMC)

EMC requirements	Compliant with IEC 61326 Class A The equipment has been designed and tested to CISPR 11 Class A. In a domestic environment it may cause radio interference, in which case, you may need to take measures to mitigate the interference.
------------------	---

Mechanical data and hardware features

Operational Module

Dimensions	Width: 234 mm
	Height: 326 mm
	Depth: 517 mm
Weight	5 kg

Analytical Module

Dimensions	Width: 153 mm
	Height: 307 mm
	Depth: 428 mm
Weight	16 kg

Ethernet Interface	1x 10/100 – Base-T Ethernet
USB ports	1 front and 3 rears

11 Appendices

11.1 Printer installation and configuration

Additional guidance on frequently asked questions on troubleshooting for printer setup and guidance to avoid common printer issues can be found on [QIAGEN.com/QIAstat-Dx_PrinterSetup](https://www.qiagen.com/QIAstat-Dx_PrinterSetup).

11.1.1 Printer installation via USB

Follow the steps below to install a printer using a USB connection:

1. Connect the USB cable from the printer to one of the USB port of the Operational Module.
There are 4 available USB ports: 1 on the right side of the screen, and 3 at the back of the instrument.
2. Enable the printer under the **Printer** settings by selecting the available option **PRINTER** or install the specific CUPS driver described in Appendix 11.1.3.

Note: When printing via the pre-installed printer does not work, it is recommended to connect a local computer to the QIAstat-Dx Analyzer and follow the instructions for printer installation via Ethernet (refer to Section 11.1.2).

Note: When printing via a USB connected printer does not work, print job status and other information can be found via CUPS interface. To access this, it is recommended to connect a local computer to the QIAstat-Dx Analyzer and follow the instructions for printer installation via Ethernet (refer to Section 11.1.2).

11.1.2 Printer installation via Ethernet

Note: For printer installation via Ethernet, it is required to have a network printer, a local computer, and QIAstat-Dx Analyzer available and located in the same local network.

Follow the steps below to install a networked printer using an Ethernet connection:

3. Connect the printer to an Ethernet network and power ON the printer.
4. Enable network settings of QIAstat-Dx Analyzer (refer to Section 6.8.6).
5. Ensure that network configuration of the local computer is correct.
6. Install the CUPS driver via web described in Appendix 11.1.3.
7. Restart the QIAstat-Dx Analyzer 1.0 by powering it OFF and then ON.
8. Enable the printer using the **Printer** settings by selecting the new available option (the installed printer) and press **Save**.

11.1.3 CUPS printer driver installation

CUPS (Common UNIX Printing System) is a printing system for Unix-like computer operating systems which allows the QIAstat-Dx Analyzer 1.0 Operational Module to act as a print server. CUPS uses PPD (PostScript® Printer Description) drivers for all its PostScript printers and non-PostScript printing devices. The QIAstat-Dx Analyzer 1.0 Operational Module has pre-installed PPD drivers, but custom drivers can also be uploaded.

Note: QIAGEN cannot guarantee that any printer will work with the QIAstat-Dx Analyzer 1.0. For a list of tested printers, see Appendix 11.1.4.

To install a new printer driver, perform the following steps:

1. Activate CUPS in the QIAstat-Dx Analyzer 1.0 Operational Module application software under **Options** -> **System Config** -> **Network** -> **Enable CUPS** and then press **Save** to save the settings (this procedure must be performed with Administrator privileges).

2. On a computer in the same local network, log in to CUPS via web browser (example: <http://10.7.101.38:631/admin>).

Note: The IP-address, which must be used, can be found under **Options** -> **System Config** -> **Network** -> **MAC/IP address**".

Use the following information to log in:

User name: cups-admin

Password: use the password that is provided in the QIAstat-Dx Analyzer 1.0 Operational Module application software under **Options** -> **System Config** -> **Network** -> **CUPS settings**.

3. Click Add printer.

4. Select a printer from the list of printers available on the network and press **Continue**.

5. Select **Share this printer** and press **Continue** (Figure 82, next page).

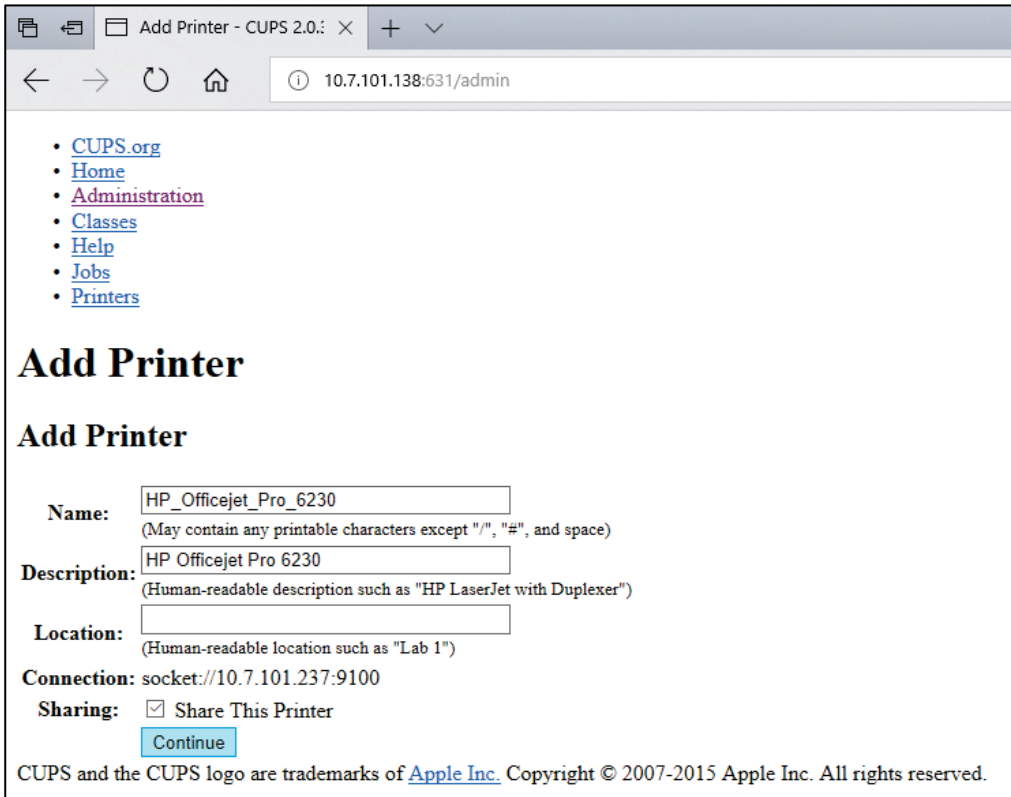

Figure 82. Add printer screen.

6. Select the printer driver for your printer and press **Add Printer**.

Note: If your printer driver is not listed, use the most generic driver for your printer brand. If none of the listed drivers are working, download the necessary CUPS driver as a PPD file from the web and select it in the **Or Provide a PPD File** field before you press **Add Printer** (Figure 83, next page).

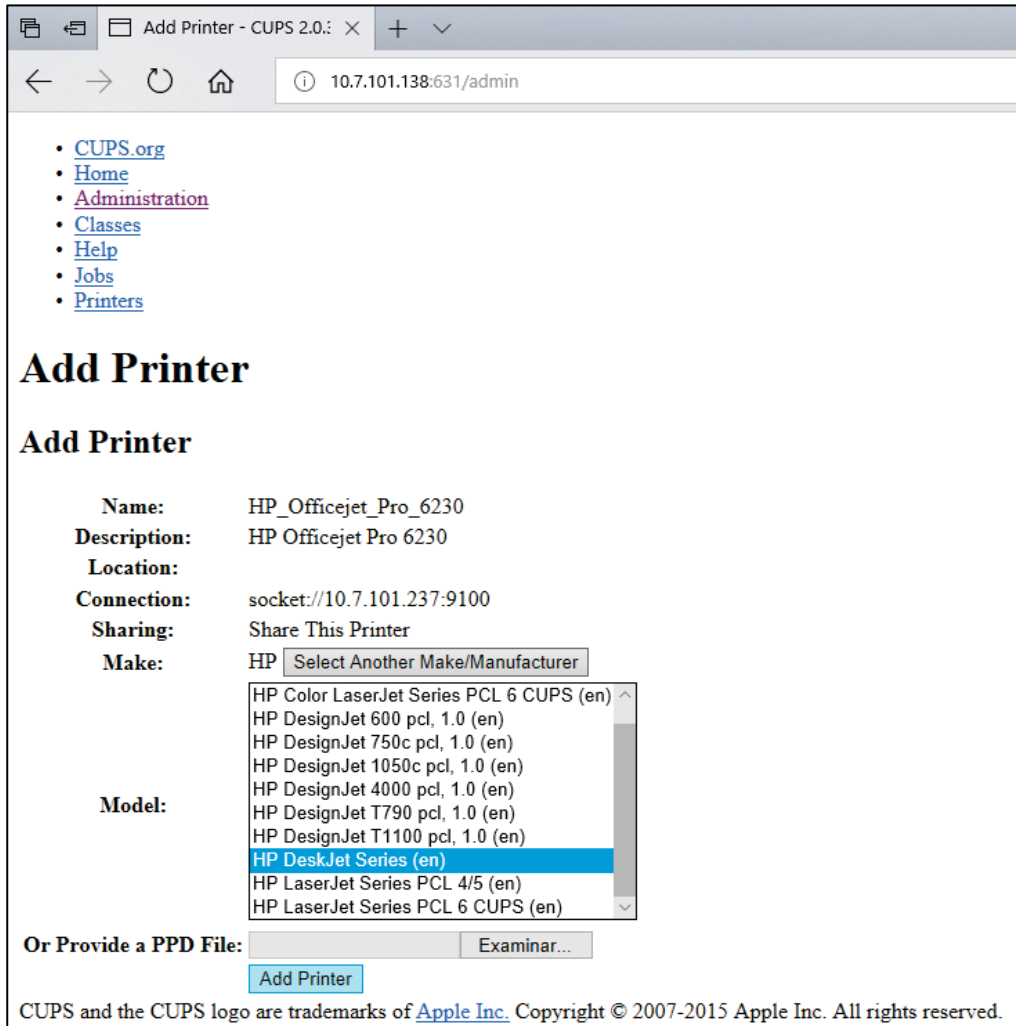

Figure 83. Selecting the printer driver.

7. Select the correct **Media Size** (such as "A4"), because some printers will not print if the paper format is incorrect. Next, save the selection by pressing **Set Default Options** (Figure 84, next page).

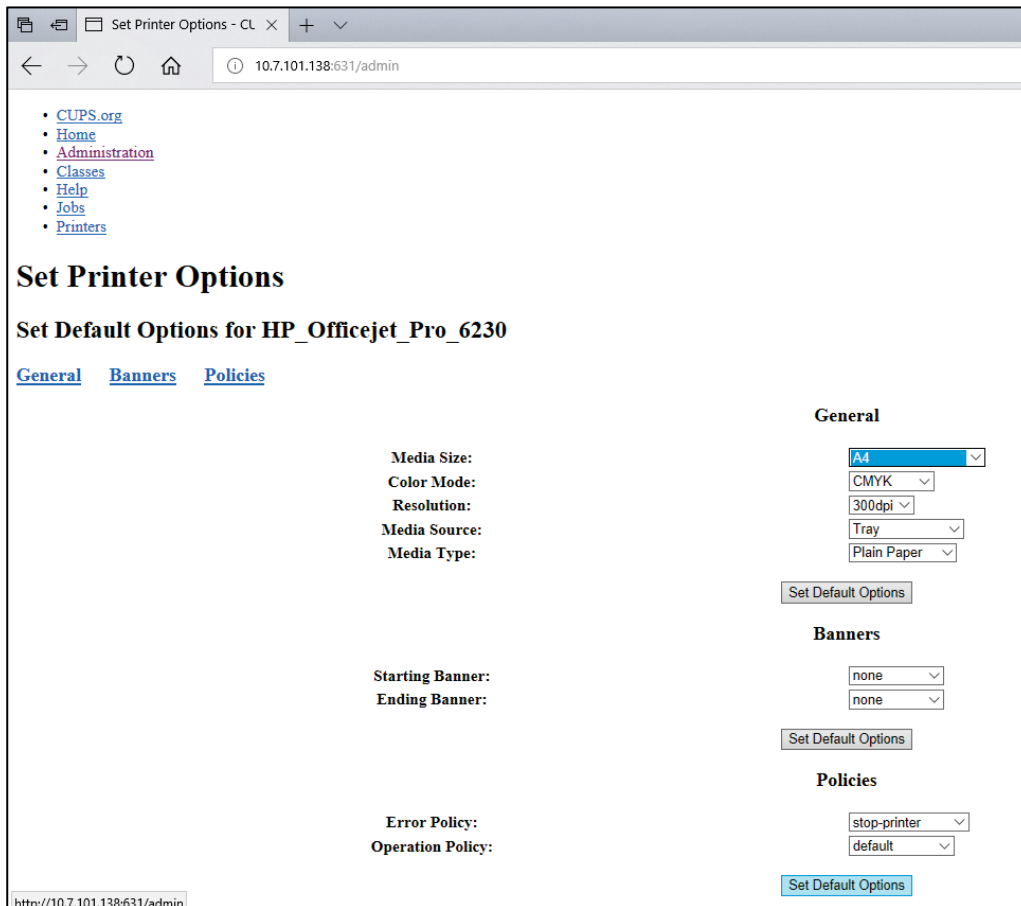

Figure 84. Selecting correct Media Size.

8. Power OFF the QIAstat-Dx Analyzer 1.0 Operational Module using the rear switch and then power ON again to make the driver available.
9. Enable the installed printer under **Options** -> **System Config** -> **Printer**. Select the desired printer and press **Save**. The printer now is ready for use.

11.1.4 List of tested printers

At the time this User Manual is released, the following printers have been tested by QIAGEN and are compatible with the QIAstat-Dx Analyzer 1.0, through both USB and Ethernet connections:

- HP® OfficeJet® Pro 6230
- HP Color LaserJet® Pro M254dw
- Brother® MFC-9330CDW

For the most recent list of tested printers, visit QIAGEN.com/QIAStat-Dx_PrinterSetup.

Other printers may be compatible with the QIAstat-Dx Analyzer 1.0 through the procedure outlined in Appendix 11.1.3.

11.2 Declaration of Conformity

Name and address of the legal manufacturer:

QIAGEN GmbH

QIAGEN Strasse 1, D-40724 Hilden, Germany

An up-to-date Declaration of Conformity can be requested from QIAGEN Technical Services.

11.3 Waste Electrical and Electronic Equipment (WEEE)

This section provides information about disposal of waste electrical and electronic equipment by users.

The crossed-out wheeled bin symbol (see below) indicates that this product must not be disposed of with other waste; it must be taken to an approved treatment facility or to a designated collection point for recycling, according to local laws and regulations.

The separate collection and recycling of waste electronic equipment at the time of disposal helps to conserve natural resources and ensures that the product is recycled in a manner that protects human health and the environment.



Recycling can be provided by QIAGEN upon request at additional cost. In the European Union, in accordance with the specific WEEE recycling requirements and where a replacement product is being supplied by QIAGEN, free recycling of its WEEE-marked electronic equipment is provided.

To recycle electronic equipment, contact your local QIAGEN sales office for the required return form. Once the form is submitted, you will be contacted by QIAGEN either to request follow-up information for scheduling collection of the electronic waste or to provide you with an individual quote.

11.4 Liability clause

QIAGEN shall be released from all obligations under its warranty in the event repairs or modifications are made by persons other than its own personnel, except in cases where QIAGEN has given its written consent to perform such repairs or modifications.

All materials replaced under this warranty will be warranted only for the duration of the original warranty period, and in no case beyond the original expiration date of original warranty unless authorized in writing by an officer of QIAGEN. Read-out devices, interfacing devices, and associated software will be warranted only for the period offered by the original manufacturer of these products. Representations and warranties made by any person, including representatives of QIAGEN, which are inconsistent or in conflict with the conditions in this warranty shall not be binding upon QIAGEN unless produced in writing and approved by an officer of QIAGEN.

11.5 Software License Agreement

TERMS AND CONDITIONS of a LEGAL AGREEMENT (the "**Agreement**") by and between QIAGEN GmbH, QIAGEN Strasse 1, D-40724 Hilden, Germany, ("**QIAGEN**") and you (either an individual or a legal entity), the licensee of the software (hereinafter referred to as "**SOFTWARE**")

By installing, having installed and using the SOFTWARE you are agreeing to be bound by the terms of this Agreement. If you do not agree to the terms of this Agreement, promptly return the software package(s) and the accompanying items (including written materials) to the place you obtained them for a full refund of the costs of the SOFTWARE.

1. GRANT OF LICENSE

Scope. Subject to the terms and conditions of this agreement, QIAGEN grants you a worldwide, perpetual, non-exclusive, and nontransferable license to use the SOFTWARE solely for your internal business purposes.

You shall not:

- modify or alter the whole or any part of the SOFTWARE nor merge any part of it with another software nor separate any components of the SOFTWARE from the SOFTWARE nor, save to the extent and in the circumstances permitted by law, create derivative works from, or, reverse engineer, decompile, disassemble or otherwise derive source code from the SOFTWARE or attempt to do any of these things
- copy the SOFTWARE (except as provided above)
- assign rent, transfer, sell, disclose, deal in, make available or grant any rights in the Software Product in any form to any person without the prior written consent of QIAGEN;
- remove alter, obscure, interfere with or add to any proprietary notices, labels, trademarks, names, or marks on, annexed to, or contained within the SOFTWARE;
- use the SOFTWARE in any manner that infringes the intellectual property or other rights of QIAGEN or any other party; or
- use the SOFTWARE to provide on-line or other database services to any other person.

Single-Computer Use. This Agreement permits you to use one copy of the SOFTWARE on a single computer.

Trial versions. Trial versions of the SOFTWARE may expire after a period of 30 (thirty) days without prior notice.

Open Software/Third Party Software. This Agreement does not apply to any other software components identified as subject to an open source license in the relevant notice, license and/or copyright files included with the programs (collectively the "**Open Software**"). Furthermore, this Agreement does not apply to any other software for which QIAGEN is only granted a derived right to use ("**Third Party Software**"). Open Software and Third Party Software may be supplied in the same electronic file transmission as the SOFTWARE, but are separate and distinct programs. The SOFTWARE is not subject to the GPL or any other open source license.

If and insofar QIAGEN provides Third Party Software, the license terms for such Third Party Software shall additionally apply and prevail. If Open Software is provided, the license terms for such Open Software shall additionally apply and prevail. QIAGEN shall provide you with the corresponding source code of relevant Open Software, if the respective license terms of the Open Software include such obligation. QIAGEN shall inform if the SOFTWARE contains Third Party Software and/or Open Software and make available the corresponding license terms on request.

2. UPGRADES

If the SOFTWARE is an upgrade from a previous version, you are granted a single license to both copies, and you may not separately transfer the prior version(s) except as a one-time permanent transfer to another user of the latest upgrade and all prior versions as allowed in Section 4 below.

3. COPYRIGHT

The SOFTWARE, including any images, and text incorporated in the SOFTWARE, is copyrighted and is protected by German copyright laws and international treaty provisions. You may not copy any of the printed materials accompanying the SOFTWARE.

4. OTHER RESTRICTIONS

You may not rent or lease the SOFTWARE, but you may transfer the SOFTWARE and accompanying written materials on a permanent basis to another end user provided you delete the setup files from your computer, and the recipient agrees to the terms of this Agreement. You may not reverse engineer, decompile, or disassemble the SOFTWARE. Any transfer of the SOFTWARE must include the most recent upgrade and all prior versions.

Note: For additional license agreements of third party software included in the QIAstat-Dx Analyzer navigate to "Options" > "**System Config**" > "**Version Info**".

5. LIMITED WARRANTY

QIAGEN warrants that (a) the SOFTWARE will perform substantially in accordance with the accompanying printed materials for a period of ninety (90) days from the date of receipt. Any implied warranties on the SOFTWARE are limited to ninety (90) days. Some states/jurisdictions do not allow limitations on duration of an implied warranty, so the above limitation may not apply to you.

6. CUSTOMER REMEDIES

QIAGEN entire liability and your exclusive remedy shall be, at QIAGEN's option, either (a) return of the price paid or (b) repair or replacement of the SOFTWARE that does not meet QIAGEN's Limited Warranty and that is returned to QIAGEN with a copy of your receipt. This Limited Warranty is void if failure of SOFTWARE has resulted from accident, abuse, or misapplication. Any replacement of SOFTWARE will be warranted for the remainder of the original warranty period or thirty (30) days, whichever is longer.

7. LIMITED LIABILITY

In no event shall QIAGEN or its suppliers be liable for any damages whatsoever (including, without limitation, damages for loss of business profits, business interruption, loss of business information, or other pecuniary loss, unforeseeable damage, lack of commercial success, indirect damage or consequential damage – in particular financial damage – or for damage resulting from third party claims) arising out of the use or inability to use the SOFTWARE, even if QIAGEN has been advised of the possibility of such damages.

The above restrictions of liability shall not apply in cases of personal injury or any damage resulting from willful acts or gross negligence or for any liability based on the Product Liability Act (Produkthaftungsgesetz), guarantees or other mandatory provisions of law.

The above limitation shall apply accordingly in case of:

- delay,
- compensation due to defect,
- compensation for wasted expenses.

8. NO SUPPORT

Nothing in this agreement shall obligate QIAGEN to provide any support for the SOFTWARE. QIAGEN may, but shall be under no obligation to, correct any defects in the SOFTWARE and/or provide updates to licensees of the SOFTWARE. You shall make reasonable efforts to promptly report to QIAGEN any defects you find in the SOFTWARE, as an aid to creating improved revisions of the SOFTWARE.

Any provision of support by QIAGEN for the SOFTWARE (including network installation support), if any, shall solely be governed by an according separate support agreement.

9. TERMINATION

If you fail to comply with the terms and conditions of this Agreement, QIAGEN may terminate this Agreement and your right and license to use the SOFTWARE. You may terminate this Agreement at any time by notifying QIAGEN. Upon the termination of this Agreement, you must delete the SOFTWARE from your computer(s) and archives.

YOU AGREE THAT UPON TERMINATION OF THIS AGREEMENT FOR ANY REASON, QIAGEN MAY TAKE ACTIONS SO THAT THE SOFTWARE NO LONGER OPERATES.

10. GOVERNING LAW, VENUE

This Agreement shall be construed and interpreted in accordance with the laws of Germany, without giving effect to conflict of laws' provisions. The application of the provisions of the UN Sales Convention is excluded. Notwithstanding any other provision under this Agreement, the parties to this Agreement submit to the exclusive jurisdiction of the Düsseldorf courts.

11.6 Disclaimer of warranties

EXCEPT AS PROVIDED IN QIAGEN TERMS AND CONDITIONS OF SALE FOR THE QIAstat-Dx Analyzer 1.0, QIAGEN ASSUMES NO LIABILITY WHATSOEVER AND DISCLAIMS ANY EXPRESS OR IMPLIED WARRANTY RELATING TO THE USE OF THE QIAstat-Dx Analyzer 1.0 INCLUDING LIABILITY OR WARRANTIES RELATING TO MERCHANTABILITY, FITNESS FOR A PARTICULAR PURPOSE, OR INFRINGEMENT OF ANY PATENT, COPYRIGHT, OR OTHER INTELLECTUAL PROPERTY RIGHT ANYWHERE IN THE WORLD.

The QIAstat-Dx Analyzer 1.0 is equipped with an Ethernet port. The Purchaser of the QIAstat-Dx Analyzer 1.0 is solely responsible for preventing any and all computer viruses, worms, trojans, malware, hacks, or any other type of cybersecurity breaches. QIAGEN assumes no liability for computer viruses, worms, trojans, malware, hacks, or any other type of cybersecurity breaches.

11.7 Glossary

Analytical Module (AM): The main QIAstat-Dx Analyzer 1.0 hardware module, in charge of executing tests on QIAstat-Dx assay cartridges. It is controlled by the Operational Module (OM).

Assay Definition File: An Assay Definition File is a file necessary for executing an assay on a QIAstat-Dx Analyzer 1.0. The content of the file describes what can be measured, how to measure it and how to evaluate the raw measurement results. The file should be imported to the QIAstat-Dx Analyzer 1.0 before executing an assay the first time.

GUI: Graphical user interface.

IFU: Instructions for use.

Operational Module (OM): The dedicated QIAstat-Dx Analyzer 1.0 hardware that provides the user interface for 1–4 Analytical Modules (AM).

User: A person who operates the QIAstat-Dx Analyzer 1.0 in the intended way.

INDEX

About this user manual	6	assay name configuration	87
Accessing and managing the list of users	63	configuration of QIAstat-Dx Analyzer 1.0	
Add printer screen	106	for uploading a test result automatically	
Adding users	66	to the host	91
Appendices	104	configuration of QIAstat-Dx Analyzer 1.0	
Archive file creation with remove function	60	for uploading a test result manually to	
Archive file creation without removal		the host	92
function	60	configuration of the QIAstat-Dx Analyzer	
Archive results	59	1.0 with host connectivity	88
Assay management	68	creating a test order with host connectivity	
managing available assays	68	results Summary screen	91
Assay statistics	66	running a test based on a test order	88
Assign user profiles	64	troubleshooting host connectivity	93
Automatic log-off	76	upload the test result automatically to the	
Canceling a test run	41	host	91
Change passwords	83	uploading a test result manually to the	
Configuring the QIAstat-Dx Analyzer	71	host	93
Controls		uploading a test result to the host	91
failed controls	46	HIS/LIS settings	74
passed controls	46	Host Communication	86
Create archive	60	Host Settings	86
Creating an epidemiology report	69	Importing new assays	70
CUPS printer driver installation	105	Installation Procedures	20
Data security	15	Installing additional Analytical Modules	27
Declaration of Conformity	109	Intended use	8
Disclaimer of warranties	116	Introduction	6
Errors and warning messages	100	Liability clause	111
General Description	16	Limitations of use	8
General information	7	List of tested printers	108
General settings	76	Login screen	56
automatic log-off	76	logging out	58
Exclude Modules	76	Main screen	52
Patient ID Mandatory	76	Content area	55
Prefer Patient ID Bar Code	76	General status bar	53
Prefer Sample ID Bar Code	76	Main Menu bar	55
require password	76	Module status bar	53
Restore Factory Default	76	Maintenance	94
Sample ID Mandatory	76	cleaning the QIAstat-Dx Analyzer 1.0	
Use Patient ID	76	surface	94
User Access Control	76	decontaminating the QIAstat-Dx Analyzer	
Glossary	117	1.0 surface	95
HIS/LIS Connectivity	86	QIAstat-Dx Analyzer 1.0 repair	97
activating and configuring communication		replacing the air filter	96
with the HIS/LIS	86		

Managing available assays	68	display during test order retrieval.	89
importing new assays	70	scanning sample ID bar code	88
Module states that may be displayed in		scanning the QIAstat-Dx assay cartridge	
status boxes	54	bar code.	90
Module status page	54	selecting sample type	90
Network settings	77, 78	Safety	9
Network Share	79	Safety information	
Network share settings	80	biological safety	12
Note	9	chemical safety	11
Open archive	61	electrical safety	11
Options menu	59	proper use	10
Order Settings	87	symbols	14, 15
Passwords	83	transport precautions	11
Policy statement	7	waste disposal	13
Preparing the QIAstat-Dx cartridge	34	Saving reports	43, 50, 60, 61, 62, 83
Printer installation via Ethernet	104	Scanning the QIAstat-Dx assay cartridge	
Printer installation via USB	104	bar code.	36
Printer settings	77	Screen saver	58
Printing report	50	Searching results	49
Printing reports	49	Selecting correct Media Size	108
Procedure to run a test	35	Selecting the printer driver	107
QIASphere Base settings	74	Shutting down the QIAstat-Dx Analyzer 1.0	
QIAstat-Dx Analyzer 1.0 delivery and		components	85
components	21	Site requirements	20
QIAstat-Dx Analyzer 1.0 description	16	Software License Agreement	112
QIAstat-Dx Analyzer 1.0 repair	97	Starting the QIAstat-Dx Analyzer 1.0	34
QIAstat-Dx Analyzer 1.0 system status	85	System configuration	
QIAstat-Dx Analyzer software	19	general settings	76
QIAstat-Dx cartridge description	18	HIS/LIS settings	74
Regional settings	71	network settings	77
date	72	printer installation via Ethernet	104
language	72	printer installation via USB	104
time	72	printer settings	77
Repackaging and shipping the QIAstat-Dx		regional settings	71
Analyzer 1.0	32	system backup	82
Result Upload	86	system log	80
Results Upload Settings	87	system update	81
Running a test		version information	81
canceling a test run	41	System description	16
confirm screen	37	System Features	
ejecting QIAstat-Dx cartridge	39	assay management	68
inserting QIAstat-Dx cartridge	38	change password	83
run time display	39	configuring the QIAstat-Dx Analyzer	71
scanning QIAstat-Dx cartridge bar code		Login screen	56
	35	Main screen	52
scanning sample ID bar code	35	Options menu	59
selecting sample type	36	QIAstat-Dx Analyzer 1.0 system status	85
viewing results	42	screen saver	58
Running a Test and Viewing Results	34	shutting down	85
Running a test based on a test order		user management	62

System Functions and Options	52	adding users	66
System log	80	assay statistics	66
Technical assistance	7	assign user profiles	64
Technical Specifications	103	user profiles	62
electromagnetic compatibility	103	Viewing results	42
mechanical data and hardware features	103	amplification curves	43
operating conditions	103	CONTROLS tab	44
shipping conditions	103	exporting to USB drive	50
Test Orders	87	linear scale	45
Troubleshooting	98	logarithmic scale	45
errors and warning messages	100	melting curves	45
hardware errors	98	PATHOGENS tab	44, 45
software errors	98	possible outcomes	49
Unpacking and installing the QIAstat-Dx		previous tests	47
Analyzer 1.0	23	printing results	50
User Access Control	76	searching results	49
User management	62	test details	46
Accessing and managing the list of users	63	WARNING	9
		Waste disposal	110

Document Revision History

Date	Changes
Revision 1 HB-2636-001 04/2019	Initial release. For use with software version 1.2.x or higher.
Revision 2 HB-2636-002 06/2020	Added sections on data security and the use of the USB storage device; the QIAstat-Dx Analyzer software; initial configuration of the software; creating a support package; archiving results; system updates; debug logging; and printer installation and configuration. <i>Added reference to the QIAstat-Dx Analyzer 1.0 Printer Setup Guide.</i> For use with software version 1.3.x or higher.
Revision 3 HB-2636-003 01/2021	Added sections on QIASphere settings; network Shares settings; Analytical Module status page, Creating an Epidemiology Report, and System Backup. Updated Figure 30, 33, 34, 44, 61-72, 75, and 76 to reflect updated functionalities. Updated tables on Options for managing assays, available regional settings, available general settings, and HIS/LIS settings. Added a new Troubleshooting procedure for inactive System Update and System Backup buttons. For use with software version 1.4.x or higher.

This page is intentionally left blank.

Trademarks: QIAGEN[®], Sample to Insight[®], QIAstat-Dx[®], DiagCORE[®] (QIAGEN Group); ACGIH[®] (American Conference of Government Industrial Hygienists, Inc.); Brother[®] (Brother Industries, Ltd); Clinical and Laboratory Standards Institute[®] (Clinical Laboratory and Standards Institute, Inc.); Windows[®] (Microsoft Corporation); OSHA[®] (Occupational Safety and Health Administration, U.S. Dept. of Labor); PostScript[®] (Adobe, Inc.); HP[®], LaserJet[®], OfficeJet[®] (Hewlett-Packard Development Company).

Registered names, trademarks, etc. used in this document, even when not specifically marked as such, are not to be considered unprotected by law.

PostScript[®] is either a registered trademark or trademark of Adobe in the United States and/or other countries.

HB-2636-003 01/2021 © 2020 QIAGEN, all rights reserved.

Ordering www.qiagen.com/shop | Technical Support support.qiagen.com | Website www.qiagen.com