

May 2009

TissueLyser LT User Manual

For disruption of up to 12 biological samples



Sample & Assay Technologies

QIAGEN Sample and Assay Technologies

QIAGEN is the leading provider of innovative sample and assay technologies, enabling the isolation and detection of contents of any biological sample. Our advanced, high-quality products and services ensure success from sample to result.

QIAGEN sets standards in:

- Purification of DNA, RNA, and proteins
- Nucleic acid and protein assays
- microRNA research and RNAi
- Automation of sample and assay technologies

Our mission is to enable you to achieve outstanding success and breakthroughs. For more information, visit www.qiagen.com.

Contents

1	Safety Information	5
1.1	Proper use	5
1.2	Electrical safety	6
1.3	Environment	7
1.4	Biological safety	8
1.5	Chemicals	9
1.6	Waste disposal	9
1.7	Mechanical hazards	10
1.8	Hot surface	10
1.9	Noise hazard	10
2	Introduction	11
2.1	About this user manual	11
2.2	Intended use of the TissueLyser LT	11
3	General Description	13
3.1	TissueLyser LT principle	13
3.2	Features of the TissueLyser LT system	13
3.3	Applications	15
4	Installation Procedures	16
4.1	Unpacking the TissueLyser LT	16
4.2	Installation of the TissueLyser LT Adapter	16
4.3	Transporting the TissueLyser LT	17
4.4	Installation requirements	17
4.5	Testing the TissueLyser LT	17
5	Operating Procedures	18
5.1	Sample disruption	18
5.2	Changing the timer settings	19
6	Maintenance Procedures	20
6.1	Regular maintenance	20
7	Troubleshooting Guide	23
7.1	General troubleshooting	23

Appendix A	24
Technical data	24
Waste Electrical and Electronic Equipment (WEEE)	25
Appendix B	26
Warranty statement	26
Liability clause	26

1 Safety Information

Before using the TissueLyser LT system, it is essential that you read this user manual carefully and pay particular attention to the safety information. The instructions and safety information in the user manual must be followed to ensure safe operation of the TissueLyser LT and to maintain the TissueLyser LT in a safe condition.

The following types of safety information appear throughout this user manual.

<p>WARNING</p> 	<p>The term WARNING is used to inform you about situations that could result in personal injury to you or other persons.</p> <p>Details about these circumstances are given in a box like this one.</p>
---------------------------------------------------------------------------------------------------------	-----------------------------------------------------------------------------------------------------------------------------------------------------------------------------------------------------------------------

<p>CAUTION</p> 	<p>The term CAUTION is used to inform you about situations that could result in damage to the TissueLyser LT or other equipment.</p> <p>Details about these circumstances are given in a box like this one.</p>
---------------------------------------------------------------------------------------------------------	-------------------------------------------------------------------------------------------------------------------------------------------------------------------------------------------------------------------------------

The advice given in this manual is intended to supplement, not supersede, the normal safety requirements prevailing in the user's country.

1.1 Proper use

<p>WARNING</p> 	<p>Risk of personal injury and material damage [W1]</p> <p>Improper use of the TissueLyser LT may cause personal injuries or damage to the instrument.</p> <p>The TissueLyser LT should only be operated by qualified personnel who have been appropriately trained.</p> <p>Servicing of the TissueLyser LT should only be performed by QIAGEN or an authorized agent (service technicians).</p>
-----------------------------------------------------------------------------------------------------------	--------------------------------------------------------------------------------------------------------------------------------------------------------------------------------------------------------------------------------------------------------------------------------------------------------------------------------------------------------------------------------------------------------------------------------------------

The TissueLyser LT should only be used for the applications described in the *TissueLyser LT Handbook*. The TissueLyser LT should only be used in combination with the TissueLyser LT Adapter. Do not continue to use the TissueLyser LT or TissueLyser LT Adapter if either is damaged.

Perform the maintenance as described in Section 6. QIAGEN charges for repairs that are required due to incorrect maintenance.

CAUTION 	Damage to the instrument [C1] Avoid spilling water or chemicals onto the TissueLyser LT. Damage caused by water or chemical spillage will void your warranty.
-----------------------------------------------------------------------------------------------------	---------------------------------------------------------------------------------------------------------------------------------------------------------------------------------------------------------------

WARNING 	Risk of personal injury and material damage [W2] Do not attempt to move the TissueLyser LT during operation.
-----------------------------------------------------------------------------------------------------	-----------------------------------------------------------------------------------------------------------------------------------------------------------

In case of emergency, switch off the TissueLyser LT at the power switch and unplug the power supply from the power outlet.

1.2 Electrical safety

WARNING 	Electrical hazard [W3] Any interruption of the protective conductor (earth/ground lead) inside or outside the TissueLyser LT or disconnection of the protective conductor terminal is likely to make the TissueLyser LT dangerous. Intentional interruption is prohibited. Lethal voltages inside the TissueLyser LT When the TissueLyser LT is connected to line power, terminals may be live, and opening the TissueLyser LT or removing parts is likely to expose live parts.
-----------------------------------------------------------------------------------------------------	-------------------------------------------------------------------------------------------------------------------------------------------------------------------------------------------------------------------------------------------------------------------------------------------------------------------------------------------------------------------------------------------------------------------------------------------------------------------------------------------------------------------------------------------------------

To ensure satisfactory and safe operation of the TissueLyser LT, follow the advice below:

- The line power cord must be connected to a line power outlet that has a protective conductor (earth/ground).
- Do not adjust or replace internal parts of the TissueLyser LT.
- Do not operate the TissueLyser LT with any covers or parts removed.
- If liquid has spilled inside the TissueLyser LT, switch off the TissueLyser LT, disconnect it from the power outlet, and contact QIAGEN Technical Services.

- If the TissueLyser LT becomes electrically unsafe, prevent other personnel from operating it, and contact QIAGEN Technical Services; the TissueLyser LT may be electrically unsafe when:
 - It or the line power supply appears to be damaged.
 - It has been stored under unfavorable conditions for a prolonged period.
 - It has been subjected to severe transport stresses.

If the TissueLyser LT is not in use, switch it off at the power switch. If the TissueLyser LT will not be used for a prolonged period of time, unplug the power supply from the power outlet.

In case of power failure, the TissueLyser LT does not automatically restart upon restoration of power. In case of excess current, the TissueLyser LT automatically switches itself off.

1.3 Environment

Operating conditions

WARNING 	Explosive atmosphere [W4] The TissueLyser LT is not designed for use in an explosive atmosphere.
-------------------------------------------------------------------------------------------------------	-----------------------------------------------------------------------------------------------------------------------------------------------

WARNING 	Risk of explosion [W5] The TissueLyser LT is intended for use with reagents and substances supplied with QIAGEN kits. Use of other reagents and substances may lead to fire or explosion.
-------------------------------------------------------------------------------------------------------	----------------------------------------------------------------------------------------------------------------------------------------------------------------------------------------------------------------------------------------

CAUTION 	Damage to the instrument [C2] Direct sunlight may bleach parts of the instrument and cause damage to plastic parts. The TissueLyser LT must be located out of direct sunlight.
-------------------------------------------------------------------------------------------------------	-----------------------------------------------------------------------------------------------------------------------------------------------------------------------------------------------------------------------------

The TissueLyser LT operates correctly under the following conditions:

- Indoors
- Air must not contain any electrically conductive dust

If the TissueLyser LT is operated in an inert gas atmosphere, increased brush sparking on the carbon brushes of the motor may occur, reducing the lifetime of the carbon brushes.

If the TissueLyser LT is operated in a vacuum, problems with the ball bearings, motor, and electronics may occur.

1.4 Biological safety

Specimens and reagents containing materials from humans should be treated as potentially infectious. Use safe laboratory procedures as outlined in publications such as Biosafety in Microbiological and Biomedical Laboratories, HHS (www.cdc.gov/od/ohs/biosfty/biosfty.htm).

Samples

Samples may contain infectious agents. You should be aware of the health hazard presented by such agents and should use, store, and dispose of such samples according to the required safety regulations.

<p>WARNING</p> 	<p>Samples containing infectious agents [W6]</p> <p>Some samples used with the TissueLyser LT may contain infectious agents. Handle such samples with the greatest of care and in accordance with the required safety regulations.</p> <p>Always wear safety glasses, 2 pairs of gloves, and a lab coat.</p> <p>The responsible body (e.g., laboratory manager) must take the necessary precautions to ensure that the surrounding workplace is safe, and that TissueLyser LT operators are suitably trained and not exposed to hazardous levels of infectious agents as defined in the applicable Material Safety Data Sheets (MSDSs) or OSHA,* ACGIH,[†] or COSHH[‡] documents.</p> <p>Venting for fumes and disposal of wastes must be in accordance with all national, state, and local health and safety regulations and laws.</p>
---------------------------------------------------------------------------------------------------------	------------------------------------------------------------------------------------------------------------------------------------------------------------------------------------------------------------------------------------------------------------------------------------------------------------------------------------------------------------------------------------------------------------------------------------------------------------------------------------------------------------------------------------------------------------------------------------------------------------------------------------------------------------------------------------------------------------------------------------------------------------------------------------------------------------------------------------------------------------------

* OSHA: Occupational Safety and Health Administration (United States of America).

[†] ACGIH: American Conference of Government Industrial Hygienists (United States of America).

[‡] COSHH: Control of Substances Hazardous to Health (United Kingdom).

1.5 Chemicals

<p>WARNING</p> 	<p>Hazardous chemicals [W7]</p> <p>Some chemicals used with the TissueLyser LT may be hazardous or may become hazardous after completion of the sample disruption process.</p> <p>Always wear safety glasses, gloves, and a lab coat.</p> <p>The responsible body (e.g., laboratory manager) must take the necessary precautions to ensure that the surrounding workplace is safe and that TissueLyser LT operators are not exposed to hazardous levels of toxic substances (chemical or biological) as defined in the applicable Material Safety Data Sheets (MSDSs) or OSHA,* ACGIH,[†] or COSHH[‡] documents.</p> <p>Venting for fumes and disposal of wastes must be in accordance with all national, state, and local health and safety regulations and laws.</p>
---------------------------------------------------------------------------------------------------------	-------------------------------------------------------------------------------------------------------------------------------------------------------------------------------------------------------------------------------------------------------------------------------------------------------------------------------------------------------------------------------------------------------------------------------------------------------------------------------------------------------------------------------------------------------------------------------------------------------------------------------------------------------------------------------------------------------------------------------------------------------------------------------------------------

* OSHA: Occupational Safety and Health Administration (United States of America).

[†] ACGIH: American Conference of Government Industrial Hygienists (United States of America).

[‡] COSHH: Control of Substances Hazardous to Health (United Kingdom).

Toxic fumes

If working with volatile solvents, toxic substances, etc., you must provide an efficient laboratory ventilation system to remove vapors that may be produced.

<p>WARNING</p> 	<p>Toxic fumes [W8]</p> <p>Do not use bleach to clean or disinfect used labware. Bleach in contact with salts from the buffers used can produce toxic fumes.</p>
-----------------------------------------------------------------------------------------------------------	-------------------------------------------------------------------------------------------------------------------------------------------------------------------------

1.6 Waste disposal

Used labware, such as sample tubes, may contain hazardous chemicals or infectious agents from the sample disruption process. Such wastes must be collected and disposed of properly according to local safety regulations. For information on how to dispose of the TissueLyser LT, see Appendix A (page 24).

1.7 Mechanical hazards

<p>WARNING</p> 	<p>Moving parts [W9]</p> <p>Before installing the TissueLyser LT Adapter, switch off the TissueLyser LT at the power switch.</p> <p>Avoid contact with the TissueLyser LT Adapter during operation of the TissueLyser LT.</p> <p>Do not leave the TissueLyser LT unattended during operation. The instrument may creep along the laboratory bench.</p>
---------------------------------------------------------------------------------------------------------	--------------------------------------------------------------------------------------------------------------------------------------------------------------------------------------------------------------------------------------------------------------------------------------------------------------------------------------------------------------------------------------------------

<p>WARNING</p> 	<p>Moving parts [W10]</p> <p>Damage or personal injury can occur if the TissueLyser LT Adapter is not securely attached.</p>
---------------------------------------------------------------------------------------------------------	------------------------------------------------------------------------------------------------------------------------------------------------------------------------

1.8 Hot surface

<p>WARNING</p> 	<p>Hot surface [W11]</p> <p>The TissueLyser LT Adapter may become very hot after high-speed shaking. The high temperature may also lead to positive pressure within the tubes of the adapter, with a subsequent risk of sample splashing.</p> <p>Always wear safety glasses, gloves, and a lab coat.</p>
-----------------------------------------------------------------------------------------------------------	----------------------------------------------------------------------------------------------------------------------------------------------------------------------------------------------------------------------------------------------------------------------------------------------------------------------------------------------------

Do not operate the TissueLyser LT for longer than 10 minutes without pausing at regular intervals to allow the instrument to cool down. Check the TissueLyser LT Adapter and tighten if necessary.

1.9 Noise hazard

<p>WARNING</p> 	<p>Noise hazard [W12]</p> <p>Wear ear protection to protect ears from noise levels of 85 dB(A) or above.</p>
-----------------------------------------------------------------------------------------------------------	--------------------------------------------------------------------------------------------------------------------------------------------------------

2 Introduction

Thank you for choosing the TissueLyser LT system. We are confident it will become an integral part of your laboratory.

Before using the TissueLyser LT, it is essential you read this user manual carefully and pay particular attention to the safety information. The instructions and safety information in the user manual must be followed to ensure safe operation of the TissueLyser LT and to maintain the TissueLyser LT in a safe condition.

2.1 About this user manual

This user manual provides information about the TissueLyser LT in the following sections:

1. Safety Information
 2. Introduction
 3. General Description
 4. Installation Procedures
 5. Operating Procedures
 6. Maintenance Procedures
 7. Troubleshooting Guide
- Appendices

The appendices contain the following:

- Technical data
- Warranty terms

2.2 Intended use of the TissueLyser LT

The TissueLyser LT is intended for molecular biology applications. This product is neither intended for the diagnosis, prevention, or treatment of a disease, nor has it been validated for such use either alone or in combination with other products. Therefore, the performance characteristics of the product for clinical use (i.e., diagnostic, prognostic, therapeutic, or blood banking) are unknown.

Requirements for TissueLyser LT users

This table covers the general level of competence and training necessary for transportation, installation, use, maintenance, and servicing of the TissueLyser LT.

Task	Personnel	Training and experience
Transportation	No special requirements	No special requirements
Installation, routine use, and maintenance	Laboratory technicians or equivalent	Appropriately trained and experienced personnel
Servicing	QIAGEN or an authorized agent (service technicians)	

3 General Description

The TissueLyser LT is a compact bead mill designed for rapid, efficient, and flexible disruption of up to 12 samples at the same time. A wide variety of biological samples can be processed, including human, animal, and plant tissues. Each sample is simultaneously disrupted and homogenized by high-speed shaking with a bead in a sealed tube (bead milling).

3.1 TissueLyser LT principle

Efficient sample disruption is a prerequisite for nucleic acid and protein purification procedures. Incomplete sample disruption can lead to significantly reduced yields and can increase the risk of clogging when using purification columns or magnetic particles. The TissueLyser LT thoroughly disrupts and simultaneously homogenizes biological samples in the presence of lysis buffer. Plant tissues can alternatively be disrupted and homogenized in the absence of lysis buffer. Tubes containing sample and bead are placed in the TissueLyser LT Adapter and shaken up and down at a very high speed, causing the samples to be disrupted and homogenized by the beating and grinding effect of the beads. When processing plant tissues or unstabilized animal and human tissues, the TissueLyser LT Adapter passively cools the sample tubes during the disruption process to prevent degradation of biomolecules.

3.2 Features of the TissueLyser LT system

TissueLyser LT

This compact instrument provides high-speed vertical shaking with oscillation frequencies of 15–50 Hz. Power is switched on and off at the power switch located on the right-hand side of the instrument. Oscillation frequency can be adjusted in steps of 1 Hz using a keypad located on top of the instrument. Disruption time, up to a maximum of 1 hour 59 minutes, can also be set using the keypad.

TissueLyser LT Adapter

The TissueLyser LT Adapter enables the TissueLyser LT to disrupt and homogenize up to 12 samples at the same time. The TissueLyser LT Adapter is connected to the piston of the TissueLyser LT and securely holds up to twelve 2 ml tubes (Figure 1). For disruption of plant tissues in the absence of lysis buffer or disruption of unstabilized animal and human tissues, the TissueLyser LT Adapter can be precooled on dry ice before use.

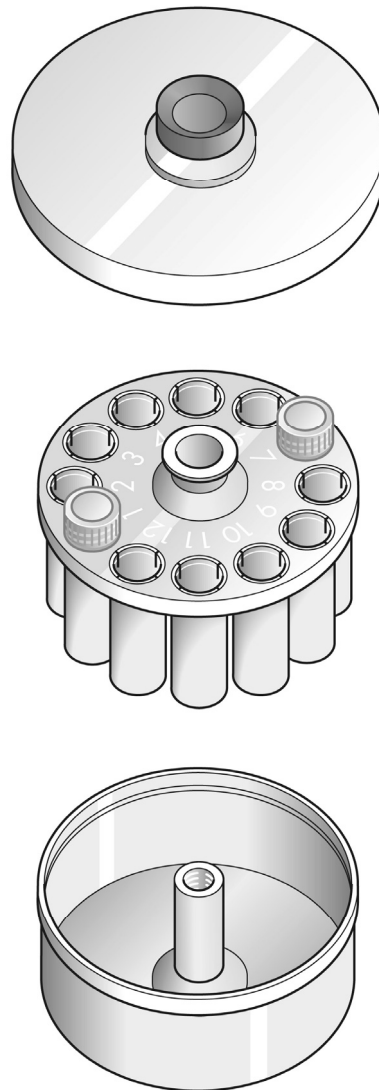

Figure 1. TissueLyser LT Adapter. At the bottom of the figure is the base of the TissueLyser LT Adapter, which has to be attached to the piston of the TissueLyser LT. In the middle of the figure is the insert of the TissueLyser LT Adapter, which contains 12 aluminum tube holders to hold 2 ml tubes. At the top of the figure is the lid of the TissueLyser LT Adapter, which contains a knob to securely screw the lid onto the base of the TissueLyser LT Adapter.

Sample tubes

The TissueLyser LT Adapter is used with Sample Tubes RB (2 ml) (cat. no. 990381) from QIAGEN. The tubes can be discarded after use, which prevents cross-contamination and provides time savings, as there is no need to clean tubes after disrupting samples. In addition, there is no cross-contamination during sample disruption as each tube is securely sealed with its own lid.

Power supply

The 24 V power supply (which plugs into the TissueLyser LT) enables connection of the TissueLyser LT to a power outlet.

3.3 Applications

The TissueLyser LT enables disruption and homogenization of:

- Human and animal tissues
- Human and animal cells
- Plant tissues
- Yeast
- Gram-positive and gram-negative bacteria

For information about specific applications and protocols for sample disruption, see the *TissueLyser LT Handbook*.

4 Installation Procedures

4.1 Unpacking the TissueLyser LT

Before unpacking the TissueLyser LT, check whether the package is damaged. In case of damage, contact the transporter of the package.

Lift the TissueLyser LT out of the packaging with both hands below the base of the instrument.

After unpacking the TissueLyser LT, check that the following items are supplied:

- TissueLyser LT with power supply
- Power cables for different countries
- Allen key
- *TissueLyser LT User Manual*
- *TissueLyser LT Handbook*

If anything is missing, contact QIAGEN Technical Services.

Check that the TissueLyser LT is not damaged. If anything is damaged, contact QIAGEN Technical Services. Make sure that the TissueLyser LT has equilibrated to ambient temperature before operating it.

Retain the package in case you need to transport the TissueLyser LT in the future. Using the original package minimizes damage during transportation of the TissueLyser LT.

4.2 Installation of the TissueLyser LT Adapter

The TissueLyser LT Adapter is not included in the package and has to be ordered separately (cat. no. 69980).

Attach the TissueLyser LT Adapter to the TissueLyser LT as follows:

- Screw the base of the adapter onto the piston of the TissueLyser LT
- Using the Allen key, securely tighten the screw on top of the adapter base onto the piston
- Place the insert with aluminum tube holders into the base
- Place the lid of the adapter over the insert
- Screw the knob of the lid until it is securely attached to the base of the TissueLyser LT Adapter

WARNING	Moving parts [W10]
	Damage or personal injury can occur if the TissueLyser LT Adapter is not securely attached.

4.3 Transporting the TissueLyser LT

Carry the TissueLyser LT with both hands below the base of the instrument. Do not carry the TissueLyser LT by holding the TissueLyser LT Adapter.

4.4 Installation requirements

Site requirements

Place the TissueLyser LT on a flat, stable surface, and ensure that there is sufficient space around and under the instrument for ventilation. Leave some space to the right of the instrument for the power switch and power supply. The TissueLyser LT is for indoor use only under the following conditions:

- Room temperature within the range of 5–40°C (41–104°F)
- Up to 2000 m (6500 ft.) above mean sea level (MSL)
- Maximum relative humidity of 80% for temperatures up to 31°C, linearly decreasing down to a relative humidity of 50% at 40°C
- Contamination level 2 (IEC 664)

Power requirements

The power line to the TissueLyser LT should be voltage-regulated and surge-protected.

The power supply of the TissueLyser LT is compatible with voltages of 100–240 V.

Make sure that the voltage rating of the TissueLyser LT power supply is compatible with the AC voltage available at the installation site.

Grounding requirements

To protect operating personnel, the National Electrical Manufacturers' Association (NEMA) recommends that the TissueLyser LT be correctly grounded (earthed). The power supply should be plugged into an AC power outlet that has a ground (earth) connection.

4.5 Testing the TissueLyser LT

After carrying out the installation described in Sections 4.1–4.4 and before using the TissueLyser LT for the first time, check that the instrument functions properly by following the procedure described in Section 5.1, page 18.

5 Operating Procedures

This section describes how to operate the TissueLyser LT system. Before proceeding, you should familiarize yourself with the features of the TissueLyser LT by referring to Section 3, pages 13–15.

5.1 Sample disruption

The procedure below describes how to disrupt samples using the TissueLyser LT. For detailed information about sample disruption and protocols, see the *TissueLyser LT Handbook*.

1. Make sure that the TissueLyser LT Adapter is securely installed on the piston of the TissueLyser LT (see Section 4.2, page 16).

WARNING 	Moving parts Damage or personal injury can occur if the TissueLyser LT Adapter is not securely attached.	[W10]
-----------------------------------------------------------------------------------------------------	--------------------------------------------------------------------------------------------------------------------	-------

2. Make sure that the power supply is connected to the TissueLyser LT and to a power outlet.
3. Switch on the TissueLyser LT using the power switch. The display lights will flash.
4. Using the appropriate “+” or “-” keys on the keypad, set the disruption time and the oscillation frequency.

For optimal disruption time and oscillation frequency, see the *TissueLyser LT Handbook*. If testing the TissueLyser LT, use a disruption time of a few seconds and an oscillation frequency of approx. 50 Hz.

Note: Disruption time is displayed either as hours and minutes or as minutes and seconds. To change the setting, see Section 5.2, page 19.

5. Press the “Start” key on the keypad. The TissueLyser LT will now operate at the frequency specified in step 4. In addition, the timer on the TissueLyser LT will count down the disruption time (i.e., the timer shows the time remaining).

WARNING 	Moving parts Avoid contact with the TissueLyser LT Adapter during operation of the TissueLyser LT. Do not leave the TissueLyser LT unattended during operation. The instrument may creep along the laboratory bench.	[W9]
-------------------------------------------------------------------------------------------------------	-----------------------------------------------------------------------------------------------------------------------------------------------------------------------------------------------------------------------------------	------

6. When the timer reaches zero, the TissueLyser LT stops operating. To stop the TissueLyser LT before the timer reaches zero, press the "Stop" key on the keypad. To restart the TissueLyser LT from where the timer stopped, press the "Start" key.
7. When the TissueLyser LT is no longer in operation, switch it off at the power switch.

5.2 Changing the timer settings

The timer on the TissueLyser LT displays the disruption time either as hours and minutes or as minutes and seconds. The TissueLyser LT is delivered with the timer set to display minutes and seconds. To change the time format, follow the procedure below.

1. Press and hold the "Stop" key for 5 seconds. The timer will go into setup mode.
2. Using the "+" and "-" keys, select 0 to display disruption time as hours and minutes, or select 1 to display disruption time as minutes and seconds.
3. Press the "Stop" key to save your selection.

Note: The TissueLyser LT and TissueLyser LT Adapter reach very high temperatures after 10 minutes of operation. When using long disruption times, we strongly recommend stopping the instrument at regular intervals to allow it to cool down.

6 Maintenance Procedures

Perform the following regular maintenance procedures (i.e., after each daily use) to ensure reliable operation of the TissueLyser LT.

CAUTION 	Damage to the instrument [C3] Do not use bleach, solvents, or reagents containing acids, alkalis, or abrasives to clean the TissueLyser LT.
-----------------------------------------------------------------------------------------------------	------------------------------------------------------------------------------------------------------------------------------------------------------------------------------------------

If solvents or saline, acidic, or alkaline solutions are spilt on the TissueLyser LT, wipe them away immediately.

Do not autoclave any part of the TissueLyser LT or the TissueLyser LT Adapter.

WARNING 	Risk of electric shock [W13] Do not open any panels on the TissueLyser LT. Risk of personal injury and material damage Only perform maintenance that is specifically described in this user manual.
-----------------------------------------------------------------------------------------------------	---------------------------------------------------------------------------------------------------------------------------------------------------------------------------------------------------------------------------------------------------------------

Servicing

The TissueLyser LT is supplied with a warranty that lasts for 12 months, starting from the date of shipment. The warranty includes all repairs due to mechanical breakdown.

6.1 Regular maintenance

The TissueLyser LT should be wiped after use using a soft cloth moistened with a suitable cleaning agent (see below). Be sure to switch off the TissueLyser LT at the power switch and unplug the power adapter from the power socket before cleaning. If the TissueLyser LT is switched on, there may be a risk of the instrument inadvertently starting during cleaning.

The components of the TissueLyser LT Adapter should be cleaned after use using a suitable cleaning agent (see below), rinsed with distilled water, and then dried using paper towels.

If the TissueLyser LT is contaminated with infectious material, it should be decontaminated. The TissueLyser LT should also be decontaminated before shipping, and a decontamination certificate must be completed to certify that the instrument has been decontaminated.

Cleaning agents

The following disinfectants and detergents are recommended for cleaning the TissueLyser LT.

Note: If you want to use disinfectants different from those recommended, ensure that their compositions are similar to those described below.

General cleaning:

- Mild detergents
- 70% ethanol

Disinfection:

- Ethanol-based disinfectants can be used for disinfection of surfaces: e.g., 25 g ethanol and 35 g 1-propanol per 100 g liquid or Mikrozid® Liquid (Schülke & Mayr GmbH, cat. no. 109160)
- Disinfectants based on glyoxal and quaternary ammonium salt can be used for submerging the TissueLyser LT Adapter: e.g., 10 g glyoxal, 12 g lauryldimethylbenzylammonium chloride, 12 g myristyldimethylbenzylammonium chloride, and 5–15% nonionic detergent per 100 g liquid, Lysetol® AF (Gigasept® Instru AF in Europe, cat. no. 107410, or DECON-QUAT® 100, Veltek Associates, Inc., in the USA, cat. no. DQ100-06-167-01)

Removal of RNase contamination:



- RNaseZap® RNase Decontamination Solution (Ambion, Inc., cat. no. AM9780) can be used for cleaning surfaces and submerging the TissueLyser LT Adapter

Removal of nucleic acid contamination:

- DNA-ExitusPlus™ (AppliChem, cat. no. A7089,0100) can be used for cleaning surfaces and submerging the TissueLyser LT Adapter

General instructions:

- Do not use spray bottles to spray cleaning or disinfectant liquids onto surfaces of the TissueLyser LT
- If solvents or saline, acidic, or alkaline solutions are spilt on the TissueLyser LT, wipe the spilt liquid away immediately
- Follow manufacturer's safety instructions for handling cleaning agents
- Follow manufacturer's instructions for soaking time and concentration of cleaning agents: exposure for longer than the recommended soaking time can damage the instrument

WARNING 	Toxic fumes [W8] Do not use bleach to clean or disinfect used labware. Bleach in contact with salts from the buffers used can produce toxic fumes.
CAUTION 	Damage to the instrument [C3] Do not use bleach, solvents, or reagents containing acids, alkalis, or abrasives to clean the TissueLyser LT.
CAUTION 	Damage to the instrument [C1] Avoid spilling water or chemicals onto the TissueLyser LT. Damage caused by water or chemical spillage will void your warranty.

7 Troubleshooting Guide

7.1 General troubleshooting

Comments and suggestions

No display

Power supply not connected; power switch in "off" position	Connect the TissueLyser LT to the power supply. Switch on the TissueLyser LT using the power switch.
------------------------------------------------------------	------------------------------------------------------------------------------------------------------

TissueLyser LT slows down

- | | |
|-----------------------------------------------------------------|-------------------------------------------------------------------------------------------|
| a) TissueLyser LT Adapter is overloaded | Press the "Stop" key. Reduce the load in the TissueLyser LT Adapter, and start again. |
| b) Piston has overheated and expanded, making movement sluggish | Reduce the load in the TissueLyser LT Adapter, and allow the TissueLyser LT to cool down. |

TissueLyser LT stops

- | | |
|---------------------------|---------------------------------------------------------------------------------------------------------------------------------|
| a) Drive has overheated | Allow the TissueLyser LT to cool down. |
| b) Drive is blocked | Remove all possible obstacles that may block the movement of the TissueLyser LT Adapter. If the error persists, contact QIAGEN. |
| c) Speed sensor defective | Contact QIAGEN. |

Sample leaks out of the sample tubes

- | | |
|---------------------------------------------------------------------------|----------------------------------------------------------------------------------------------------------------------------------------------------------------------------------------------------------------------------------------------------------------------|
| a) Lid of TissueLyser LT Adapter loose | Tighten the lid securely by screwing the knob on top of the lid clockwise. |
| b) Grinding beads too heavy | Only use grinding beads recommended in the <i>TissueLyser LT Handbook</i> . |
| c) Wrong sample tubes used | Only use sample tubes recommended in this user manual (see page 14). Other tubes may not be strong enough to withstand the impact of the grinding beads during sample disruption. |
| d) TissueLyser LT Adapter and/or sample tubes cooled with liquid nitrogen | Cool down the TissueLyser LT Adapter and the sample tubes on dry ice or in a freezer not exceeding -80°C . If the adapter or the sample tubes are cooled in liquid nitrogen, the sample tubes may become brittle and crack during sample disruption. |

Appendix A

Technical data

Environmental conditions

Voltage	100–240 V AC, 50–60 Hz (external 24 V power supply designed for wide range of input voltages; maximum power consumption approx. 30 W)
Place of operation	For indoor use only
Air temperature	5–40°C (41–104°F)
Relative humidity	Maximum 80% (for temperatures up to 31°C; linearly decreasing down to a relative humidity of 50% at 40°C)
Altitude	Up to 2000 m (6500 ft.) above mean sea level (MSL)
Contamination level	2 (IEC 664)

Mechanical data

Dimensions	Height: 280 mm Width: 150 mm Depth: 270 mm
Mass	Approx. 7.35 kg (net); approx. 9 kg (gross)
Oscillation frequency	15–50 Hz
Noise level	<85 dB(A)

Waste Electrical and Electronic Equipment (WEEE)

This section provides information about disposal of waste electrical and electronic equipment by users in the European Union.

The European Directive 2002/96/EC on WEEE requires proper disposal of electrical and electronic equipment when it reaches its end of life. The crossed-out wheeled bin symbol (see below) indicates that this product must not be disposed of with other waste; it must be taken to an approved treatment facility or to a designated collection point for recycling, according to local legislation. The separate collection and recycling of waste electronic equipment at the time of disposal helps to conserve natural resources and ensures that the product is recycled in a manner that protects human health and the environment.



QIAGEN accepts its responsibility in accordance with the specific WEEE recycling requirements and, where a replacement product is being supplied by QIAGEN, provides free recycling of its WEEE-marked electronic equipment in Europe. If a replacement product is not being purchased from QIAGEN, recycling can be provided upon request at additional cost. To recycle electronic equipment, contact your local QIAGEN sales office for the required return form. Once the form is submitted, you will be contacted by QIAGEN either to request follow-up information for scheduling collection of the electronic waste or to provide you with an individual quote.

Appendix B

Warranty statement

Thank you for your purchase of QIAGEN instrumentation. Your instrument has been carefully tested to ensure optimum operating efficiency and reproducibility of results. QIAGEN warrants that all new instrumentation manufactured by QIAGEN will correspond to the product specifications and be free from defects in workmanship and materials for a period of twelve (12) months from the original date of shipment (see page 20). Repair or replacement of defective parts will be provided to the purchaser during this time period provided the QIAGEN instrumentation is operated under conditions of normal and proper use, but not for damage caused by the customer. If any part or subassembly proves to be defective, it will be repaired or replaced at QIAGEN's sole option, subsequent to inspection at the factory, or in the field by an authorized factory representative, provided that such defect manifested under normal and proper use.

Limitation of warranties and remedies

THE FOREGOING WARRANTY IS QIAGEN'S SOLE AND EXCLUSIVE WARRANTY, AND REPAIR OR REPLACEMENT OF DEFECTIVE PARTS IS THE SOLE AND EXCLUSIVE REMEDY. THERE ARE NO OTHER WARRANTIES OR GUARANTEES, EXPRESS OR IMPLIED. THE IMPLIED WARRANTIES OF MERCHANTABILITY AND FITNESS FOR A PARTICULAR PURPOSE ARE EXPRESSLY EXCLUDED, TO THE FULLEST EXTENT PERMITTED BY LAW. (NOTE: SOME STATES DO NOT PERMIT DISCLAIMERS OF IMPLIED WARRANTIES SO THIS LIMITATION MAY NOT APPLY TO YOU). WITH THE EXCEPTION OF THE ABOVE-REFERENCED REPAIR OR REPLACEMENT REMEDY, QIAGEN SHALL HAVE NO OBLIGATION OR LIABILITY OF ANY NATURE WHATSOEVER WITH RESPECT TO THE QIAGEN INSTRUMENTATION, WHETHER ARISING IN CONTRACT, TORT, STRICT LIABILITY, OR OTHERWISE, INCLUDING BUT NOT LIMITED TO, LIABILITY FOR INDIRECT, CONSEQUENTIAL, INCIDENTAL AND/OR SPECIAL, PUNITIVE, MULTIPLE AND/OR EXEMPLARY DAMAGES AND/OR OTHER LOSSES (INCLUDING LOSS OF USE, LOST REVENUES, LOST PROFITS AND DAMAGE TO REPUTATION), EVEN IF SUCH DAMAGES WERE FORESEEN OR FORSEEABLE, OR WERE BROUGHT TO QIAGEN'S ATTENTION. IN NO EVENT SHALL QIAGEN'S LIABILITY TO YOU EXCEED THE PURCHASE PRICE OF THE PRODUCT.

Liability clause

QIAGEN shall be released from all obligations under its warranty in the event repairs or modifications are made by persons other than its own personnel, except in cases where the Company has given its written consent to perform such repairs or modifications.

All materials replaced under this warranty will be warranted only for the duration of the original warranty period, and in no case beyond the original expiration date of original warranty unless authorized in writing by an officer of the Company. Read-out devices, interfacing devices and associated software will be warranted only for the period offered by the original manufacturer of these products. Representations and warranties made by any person, including representatives of QIAGEN, which are inconsistent or in conflict with the conditions in this warranty shall not be binding upon the Company unless produced in writing and approved by an officer of QIAGEN.

Trademarks: QIAGEN® (QIAGEN Group); DNA-ExitusPlus™ (AppliChem); Gigasept®, Lysetol®, Mikrozyd® (Schülke & Mayr GmbH); DECON-QUAT® (Veltek Associates, Inc.); RNaseZap® (Ambion, Inc.).

© 2009 QIAGEN, all rights reserved.

www.qiagen.com

Australia ■ Orders 03-9840-9800 ■ Fax 03-9840-9888 ■ Technical 1-800-243-066

Austria ■ Orders 0800/28-10-10 ■ Fax 0800/28-10-19 ■ Technical 0800/28-10-11

Belgium ■ Orders 0800-79612 ■ Fax 0800-79611 ■ Technical 0800-79556

Brazil ■ Orders 0800-557779 ■ Fax 55-11-5079-4001 ■ Technical 0800-557779

Canada ■ Orders 800-572-9613 ■ Fax 800-713-5951 ■ Technical 800-DNA-PREP (800-362-7737)

China ■ Orders 0086-21-3865-3865 ■ Fax 0086-21-3865-3965 ■ Technical 800-988-0325, 800-988-0327

Denmark ■ Orders 80-885945 ■ Fax 80-885944 ■ Technical 80-885942

Finland ■ Orders 0800-914416 ■ Fax 0800-914415 ■ Technical 0800-914413

France ■ Orders 01-60-920-926 ■ Fax 01-60-920-925 ■ Technical 01-60-920-930 ■ Offers 01-60-920-928

Germany ■ Orders 02103-29-12000 ■ Fax 02103-29-22000 ■ Technical 02103-29-12400

Hong Kong ■ Orders 800 933 965 ■ Fax 800 930 439 ■ Technical 800 930 425

Ireland ■ Orders 1800 555 049 ■ Fax 1800 555 048 ■ Technical 1800 555 061

Italy ■ Orders 02-33430-420 ■ Fax 02-33430-426 ■ Technical 800-787980

Japan ■ Telephone 03-6890-7300 ■ Fax 03-5547-0818 ■ Technical 03-6890-7300

Korea (South) ■ Orders 1544 7145 ■ Fax 1544 7146 ■ Technical 1544 7145

Luxembourg ■ Orders 8002-2076 ■ Fax 8002-2073 ■ Technical 8002-2067

Mexico ■ Orders 01-800-7742-639 ■ Fax 01-800-1122-330 ■ Technical 01-800-7742-639

The Netherlands ■ Orders 0800-0229592 ■ Fax 0800-0229593 ■ Technical 0800-0229602

Norway ■ Orders 800-18859 ■ Fax 800-18817 ■ Technical 800-18712

Singapore ■ Orders 65-67775366 ■ Fax 65-67785177 ■ Technical 65-67775366

Spain ■ Orders 91-630-7050 ■ Fax 91-630-5145 ■ Technical 91-630-7050

Sweden ■ Orders 020-790282 ■ Fax 020-790582 ■ Technical 020-798328

Switzerland ■ Orders 055-254-22-11 ■ Fax 055-254-22-13 ■ Technical 055-254-22-12

UK ■ Orders 01293-422-911 ■ Fax 01293-422-922 ■ Technical 01293-422-999

USA ■ Orders 800-426-8157 ■ Fax 800-718-2056 ■ Technical 800-DNA-PREP (800-362-7737)

