

May 2020

QIAgility[®] Version 4.18 User Manual

Trademarks

QIAGEN®, QIAgility®, QIAxcel®, Rotor-Gene® (QIAGEN Group); DECON-QUAT® (Veltek Associates Inc.); Gigasept®, Mikroqid®, Lysetol® (Schülke & Mayr GmbH); Microcide SQ™ (Global Biotechnologies, Inc.); Excel®, Microsoft®, Windows® (Microsoft Corporation). Registered names, trademarks, etc. used in this document, even when not specifically marked as such, are not to be considered unprotected by law.

© 2020 QIAGEN, all rights reserved.

Contents

1	Safety Information	1-1
1.1	Proper Use	1-1
1.2	Electrical safety	1-3
1.3	Biological safety	1-4
1.3.1	Samples	1-4
1.4	Chemicals	1-5
1.4.1	Toxic fumes	1-6
1.5	Waste disposal	1-6
1.6	Mechanical Hazards	1-7
1.7	Maintenance safety	1-8
1.8	Symbols on the QIAgility	1-9
2	Introduction	2-1
2.1	About this user manual	2-1
2.2	General information	2-2
2.2.1	Technical assistance	2-2
2.2.2	Policy statement	2-3
2.2.3	Version management	2-3
2.3	Intended use of the QIAgility	2-3
2.3.1	Requirements for QIAgility users	2-4
3	General Description	3-1
3.1	QIAgility principle	3-1
3.2	The QIAgility	3-2
3.2.1	Instrument lid (1)	3-3
3.2.2	Feet (2)	3-3
3.2.3	Tip chute (3)	3-4
3.2.4	HEPA filter (4)	3-4
3.2.5	UV lamp (5)	3-5

Contents

3.2.6	Pipetting head (6) and robotic arm	3-6
3.2.7	Worktable	3-6
3.2.8	Tip disposal box	3-6
3.2.9	Accessory panel	3-7
3.2.10	Internal features of the QIAgility	3-8
3.3	Liquid-level tracking	3-13
3.4	Computer	3-14
4	Installation Procedures	4-1
4.1	Instrument delivery and installation	4-1
4.2	Requirements	4-1
4.3	AC power connection	4-3
4.4	Unpacking the QIAgility	4-3
4.5	Installing the QIAgility	4-5
4.5.1	UV lamp	4-7
4.5.2	HEPA filter system	4-7
4.5.3	Instrument calibration	4-7
4.5.4	Computer setup and installation of software	4-7
4.6	Software installation	4-8
4.6.1	Uninstalling QIAgility software	4-15
4.7	Folders	4-16
4.7.1	“QProtocols” folder	4-17
4.7.2	Connecting the computer to the QIAgility	4-18
4.7.3	COM port configuration	4-18
4.7.4	Installation of AC power cord	4-19
4.8	Hardware Wizard	4-19
4.9	Setting up the QIAgility	4-21
5	QIAgility Software	5-1
5.1	Starting the software	5-1
5.2	Virtual Mode	5-2

5.3	Main software window	5-3
5.3.1	Menu bar	5-4
5.3.2	Toolbar	5-14
5.3.3	Mode indicator	5-16
5.3.4	Software workspace	5-16
5.4	User management	5-21
5.4.1	User identification	5-21
5.4.2	User classes	5-21
5.4.3	Enabling access control	5-24
5.4.4	Managing user groups	5-24
5.4.5	Change current user	5-26
5.4.6	Revert to first user	5-27
5.5	Manage calibration data	5-27
5.5.1	Save calibrations on setup disk	5-27
5.5.2	Load calibrations from setup disk	5-28
5.5.3	Delete multiple calibrations	5-29
5.6	Configure run settings	5-30
5.6.1	Configure tip air intake	5-31
5.6.2	Configure pipet speed	5-31
5.6.3	Set master mix extra volume	5-33
5.6.4	Set standard extra volume	5-34
5.6.5	Set concentration unit	5-34
5.6.6	Allow use of multiple reagent volumes	5-35
5.6.7	Set default file location	5-36
5.6.8	Configure system color	5-37
5.6.9	Adjust liquid level-tracking options	5-39
5.6.10	Set liquid-level tracking error level	5-40
5.6.11	Set tip usage options	5-42
5.6.12	Configure multi-eject options	5-44
5.7	Define worktable setup	5-45
5.7.1	Plate operations	5-45
5.7.2	Setting tip availability	5-53
5.8	Managing samples	5-54

Contents

5.8.1	Managing sample banks	5-54
5.9	View and edit information using the right-hand pane	5-59
5.9.1	Tip	5-59
5.9.2	Standards	5-60
5.9.3	Reagents	5-65
5.9.4	Master Mix	5-67
5.9.5	Samples	5-77
5.9.6	Reactions	5-81
5.9.7	Importing and exporting reaction and sample data	5-112
5.9.8	Progress report	5-127
5.10	Programming run files	5-127
5.10.1	PCR Setup Wizard	5-127
5.10.2	Optimisation Wizard	5-136
5.10.3	Using "Empty Project"	5-142
5.10.4	Example reactions	5-143
5.10.5	Checking the reaction setup	5-146
5.10.6	Required volumes for reaction setup	5-146
5.11	Selecting the COM port	5-146
5.12	Service register	5-147
6	Operating Procedures	6-1
6.1	Starting the software	6-1
6.2	Using the UV lamp	6-3
6.3	Operating the HEPA filter	6-5
6.4	Executing a run	6-5
6.4.1	Q Protocols	6-5
6.4.2	Selecting a saved run file	6-8
6.4.3	Creating a new run file	6-9
6.4.4	Preparing the worktable	6-10
6.4.5	Starting a run	6-11
6.5	Pausing/aborting a run	6-12
6.6	Exception handling	6-13

6.7	Reports/log files	6-14
6.7.1	Pre-run report	6-14
6.7.2	Post-run report	6-16
6.7.3	Log files and support packages	6-17
6.8	Importing and exporting reaction/sample data	6-20
6.9	Shutting down the software and the instrument	6-20
7	Instrument Setup and Calibration	7-1
7.1.1	Setup tip ejector	7-1
7.1.2	Calibrate plate positions	7-4
7.1.3	Calibrate plate heights	7-7
7.1.4	Optimal height calibration	7-11
7.1.5	Calibrate tip offsets	7-11
7.1.6	Calibrate volumes	7-14
8	Maintenance Procedures	8-1
8.1	Regular maintenance	8-2
8.1.1	Cleaning the QIAgility	8-2
8.2	Periodic maintenance	8-3
8.2.1	Decontaminating the QIAgility	8-3
8.2.2	Removing and replacing the tip ejector chute	8-4
8.2.3	Replacing the HEPA filter	8-5
9	Troubleshooting	9-1
9.1	System setup	9-1
9.2	Operation	9-2
9.3	Warnings and errors	9-5
9.3.1	Warning and error messages	9-5
9.3.2	Instrument error codes	9-8
9.4	Self diagnostic tools	9-10
9.4.1	Mechanical tests	9-11
9.4.2	Electrical tests	9-12

10	Glossary	10-1
	Appendix A	1
	Technical data	1
	Environmental conditions	1
	Waste Electrical and Electronic Equipment (WEEE)	2
	FCC declaration	3
	Declaration of conformity	4
	Appendix B	1
	Liability clause	1
	Appendix C	1
	Safety Information (French, FR)	1
1	Consignes de sécurité	1
1.1	Utilisation appropriée	2
1.2	Sécurité électrique	4
1.3	Sécurité biologique	5
1.3.1	Échantillons	5
1.4	Produits chimiques	7
1.4.1	Vapeurs toxiques	7
1.5	Traitement des déchets	7
1.6	Dangers mécaniques	8
1.7	Sécurité relative à la maintenance	9
1.8	Symboles sur le QIAgility	10
	Appendix D	1
	Safety Information (German, DE)	1

1	Sicherheitshinweise	1
1.1	Sachgemäße Handhabung	2
1.2	Elektrische Sicherheit	3
1.3	Biologische Sicherheit	5
1.3.1	Proben	5
1.4	Chemikalien	7
1.4.1	Giftige Dämpfe	7
1.5	Abfallentsorgung	7
1.6	Gefahren durch mechanische Teile	8
1.7	Sicherheitshinweise – Wartungsarbeiten	9
1.8	Symbole auf dem QIAgility	11
	Appendix E	1
	ABI 7000/7500 SDS master mix naming conventions	1
	Appendix F	1
	Advanced Settings	1
	Appendix G	1
	Description of the Generic XML Format	1
	Appendix H	1
	Packing the QIAgility	1
	Appendix G	2
	Copyright Information	2
	Index 1	

This page intentionally left blank

1 Safety Information

Before using the QIAgility, it is essential that you read this user manual carefully and pay particular attention to the safety information. The instructions and safety information in the user manual must be followed to ensure safe operation of the instrument and to maintain the instrument in a safe condition.

Note: Translations of the Safety Information in French and German are available in Appendix C and Appendix D.

The following types of safety information appear throughout this manual.







WARNING 	The term WARNING is used to inform you about situations that could result in personal injury to you or other persons. Details about these circumstances are given in a box like this one.
---	---

CAUTION 	The term CAUTION is used to inform you about situations that could result in damage to the instrument or other equipment. Details about these circumstances are given in a box like this one.
---	---

The advice given in this manual is intended to supplement, not supersede, the normal safety requirements prevailing in the user's country.

1.1 Proper Use

Safety Information

<p>WARNING/ CAUTION</p> 	<p>Risk of personal injury and material damage [W1] Improper use of the QIAgility may cause personal injuries or damage to the instrument. The QIAgility must only be operated by qualified personnel who have been appropriately trained. Servicing of the QIAgility must only be performed by QIAGEN Field Service Specialists.</p>
<p>WARNING/ CAUTION</p> 	<p>Risk of overheating [W2] To ensure proper ventilation, maintain a minimum clearance of 10 cm at the sides and rear of the QIAgility. Slits and openings that ensure the ventilation of the QIAgility must not be covered.</p>
<p>WARNING/ CAUTION</p> 	<p>Risk of personal injury and material damage [W3] The QIAgility is too heavy to be lifted by one person. To avoid personal injury or damage to the instrument, do not lift the instrument alone.</p>
<p>WARNING/ CAUTION</p> 	<p>Risk of personal injury and material damage [W4] Do not attempt to move the QIAgility during operation.</p>
<p>WARNING/ CAUTION</p> 	<p>Explosive atmosphere [W5] The QIAgility is not designed for use in an explosive atmosphere.</p>
<p>WARNING/ CAUTION</p> 	<p>Risk of explosion [W6] The QIAgility is intended for use with reagents and substances supplied with QIAGEN kits. Use of other reagents and substances may lead to fire or explosion.</p>

<p>CAUTION</p> 	<p>Damage to the instrument [C1]</p> <p>Direct sunlight may bleach parts of the instrument and cause damage to plastic parts. The QIAgility must be located out of direct sunlight.</p>
---	---

<p>CAUTION</p> 	<p>Damage to the instrument [C2]</p> <p>Avoid spilling water or chemicals onto the QIAgility. Damage caused by water or chemical spillage will void your warranty.</p>
---	--

<p>WARNING</p> 	<p>Risk of personal injury [W7]</p> <p>The robotic arm moves during position calibration while the instrument lid is raised. Never click any buttons while parts of your body are within the instrument workspace.</p>
---	--

In case of emergency, switch off the QIAgility at the power switch at the rear of the instrument and unplug the power cord from the power outlet.

1.2 Electrical safety

Disconnect the line power cord from the power outlet before servicing.

<p>WARNING</p> 	<p>Electrical hazard [W8]</p> <p>Any interruption of the protective conductor (earth/ground lead) inside or outside the instrument or disconnection of the protective conductor terminal is likely to make the instrument dangerous. Intentional interruption is prohibited.</p> <p>Lethal voltages inside the instrument When the instrument is connected to line power, terminals may be live, and opening covers or removing parts is likely to expose live parts.</p>
---	--

WARNING**UV irradiation hazard**

[W9]

An electronic interlock ensures that the instrument lid must be closed for operation of the UV lamp. Under no circumstances should this interlock be disabled.

To ensure satisfactory and safe operation of the QIAgility:

- Connect the line power cord to a line power outlet that has a protective conductor (earth/ground).
- Do not adjust or replace internal parts of the instrument.
- Do not operate the instrument with any covers or parts removed.
- If liquid has spilled inside the instrument, switch off the instrument, disconnect it from the power outlet, and contact QIAGEN Technical Services.

If the instrument becomes electrically unsafe, prevent other personnel from operating it, and contact QIAGEN Technical Services. The instrument may be electrically unsafe when:

- The line power cord appears to be damaged.
- It has been stored for a prolonged period of time in conditions which are outside of the “Storage Conditions”, outlined in Appendix A.
- It has been subjected to severe transport stresses.

1.3 Biological safety

Specimens and reagents containing materials from humans should be treated as potentially infectious. Use safe laboratory procedures as outlined in publications such as Biosafety in Microbiological and Biomedical Laboratories, HHS (www.cdc.gov/od/ohs/biosfty/biosfty.htm).

1.3.1 Samples

Samples may contain infectious agents. You should be aware of the health hazard presented by such agents, and should use, store, and dispose of such samples according to the required safety regulations.

<p>WARNING</p> 	<p>Samples containing infectious agents [W10]</p> <p>Some chemicals used with this instrument may contain infectious agents. Handle such samples with the greatest of care and in accordance with the required safety regulations. Always wear safety glasses, 2 pairs of gloves, and a lab coat.</p> <p>The responsible body (e.g., laboratory manager) must take the necessary precautions to ensure that the surrounding workplace is safe and that the instrument operators are not exposed to hazardous levels of infectious agents as defined in the applicable Material Safety Data Sheets (MSDSs) or OSHA,* ACGIH,[†] or COSHH[‡] documents. Venting for fumes and disposal of wastes must be in accordance with all national, state, and local health and safety regulations and laws.</p>
---	---

*OSHA, [†]ACGIH, [‡]COSHH: See next page.

1.4 Chemicals

<p>WARNING</p> 	<p>Hazardous chemicals [W11]</p> <p>Some chemicals used with this instrument may be hazardous or may become hazardous after completion of the protocol run.</p> <p>Always wear safety glasses, gloves, and a lab coat.</p> <p>The responsible body (e.g., laboratory manager) must take the necessary precautions to ensure that the surrounding workplace is safe and that the instrument operators are not exposed to hazardous levels of toxic substances (chemical or biological) as defined in the applicable Material Safety Data Sheets (MSDSs) or OSHA,* ACGIH,[†] or COSHH[‡] documents.</p> <p>Venting for fumes and disposal of wastes must be in accordance with all national, state, and local health and safety regulations and laws.</p>
---	---

* OSHA: Occupational Safety and Health Administration (United States of America).

[†] ACGIH: American Conference of Government Industrial Hygienists (United States of America).

[‡] COSHH: Control of Substances Hazardous to Health (United Kingdom).

1.4.1 Toxic fumes

If working with volatile solvents or toxic substances, you must provide an efficient laboratory ventilation system to remove vapors that may be produced.



1.5 Waste disposal

Used plasticware and containers may contain certain hazardous chemicals, or contagious/biohazardous materials. Such wastes must be collected and disposed of properly according to local safety regulations.

For information on use and disposal of the tip disposal box, please see Section 3.2.8.

For information about how to dispose of the QIAgility at the end of its economic life, see Appendix A.

1.6 Mechanical Hazards





WARNING 	Moving parts [W12] Avoid contact with moving parts during operation of the QIAgility. Under no circumstances should you place your hands under the pipetting arm when it is lowering. Do not attempt to move any plates or tubes whilst the instrument is operating.
CAUTION 	Damage to the instrument [C3] Do not apply any manual force to the Y-arm (i.e. the pipetting head). We strongly recommend restarting the system if the Y-arm was accidentally manually moved.

To ensure satisfactory and safe operation of the QIAgility:









- Only use recommended tips and tip racks.
- Keep the instrument lid closed whenever possible.
- Do not disable the lid interlock.
- When calibrating plates with the lid open, always stand clear of the instrument when making adjustments. The lid interlock is disabled during calibration mode. Therefore, do not click with the mouse or press any of the keys on the keyboard when looking closely at plate calibrations. Wait until the robotic arm has completed its movements before moving any plates or tubes.
- Do not place any items on the robotic arm.
- Click on the  icon, located on the software toolbar, to pause the instrument before removing plates or tubes from the worktable. Wait until the robotic arm has completed the current movement. This may take up to 10 seconds.

1.7 Maintenance safety



Perform the maintenance as described in Section 8. QIAGEN charges for repairs that are required due to incorrect maintenance.

<p>WARNING/ CAUTION</p> 	<p>Risk of personal injury and material damage [W13] Only perform maintenance that is specifically described in this user manual.</p>
<p>WARNING/ CAUTION</p> 	<p>Risk of electric shock [W14] Do not open any panels on the QIAgility.</p> <p>Risk of personal injury and material damage Only perform maintenance that is specifically described in this user manual.</p>
<p>CAUTION</p> 	<p>Damage to the instrument [C4] Do not use solvents, or reagents containing acids, alkalis, or abrasives to clean the QIAgility.</p>
<p>CAUTION</p> 	<p>Damage to the QIAgility lid [C5] Do not use alcohol, solvents, reagents containing acids, alkalis, or abrasives to clean the instrument lid. Alcohol will damage the lid. To clean the lid, use distilled water only.</p>
<p>CAUTION</p> 	<p>Damage to the QIAgility side panels [C6] Never clean the instrument side panels with alcohol or alcohol-based solutions.</p>

1.8 Symbols on the QIAgility

Symbol	Location	Description
	On the back of the instrument	Warning symbol
	Near the tip chute outlet, and on the front edge of the worktable	Biohazard symbol
	On the front edge of the worktable	Squeezing symbol
	Type plate on the back of the instrument	CE mark for European Conformity
	Type plate on the back of the instrument	CSA listing mark for Canada and the USA
	Type plate on the back of the instrument	Legal manufacturer
	Type plate on the back of the instrument	Waste Electrical and Electronic Equipment (WEEE)
	Type plate on the back of the instrument	FCC mark of the United States Federal Communications Commission

Safety Information

Symbol	Location	Description
	Type plate on the back of the instrument	RCM (former C-Tick) for Australia (supplier identification N17965)
	Type plate on the back of the instrument	RoHS mark for China (the restriction of the use of certain hazardous substances in electrical and electronic equipment).

This page intentionally left blank

2 Introduction

Thank you for choosing the QIAgility. We are confident it will become an integral part of your laboratory.

Before using the QIAgility, it is essential that you read this user manual carefully and pay particular attention to the safety information. The instructions and safety information in the user manual must be followed to ensure safe operation of the instrument and to maintain the instrument in a safe condition.

2.1 About this user manual

This user manual provides information about the QIAgility in the following sections:

1. Safety Information
2. Introduction
3. General Description
4. Installation Procedures
5. QIAgility Software
6. Operating Procedures
7. Instrument Setup and Calibration
8. Preventive Maintenance
9. Troubleshooting
10. Glossary
Appendices
Index

The appendices include the following:

- Technical data
- Warranty terms
- Waste Electrical and Electronic Equipment
- Declaration of conformity
- French (FR) translation of Safety Information
- German (DE) translation of Safety Information
- ABI 7000/7500 SDS Master Mix naming convention
- Advanced settings

- Description of Generic XML Format
- Packing of the QIAgility

Terms used in this manual

The following terms for controlling the mouse are used in this manual.

Left-click	Click with the left mouse button.
Right-click	Click with the right mouse button.
Double-click	Click twice with the left mouse button.
Select "XXX/xxx"	In the toolbar, select the "xxx" submenu from the "XXX" menu. Examples are "File/Exit" and "Options/New".

2.2 General information

2.2.1 Technical assistance

At QIAGEN we pride ourselves on the quality and availability of our technical support. Our Technical Services Departments are staffed by experienced scientists with extensive practical and theoretical expertise in sample and assay technologies and the use of QIAGEN products. If you have any questions or experience any difficulties regarding the QIAgility or QIAGEN products in general, do not hesitate to contact us.

QIAGEN customers are a major source of information regarding advanced or specialized uses of our products. This information is helpful to other scientists as well as to the researchers at QIAGEN. We therefore encourage you to contact us if you have any suggestions about product performance or new applications and techniques.

For technical assistance and more information, please see our Technical Support Center at www.qiagen.com/goto/TechSupportCenter or call one of the QIAGEN Technical Service Departments or local distributors (see back cover or visit www.qiagen.com).

2.2.2 Policy statement

It is the policy of QIAGEN to improve products as new techniques and components become available. QIAGEN reserves the right to change specifications at any time.

In an effort to produce useful and appropriate documentation, we appreciate your comments on this user manual. Please contact QIAGEN Technical Services.

2.2.3 Version management

This document is the *QIAgility User Manual*, version 4.18.

2.3 Intended use of the QIAgility

The QIAgility is designed to perform automated PCR setup and liquid handling actions in molecular biology applications.

If used in combination with QIAGEN kits indicated for use with the QIAgility, the instrument is intended for the applications described in the respective QIAGEN kit handbooks.

If the QIAgility is used with other than QIAGEN kits, it is the user's responsibility to validate the performance of the product combination for any particular application.

The QIAgility is intended for use by professional users trained in molecular biological techniques and the operation of the QIAgility.

2.3.1 Requirements for QIAgility users

This table covers the general level of competence and training necessary for transportation, installation, use, maintenance, and servicing of the QIAgility.

Task	Personnel	Training and experience
Delivery	No special requirements	No special requirements
Installation	Laboratory technicians or equivalent	Appropriately trained and experienced personnel familiar with use of computers and automation in general
Routine use (running methods)	Laboratory technicians or equivalent	Appropriately trained and experienced personnel familiar with use of computers and automation in general
Servicing and annual preventive maintenance	QIAGEN Field Service Specialists only	Regularly trained, certified, and authorized by QIAGEN

3 General Description

The QIAgility System performs fully automated PCR setup. The QIAgility System comprises the QIAgility, a computer, and QIAgility Software. These components have been optimized to work together across a wide variety of applications and provide unmatched accuracy, precision, and speed for PCR setup. The instrument configuration is with HEPA filter/and UV lamp.

3.1 QIAgility principle

The QIAgility uses a single-channel pipet to automate PCR setup — up to 96 PCR reactions can be set up in approximately 30 minutes. Level sensing, facilitated by conductive tips, enables high-precision pipetting.

1. The QIAgility worktable is set up with a Master Mix Block, a Reagent Block, tips and plates/tubes. The instrument is then calibrated.
Note: Tubes are placed into plates and are therefore treated as plates in the software.
2. Run files are created and modified using the easy-to-use QIAgility software. The user can download Q Protocols from www.qiagen/goto/QIAgility and modify them according to their needs. Wizards are also available to guide the user step by step through developing new run files.
3. The progress of a run can be followed in real-time. The software highlights the position of the pipetting head on the screen as it moves.
4. The QIAgility supports virtually all plate formats, including Rotor-Discs for the Rotor-Gene[®] Q, therefore PCR reactions can be analyzed immediately using any PCR cyclers.

3.2 The QIAgility

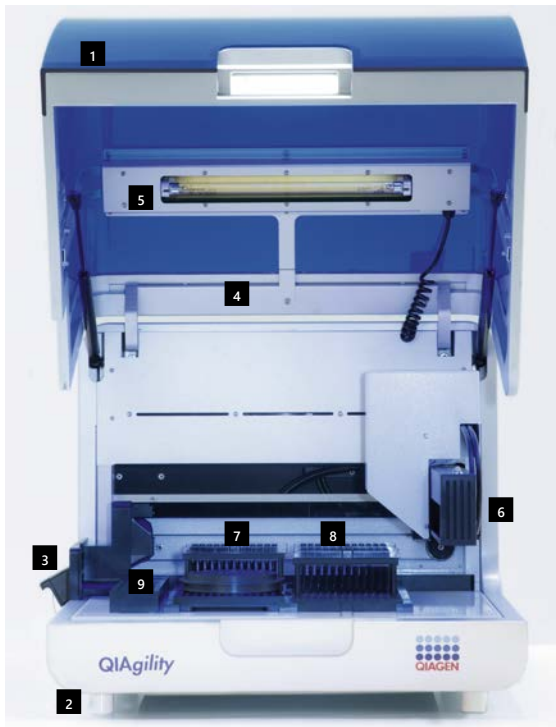

- | | | | |
|----------|-------------|----------|---------------------------------------|
| 1 | Lid | 6 | Pipetting head
(Robotic arm) |
| 2 | Feet | 7 | Tip Rack Holder
and tips |
| 3 | Tip chute | 8 | Tip Rack Holder
and tips |
| 4 | HEPA filter | 9 | Master Mix Block
and Reagent Block |
| 5 | UV lamp | | |

3.2.1 Instrument lid (1)

CAUTION 	Damage to the QIAgility lid [C5] Do not use alcohol, solvents, reagents containing acids, alkalis, or abrasives to clean the instrument lid. For more information, see Section 8.1.1.
---	--

The lid of the instrument provides both an isolated enclosure for performing purification and a safety mechanism.

The instrument lid incorporates a magnetic sensor to determine whether the lid is closed or not. Under no circumstances should this sensor be bypassed.

The instrument lid must be closed for the software and hardware to initialize upon start-up and for a run to proceed.

Opening the instrument lid while the robotic arm is performing a run will cause the robotic arm to pause.

Extreme care should always be taken when opening the instrument lid during a run as the pause in robotic operation may take several seconds to be completed.

The instrument lid may remain open when calibrating the position and height of plates. Do not interfere with robotic arm movement during these calibrations and keep all body parts out of reach of the robotic arm while it is moving.

Important: Care should be taken when opening the lid during a run because it takes up to 10 seconds for the instrument to complete the current movement and for the pause to take effect. Under no circumstances should this sensor be bypassed.

3.2.2 Feet (2)

The feet of the instrument have a non-slip silicone base to ensure that the QIAgility remains securely positioned on a laboratory bench. Do not attempt to slide the instrument on

a bench. Always lift the instrument to avoid damage to the silicone base of the feet.

3.2.3 Tip chute (3)

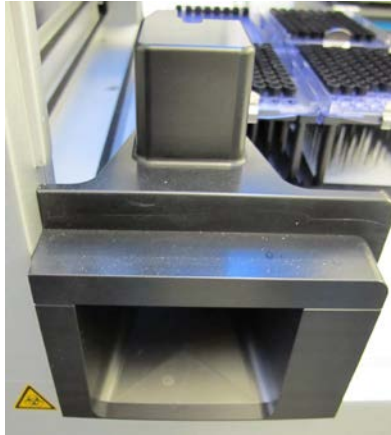

Tip chute.

Tips used on the worktable are discarded through the tip chute. Located at the left hand side of the QIAgility, the tip chute is held in place by a locating block, allowing easy placement and removal for cleaning.

Note: Details on removing and replacing the tip chute/tip ejector chute are described in Section 8.2.2.

3.2.4 HEPA filter (4)

The HEPA filter system provides positive clean air pressure on the worktable beneath the hood. The HEPA filter system consists of two HEPA filter cartridges.



HEPA filter.

3.2.5 UV lamp (5)

A UV lamp in the instrument lid provides efficient worktable decontamination and helps to prevent cross-contamination.

Note: Before using the UV lamp the tip chute must be placed into the instrument.

To operate the UV lamp:

1. Make sure that the UV lamp bulb is connected to the UV plug.
2. Make sure that the QIAgility instrument lid is securely closed.

For increased safety, an electronic interlock ensures that the UV lamp operates only when the instrument lid is closed. Under no circumstances should the interlock be disabled.

During UV irradiation, the robotic arm moves between 2 locations at 5 second intervals. All items must be removed from the instrument to ensure the worktable is fully exposed.

The UV lamp does not irradiate certain areas, including the pipetting head, due to construction constraints.

The UV lamp is enabled and time of exposure is set within the QIAgility Software. For more details, see Section 6.2.

3.2.6 Pipetting head (6) and robotic arm

Liquid-handling tasks are performed by the pipetting head, which provides a motor-driven, backlash-compensated pipetting mechanism. Tips attach to the pipettor barrel of the pipetting head.

The robotic arm controls the movement of the pipetting head in the X-, Y-, and Z-directions.

The Y-axis arm of the robotic arm provides support for the pipetting head. Under no circumstances should the user apply any force to the Y-arm. This may misalign the arm and cause pipetting errors.

Note: To prevent accidental damage, the wooden Y-arm support should always be fixed or locked before the QIAgility is moved.

3.2.7 Worktable

The worktable is the instrument surface upon which items, such as plates, reagents, and tips are placed.

Worktable layout is specified for a protocol with a run file and is represented in the QIAgility Software as the workspace. For more details, see Section 5.3.4.

3.2.8 Tip disposal box

Discarded tips are collected in a tip disposal box, located at the side of the QIAgility.

Each tip disposal box holds approximately 350 used tips.

Use of the tip disposal box is optional. Alternative boxes can be used at the user's discretion and may better suit the individual situation. For example, positioning the instrument close to the left edge of a laboratory bench or table allows tips to be ejected from the instrument directly into a biohazard waste bin or bag.

3.2.9 Accessory panel

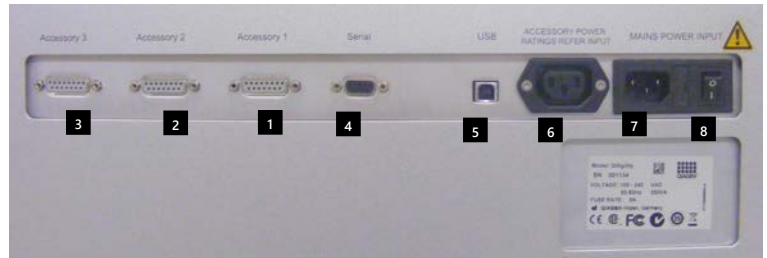

QIAgility accessory panel.

- | | | | |
|----------|----------------------|----------|-------------------------|
| 1 | Accessory 1 | 5 | USB socket |
| 2 | Accessory 2 | 6 | Accessory power outlet |
| 3 | Accessory 3 | 7 | Main power input socket |
| 4 | Serial RS-232 socket | 8 | Power switch |

3.2.10 Internal features of the QIAgility

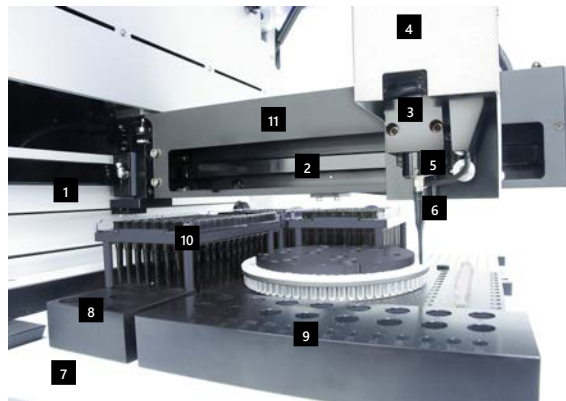
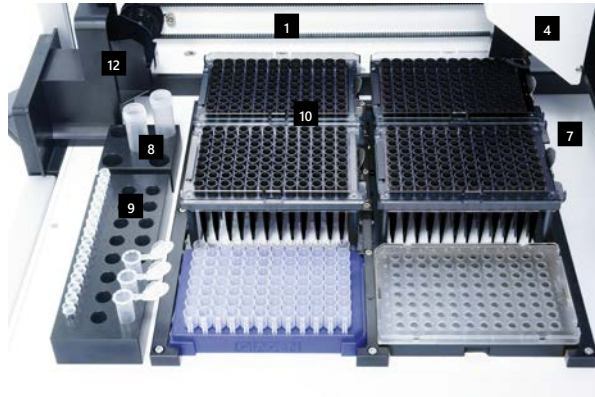

- | | | | |
|---|----------------------|----|---------------------------|
| 1 | X-axis | 7 | Worktable |
| 2 | Y-axis | 8 | Master Mix Block |
| 3 | Z-axis | 9 | Reagent Block |
| 4 | Pipetting head cover | 10 | Tip Rack Holders and tips |
| 5 | Pipetting head | 11 | Y-arm |
| 6 | Pipetting hub | 12 | Tip ejector |

X-axis

The X-axis directs the left/right movement of the pipetting head.

Y-axis

The Y-axis directs the forwards/backwards movement of the pipetting head.

Z-axis

The Z-axis directs the upwards/downwards movement of the pipetting head.

Tip ejector

The tip ejector facilitates tip removal from the pipetting head.

Pipetting head cover and pipetting head

The pipetting head is located under the protective pipetting head cover. The pipetting head consists of a motor driven backlash-compensated pipetting mechanism. This mechanism is similar to most hand pipets.

Y-arm

The Y-arm supports the pipetting head. Under no circumstances should the user apply force to the Y-arm. This may misalign the Y-arm and cause pipetting errors.

Worktable

The worktable has 6 SBS positions (127.76 mm x 85.48 mm) in which Tip Rack Holders and plates are located. In addition, the worktable supports the Master Mix Block and Reagent Block. The silver paint is epoxy paint which is hard wearing and UV resistant.

Master Mix Block

The master mix block is intended to hold diluent and master mix on the worktable. The QIAgility is supplied with 2 Master Mix Blocks which can hold:

- 5 x 5 ml free-standing tubes
- 1 x 5 ml free-standing tubes, and 4 x 1.5 ml tapered tubes



Reagent Block

The Reagent Block is intended to hold reagents and standards on the worktable. The Reagent Block can hold 8 x 1.5 ml tapered tubes, 8 x 2 ml free-standing tubes, and 16 x 200 μ l PCR tubes.



Adapters

The QIAgility is supplied with 3 SBS adapters:

- 2 x Adapter, 96 x 0.2 ml PCR Tubes
- 1 x Adapter, Flip-Cap 32 x 1.5 ml Tapered Base

The 96-well adapters are intended to hold strip tubes and unskirted and half-skirted PCR plates.



The 32-well adapter enables caps to be locked in position, preventing interference with the pipet tip.



Sample tubes

A range of tube types can be used with the QIAgility. The following sample tubes are supplied with the instrument:

- 5 ml free-standing tubes
- 200 μ l PCR tubes

Note: Supplied sample tubes are not guaranteed to be sterile.

Free-standing tubes (5 ml) are typically used to hold diluent and large volumes of master mix. These tubes are normally supported in the Master Mix Block.

PCR tubes (200 μ l) are typically used to hold samples and reactions, and are normally supported by the 96-well adapters.

Important: Tubes supplied by different manufacturers may have slightly different dimensions, despite a similar appearance. Such differences can significantly affect the calibration settings, in particular the plate height calibration. We recommend that once a particular tube type is chosen, the user always purchases that consumable from the same manufacturer to avoid frequent recalibration.

Conductive Filtered Tips and Tip Rack Holders

Tip Rack Holders can hold 200 μl or 50 μl Conductive Filtered Tips on the worktable. Supplied tips are carbon impregnated. See Section 6.4.4 for details about how to insert tips into a Tip Rack Holder.



3.3 Liquid-level tracking

The QIAgility can track the liquid level using 1 of 2 methods: liquid-level sensing or liquid-level estimate.

Liquid-level sensing

For maximum accuracy and precision, the QIAgility is equipped with a liquid-level sensor. This feature enables the instrument to automatically detect when the pipet tip makes contact with the liquid as the tip descends. When aspirating, the tip is placed below the liquid surface, at the minimum insertion depth required to collect the aspirate volume. When dispensing, the tip is placed at the liquid surface and retracted as liquid is ejected. This minimizes contact between the tip and the liquid, reducing liquid carry-over.

The liquid-level sensor relies on conductive tips to detect the change in capacitance when the tip contacts the liquid inside a tube — the smaller the volume of liquid inside the tube, the lower the change in capacitance. For correct functioning of the liquid-level sensor, it is essential that the plates that are physically located on the instrument worktable are correctly assigned in the software. See Section 5.7 for details about how to do this.

If a liquid is nonconductive (e.g., pure water, oil), the level sensor will not detect any change in capacitance.

Note: Addition of low concentrations of conductive substances (e.g., salts) to nonconductive liquids may enable liquid-level sensing to be used.

Note: To pipet from wells that contain less liquid than the level sensor limit, it is necessary to switch the level sensor off, or reset the error detection levels. It may also be necessary to manually calibrate the plate height closer to the base of the tube. Alternatively, the liquid-level estimate mode can be used.

Liquid-level estimate

This feature enables the instrument to estimate the liquid level, using information from the run configuration. The software tracks the movement of liquid between wells and estimates the liquid level during all liquid transfers. This information is used to determine the optimal tip placement. Levels of accuracy and precision comparable to those obtained with liquid-level sensing are obtained. The pipet tip moves to a calculated position so that, after aspiration, the pipet tip remains below the liquid level.

3.4 Computer

The QIAgility is operated via a computer.

A laptop with the correct specification for operation of the QIAgility and QIAgility Software is supplied as part of the QIAgility System. However, if a different computer is used to operate the QIAgility or to run the QIAgility Software, then the following laptop hosting systems are recommended.

Laptop specifications:

- Windows 10 (64-bit) with minimum required version 1607
- At least 2.5 GHz CPU
- At least 4 GB RAM
- DVD/CD-ROM
- Minimum 80 GB free hard drive capacity
- At least 1360 x 768 screen resolution
- Pointer device (mouse or similar)

The computer connects to the QIAgility by the USB **Note:** The software is tested by QIAGEN using the original image supplied with your laptop without connecting the laptop to the internet. Updates on your operating system might lead to unexpected behavior of the QIAgility software.

Note: Some virus protection software might interfere with QIAgility Software and cause the software to run very slowly

This page intentionally left blank

4 Installation Procedures

This section provides instructions on unpacking and installing the QIAgility.

Note: For your own safety and to prevent damage to the instrument, observe the safety instructions.

4.1 Instrument delivery and installation

The following items are delivered:

- QIAgility instrument
- Laptop
- QIAgility Software and User Manual on CD
- Accessories

Note: We recommend checking the packing list before installation.

4.2 Requirements

Site

Choose the position for the QIAgility carefully. A change in position necessitates a recalibration. Place the QIAgility in its final position.

The requirements for the QIAgility location and position are given below:

- The QIAgility must be located out of direct sunlight, away from heat sources, and away from sources of vibration and electrical interference. Refer to Appendix A for the operating conditions (temperature and humidity).
- The site of installation should be free of excessive drafts, excessive moisture, excessive dust, and should not be subject to large temperature fluctuations.
- Use a level workbench that is dry, clean, vibration-proof, and large enough to accommodate the QIAgility, computer, and tip disposal box. Refer to Appendix A for the weight and dimensions of the QIAgility.



Installation Procedures

- The QIAgility must be placed within approximately 1.5 m of a properly grounded (earthed) AC power outlet. The power line to the instrument should be voltage regulated and surge protected.
- Ensure that the switch and the main power input socket at the rear of the instrument are easily reachable. Maintain sufficient clearance at the rear to unplug the power line from the main power input socket.
- Ensure that the instrument lid can fully open upwards without obstruction.
- The QIAgility must not be installed near generators of static electricity (e.g., ionizers, large-screen televisions).
- The QIAgility should be installed in a laboratory environment that is free of excessive airborne dust.

Note: We recommend that the QIAgility does not share a wall socket with other laboratory equipment, and that the QIAgility is plugged directly into its own wall socket.

Important: The wall socket should be easily accessible.

Important: Position the QIAgility in a way that allows easy access to the power supply cable at the rear. Meeting these location and position requirements will allow you to immediately disconnect the instrument from the power supply should a need or emergency arise.

<p>WARNING/ CAUTION</p> 	<p>Risk of overheating [W2]</p> <p>To ensure proper ventilation, maintain a minimum clearance of 10 cm at the sides and rear of the QIAgility. Slits and openings that ensure the ventilation of the QIAgility must not be covered.</p>
<p>CAUTION</p> 	<p>Damage to the instrument [C1]</p> <p>Direct sunlight may bleach parts of the instrument and cause damage to plastic parts. The QIAgility must be located out of direct sunlight.</p>

Laptop

For operation of the QIAgility, the supplied laptop must be connected and placed near to the instrument.

4.3 AC power connection

Power requirements

The QIAgility operates at:

- 100–240 V, 250 VA, 50–60 Hz, 5 A fuse

Make sure the voltage rating of the QIAgility and laptop are compatible with the AC voltage available at the installation site. Main supply voltage fluctuations must not exceed 10% of nominal supply voltages.

Grounding requirements

To protect operating personnel, and for correct functioning of the liquid-level sensor, QIAGEN recommends that the QIAgility is correctly grounded (earthed). The instrument is equipped with a 3-conductor AC power cord that, when connected to an appropriate AC power outlet, grounds (earths) the instrument. To preserve this protection feature, do not operate the instrument from an AC power outlet that has no ground (earth) connection.

4.4 Unpacking the QIAgility

Before unpacking the QIAgility, move the package to the site of installation and check that the arrows on the package point upwards. In addition, check whether the package is damaged. In case of damage, contact the transporter of the package.

See the underside of the lid of the box for a guide to removing the QIAgility from the box.

When lifting up the QIAgility, slide your fingers under both sides of the instrument and keep your back straight.

<p>WARNING/ CAUTION</p> 	<p>Risk of personal injury and material damage [W3]</p> <p>The QIAgility is too heavy to be lifted by one person. To avoid personal injury or damage to the instrument, do not lift the instrument alone.</p>
--	---

After unpacking the QIAgility, check that the following documents are supplied:

- Packing list
- QIAgility Software CD
- Factory volume calibration report

Read the packing list to check that you have received all items. If anything is missing, contact QIAGEN Technical Services.

Check that the QIAgility is not damaged and that there are no loose parts. If anything is damaged, contact QIAGEN Technical Services. Make sure that the QIAgility has equilibrated to ambient temperature before operating it.

Retain the packaging in case you need to transport or ship the QIAgility in the future. Instructions for packing the QIAgility are outlined in Appendix H. Using the original package minimizes damage during transportation of the QIAgility.

Carefully place the QIAgility onto the workbench where it will be used. For site requirements please refer to Section 4.2.

4.5 Installing the QIAgility

Releasing the transport locks

Note: The procedure for removing the transport locks is also written on the transport locks on the instrument.

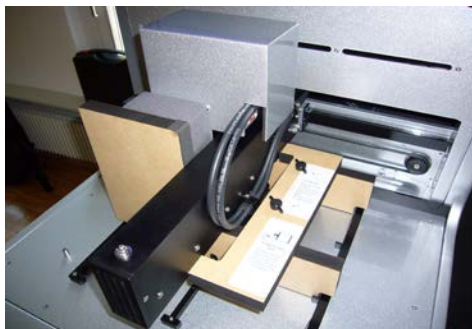

1. Unscrew the two screws (1 and 2) and remove the horizontal bar.

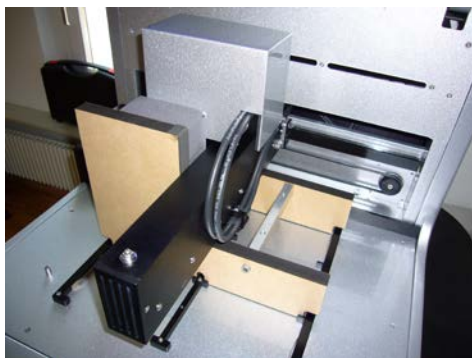

2. Move the pipetting head to the right and remove the transport lock from the worktable.

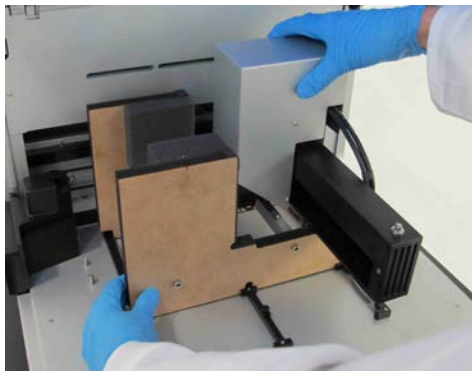
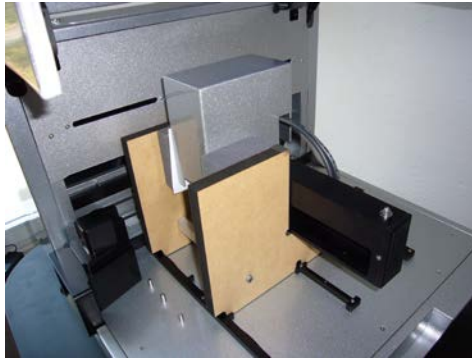

3. Unscrew the Z-axis locking screw. When this screw is removed, the pipetting head will drop.

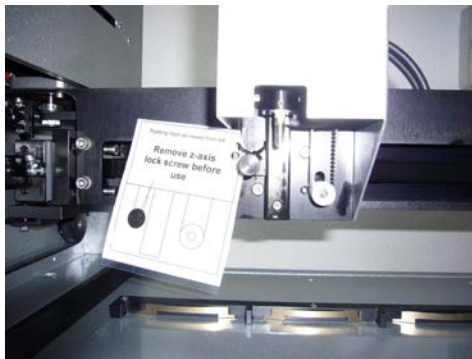

4. Store the transport lock and the Z-axis screw with the rest of the packaging.

4.5.1 UV lamp

The UV plug is integrated within the lid. To connect the UV lamp proceed as follows:

1. Open the lid.
2. Connect the delivered UV lamp bulb into the UV plug.

Note: Hold the UV lamp bulb at both ends when fixing into the UV plug. Always wear safety gloves.

WARNING 	UV irradiation hazard [W9] An electronic interlock ensures that the instrument lid must be closed for operation of the UV lamp. Under no circumstances should this interlock be disabled.
---	--

4.5.2 HEPA filter system

The HEPA filter system is installed and connected before shipping.

Note: Instructions for exchanging the HEPA filter system are given in Section 8.2.3.

4.5.3 Instrument calibration

Before the instrument is used, some calibrations are required: position and height calibrations, tip offset calibration, and volume calibration. Please refer to Sections 7.1.2 to 7.1.6 for detailed descriptions.

4.5.4 Computer setup and installation of software

For computer system requirements, please see Section 3.4.

1. Set up the computer as described in the computer installation instructions provided with the computer.
2. Before installing the QIAgility Software, shut down all other software and make sure that the instrument is not connected to the computer.
3. Install the QIAgility Software. See Section 4.6 for detailed information about how to install the software.
Note: Some virus protection software is known to interfere with QIAgility Software and will cause the software to run very slowly.

4.6 Software installation

Install the QIAgility Software as follows:

1. Insert the QIAgility Software CD into the CD-ROM of the computer.
2. The installer splash screen will be displayed after a few seconds. If the splash screen is not automatically displayed, click on "Start Menu", select "Run" and then enter "CD/DVD-ROM drive":\setup.exe (e.g., d:\setup.exe).
3. Select "Install Operating Software" on the splash screen. This will initiate the installation process.
4. If you are using Windows 10, the user account control (UAC) will appear.
5. Click "Yes" to continue.
6. The "QIAgility Setup Wizard" will appear. This wizard will guide you through the installation. Instructions are displayed on each screen of the wizard.
Note: We recommend using the default settings for all screens.

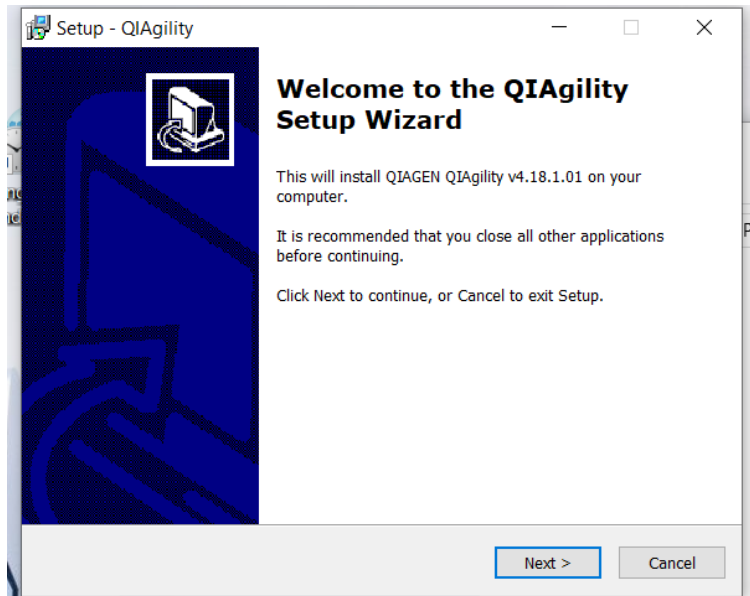

7. Click on the "Next" button to continue with the installation process. The "License Agreement" screen will appear.

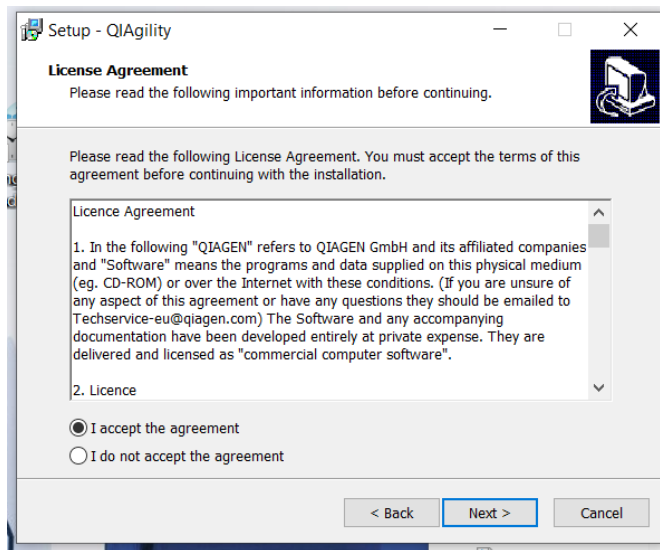

- Accept the terms of agreement and click the “Next” button to continue.

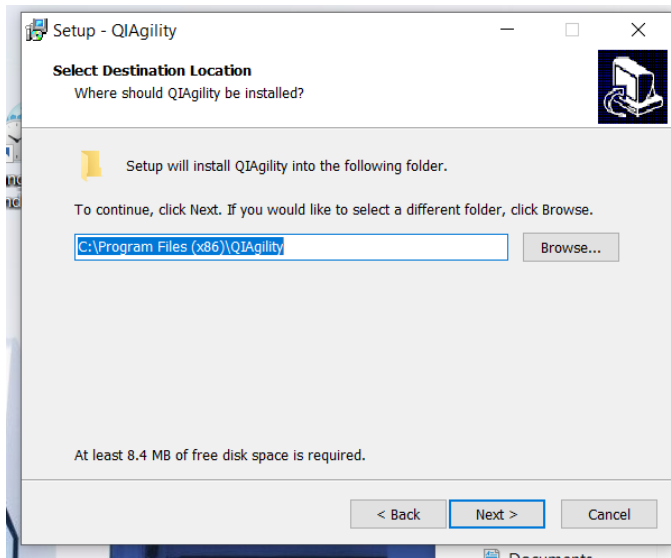

- To install the software under the default path, click the “Next” button. To install the software under a different directory, browse for the directory and then click on the “Next” button.

Note: If a previous software version is already installed, the “Select Destination Location” screen will not appear. The following message box will appear instead.

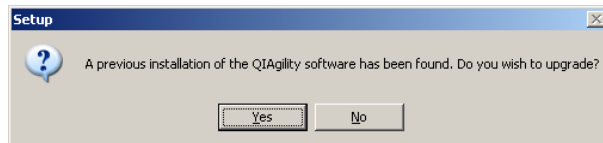

- To uninstall a previous software version, click on the “Yes” button. The calibration settings and run files will be retained. To maintain the previous version of the software, click on the “No” button and browse for a different installation directory. Click on the “Next” button to continue.

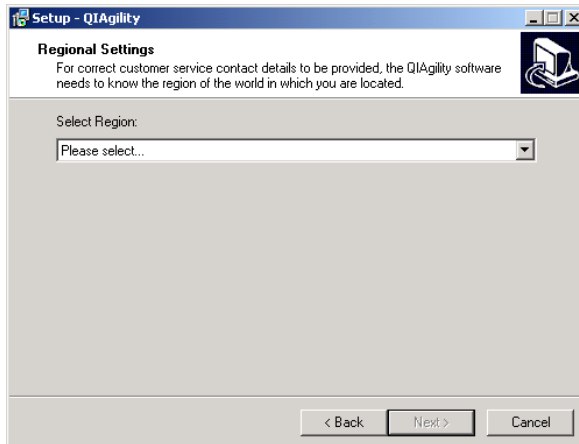

11. Use the drop-down menu to select your region. Click on the "Next" button to continue.

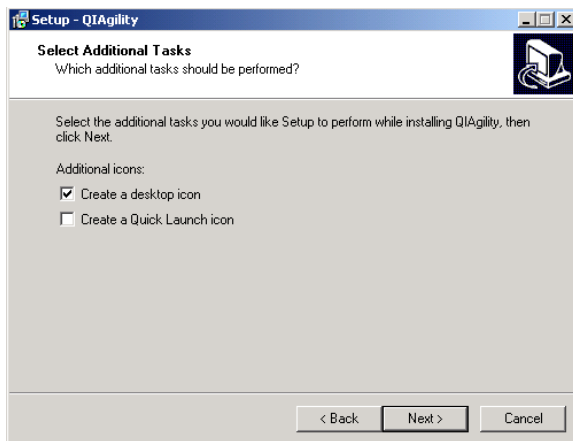

12. Select the additional tasks and then click on the "Next" button. Select "Create a desktop icon" to create a desktop icon to easily launch the software. Select "Create a Quick Launch" icon to generate a quick launch icon.

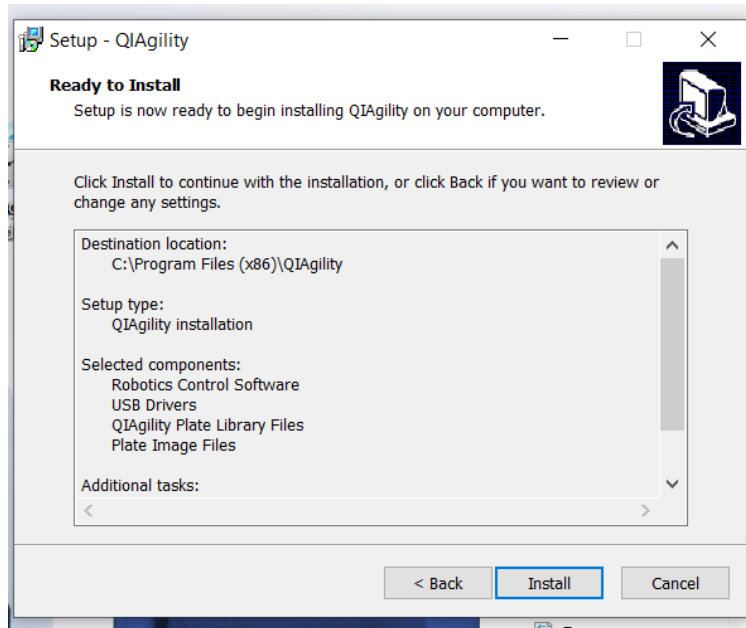

13. Review the displayed details. Click on the “Install” button.

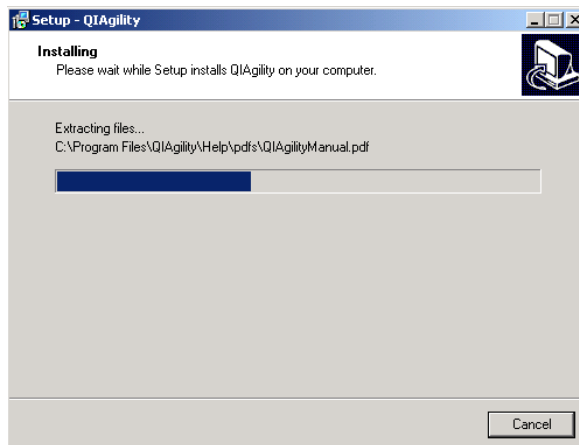

14. The QIAgility Software will now be installed onto your computer. This could take a few minutes.
15. If you are using Windows 10, the following message will appear.

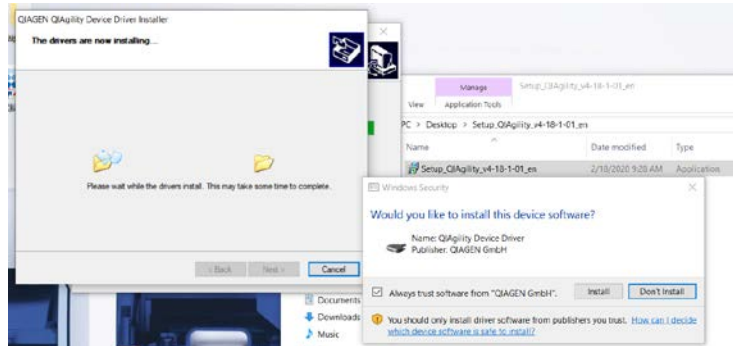

For correct installation of USB drivers, click on the "Finish" button.



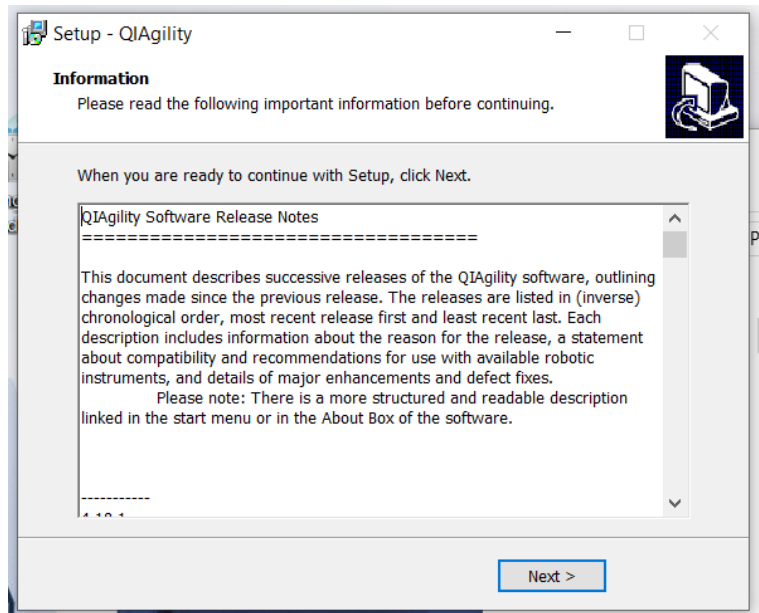

16. Review the displayed information, and then click on the "Next" button to continue with the software installation.

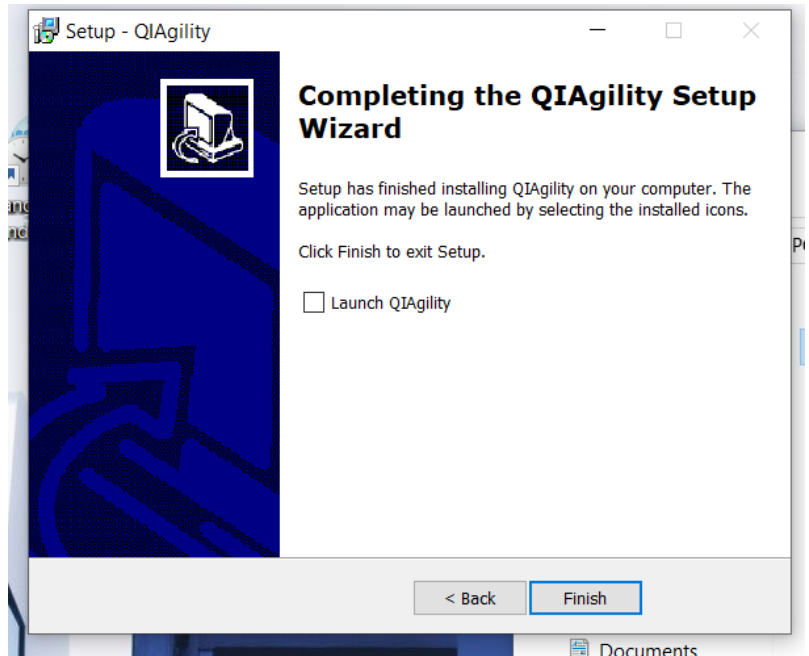

17. To directly launch the QIAgility Software, select "Launch QIAgility" and then click on the "Finish" button. If you do not want to launch the QIAgility software immediately, click on the "Finish" button to complete the installation process.

4.6.1 Uninstalling QIAgility software

Two methods can be used to uninstall the software. The recommended method is to uninstall the software via the "Settings" menu.

To uninstall the software via the "Settings" menu:

1. Select "Start/Settings/Control Panel". The "Control Panel" window will open.
2. Double-click on the "Add or Remove Programs" icon.
3. Select "QIAgility" from the list of installed programs and then click on the "Remove" button.

To uninstall the software via the "Programs" menu:

1. Select "Start/Programs/QIAgility/Uninstall".

- Click on the “Yes” button to continue.
Note: When the software is uninstalled, calibration settings, run settings and run files will not be deleted.

4.7 Folders

When the software is installed, a number of folders and subfolders are created.

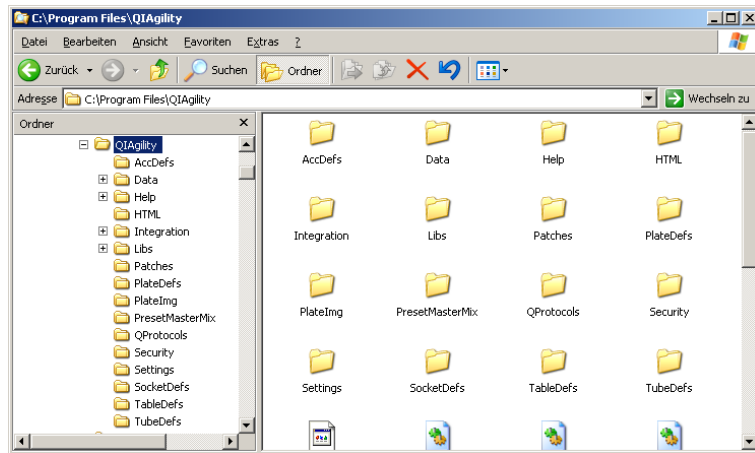

Data	Run files are saved in this folder.
Data — Logs	Log files are saved in this subfolder.
Data — Reports	Pre-run and post-run reports are saved in this subfolder.
Data — SupportPackages	Diagnostic support packages are saved in this folder.
Help	Contains a PDF of the <i>QIAgility User Manual, version 4.18</i> .
HTML	Contains a HTML version of the release notes.

Integration	Contains XSL transformation files for custom export
QProtocols	Q Protocols are stored in this folder; see Sections 4.7.1 and 6.4.1 for more details about this folder.

In addition, these folders are important for operating the instrument:

- AccDefs
- Libs
- Patches
- PlateDefs
- PlateImg
- PresetMasterMix
- Security
- Settings
- SocketDefs
- TableDefs
- TubeDefs

Note: Do not attempt to modify or delete these folders.

4.7.1 “QProtocols” folder

Storing Q Protocols in this folder enables access to the “Protocols” tab in the splash screen that opens when the software starts, and also after clicking on the  icon.

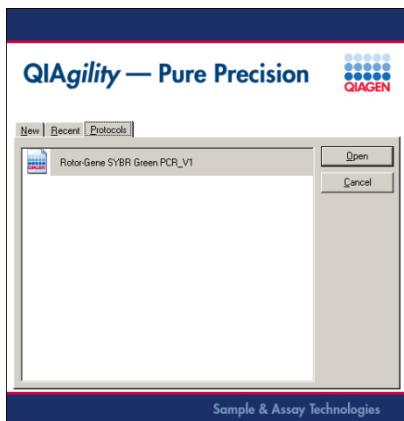

Note: If no Q Protocols are present in the “QProtocols” folder, the “Protocols” tab will not be available. If a specific Q Protocol is not saved in the “QProtocols” folder, it will not be listed when the “Protocols” tab is selected.

4.7.2 Connecting the computer to the QIAgility

Note: Before connecting the QIAgility to the computer for the first time, ensure that the QIAgility Software has been installed (see Section 4.5.4).

The QIAgility has the interface connection to the computer USB. The laptop which is supplied with the QIAgility should be installed USB interface can be used, depending on the configuration of the computer, **Note:** Connect the computer to the QIAgility only via the USB interface. Do not use the RS-232 with Win 10.

To connect via the USB interface:

- Connect the USB cable between the USB port on the instrument and the USB port on the computer.

4.7.3 COM port configuration

The COM port used to connect the computer to the QIAgility must be correctly configured in the software to enable the software to communicate with the QIAgility instrument.

Note: This COM port number might change depending on the use of other virtual COM ports on your computer. QIAgility software will mark the correct virtual COM port number with an asterisk (*). You can check the COM port number in the hardware manager of your computer.

4.7.4 Installation of AC power cord

Important: The QIAgility Software must be installed on the computer before the QIAgility is switched on (see Section 4.5.4).

Connect the QIAgility to the power outlet as follows:

1. Ensure that the power switch of the QIAgility is set to the off position.
2. Check that the voltage rating on the label at the back of the QIAgility matches the voltage available at the installation site.
3. Plug the power cord into the main power input socket.
4. Plug the power cord into a grounded power outlet.
Important: The wall socket should be easily accessible.
5. If the QIAgility Software has been installed on the computer, you can switch the instrument.

4.8 Hardware Wizard



1. Select "No, not this time", and then click on the "Next" button.

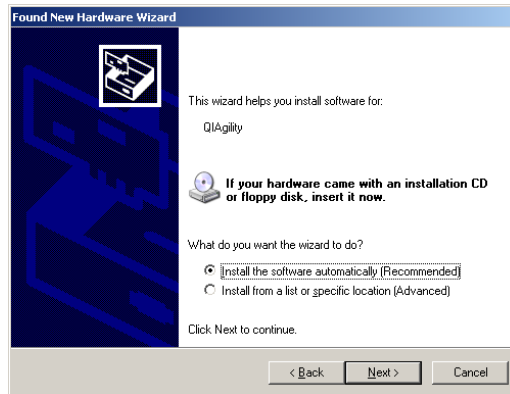

2. We recommend that you select "Install the software automatically".
3. Click on the "Next" button to continue.



4. Click on the "Continue Anyway" button.

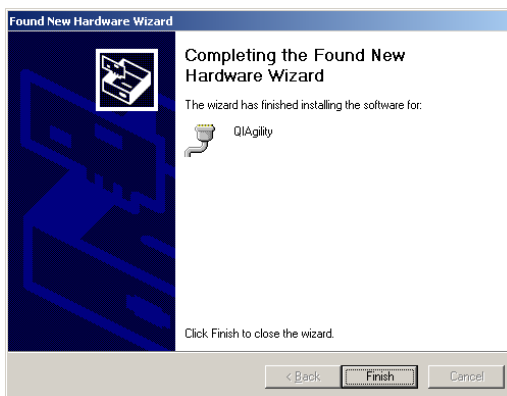

5. Click on the “Finish” button.
The QIAgility Software and instrument have now been successfully installed.

4.9 Setting up the QIAgility

Note: If the “Hardware Wizard” appears when the computer is switched on, see Section 4.8 for more details.

1. Ensure that the instrument lid is closed.
2. Set the power switch of the QIAgility to the on position and switch the computer on. The pipetting head should move upwards. If this does not happen, please consult the Troubleshooting section of this user manual.
3. Double-click on the  icon on the desktop. This launches the QIAgility Software. Alternatively, select “Start/Programs/QIAgility/QIAgility”.

Note: If the instrument is not switched on, the software will be operated in “Virtual Mode”. For more information, see Section 5.2.

4. The following welcome screen will appear. Select the “New” tab.

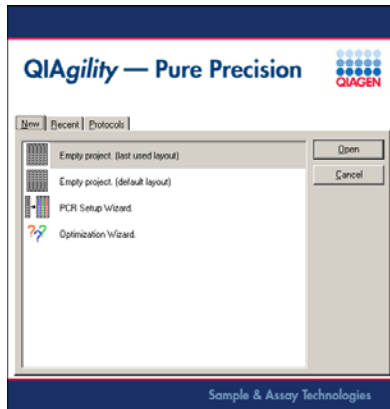

5. Select “Empty Project (last used layout)” or “Empty Project (default layout)” and then click the “Open” button. Alternatively, double-click “Empty Project (last used layout)” or “Empty Project (default layout)”.
6. The following message appears.

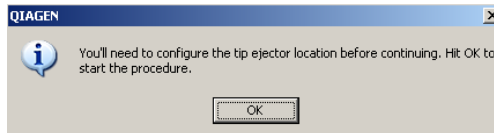

7. Click on the “OK” button to proceed to tip ejector calibration. See Section 7.1.1 for more details about how to do this.
Note: Tip ejector calibration must be performed before any other calibrations.
8. Perform the remaining calibrations in the order listed in Sections 7.1.2 to 7.1.6.

This page intentionally left blank

5 QIAgility Software

The easy-to-use QIAgility Software has been specially developed for use with the QIAgility instrument. The software simulates the instrument worktable and enables the user to follow the progress of a run in real time, by highlighting the position of the pipetting head on the worktable. The software can also be run in “Virtual Mode”, which enables run files to be simulated before use in “Normal Mode”. This allows fast, step-by-step setup of new run files, which can be tailored to the needs of the user.

The QIAgility Software is supplied without protocols. Q Protocols can be downloaded from www.qiagen.com/goto/QIAgility. Select the “User Support” tab and look under the “Protocols” header. For convenience, the software automatically calculates the required volume of each of the starting liquids (e.g., master mix and samples). In addition, the software generates pre-run and post-run reports.

5.1 Starting the software

Note: Before starting the QIAgility Software, ensure that the instrument lid is closed and that the instrument is switched on.

1. Double-click on the  icon on the desktop, or select “Start/Programs/QIAgility/QIAgility”. If the instrument is switched on, and is connected to the computer, the software will proceed automatically to “Normal Mode” operation. If the instrument is not connected to the computer, or if the instrument is switched off, the software will operate in “Virtual Mode”.

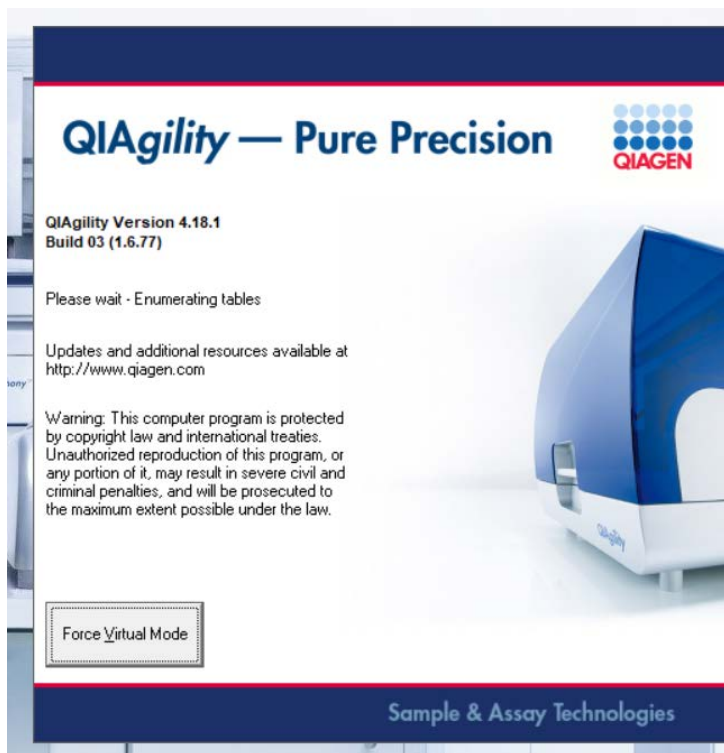

2. To force "Virtual Mode" operation, click on the "Force Virtual Mode" button. See Section 5.2 for more detailed information about "Virtual Mode" operation.

5.2 Virtual Mode

"Virtual Mode" enables run files to be developed and simulated, without actually performing the pipetting operations on the instrument. This is particularly useful for checking new run files. In "Virtual Mode" all software functions are enabled. Run files which are developed in "Virtual Mode" can be saved and then run in "Normal Mode".

Note: Any modifications made to calibrations in "Virtual Mode" will not affect calibrations on the actual instrument.

When the instrument is running in “Virtual Mode”, the following message will be displayed at the top of the main software window, indicating that the software is running in “Virtual Mode”.



5.3 Main software window

The main software window provides an interface for the creation of run files. The main features are as follows:

- Menu bar
- Toolbar
- Mode indicator
- Software workspace

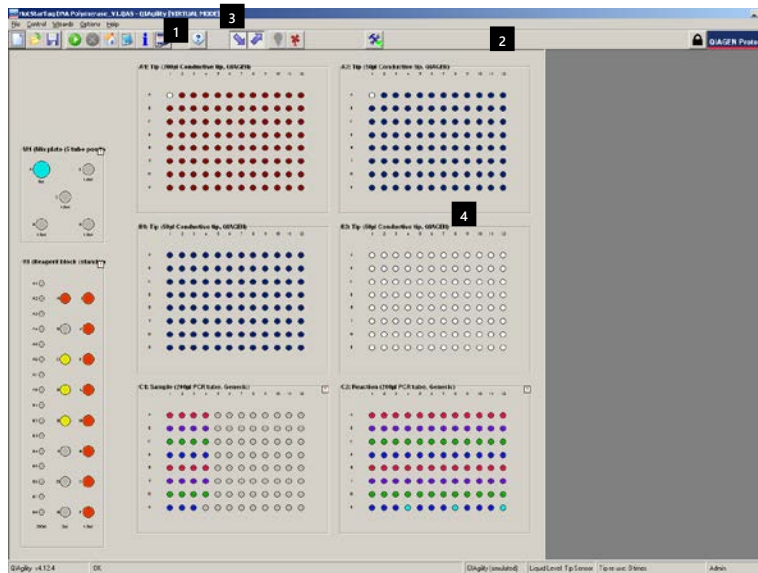

1 Menu bar

3 Mode indicator

2 Toolbar

4 Software workspace

5.3.1 Menu bar

The menu bar contains 5 menus – “File”, “Control”, “Wizards”, “Options”, and “Help”. All software functions can be controlled from these menus. This section outlines the options that are available from these menus.

In addition, when the right-hand pane is open, the following icon is available from the menu bar. See Section 5.3.4 for more details about the options that are available from this icon.



Right-hand pane icon

“File” menu

The “File” menu provides access to file related functions.

File	Control	Wizards	Options	Help
New				Ctrl+N
Open...				Ctrl+O
Save As...				Ctrl+S
Lab notebook...				
Protocol description...				
Unlock protocol...				
1 HotStarTaq1_signed3.QAS				
2 HotStarTaq1_signed3__2008-11-20_10-11-55.QAS				
3 HotStarTaq1_signed3.QAS				
4 HotStarTaq1_signed3__2008-11-19_13-01-26.QAS				
5 HotStarTaq1_signed3__2008-11-19_09-03-08.QAS				
6 HotStarTaq1.QAS				
7 Quantifast MP-PCR-2-GD.QAS				
8 RT-PCR-4.QAS				
Exit				Ctrl+Q

New Opens a splash screen, which displays options to create a new run file, open a recently used run file, or to open a Q Protocol.

Open Enables an existing run file to be opened. Select the run file and then click on the “Open” button. This file can be used as it is, or modified to create a new run file.

Save As	Saves the run file under the current file name, or under a new file name selected by the user. Any previous version will be replaced. All parameters except tip availability are saved.
Lab notebook	Allows the user to enter and save comments for a run file in plain text. Any comments will be displayed in a message box when the run file is opened and will be shown in the pre-run and post-run report.
Protocol description	Opens a description of the Q Protocol template which is currently loaded. This option is only available when a Q Protocol or User-Developed Protocol is loaded.
Unlock protocol	Unlocks the protocol which is currently loaded. This option is only available when a Q Protocol or User-Developed Protocol is loaded.
1-8	Lists the 8 run files which have been used most recently. Left-click to select and open one of these run files.
Exit	Closes the QIAgility Software.

“Control” menu

The “Control” menu provides options to send the instrument to its home position, start a run, or pause/abort a run.

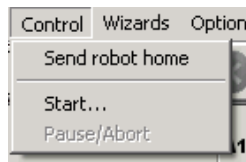

Send robot home	Initiates the instrument homing routine including tip ejection. After this routine the Y-arm will return to its resting position.
Start	Select this option to start a run. See Section 6.4.5 for more details about starting a run.
Pause/Abort	Pauses the instrument during a run. A dialog box will appear. Click on the "Continue Run" button to continue the run, or click on the "Abort Run" button to abort the run. See Section 6.5 for more details.

"Wizards" menu

The "Wizards" menu provides access to the "PCR setup wizard" and "Optimisation wizard". It also enables the user to import sample names, export reaction data, or generate pre-run reports.

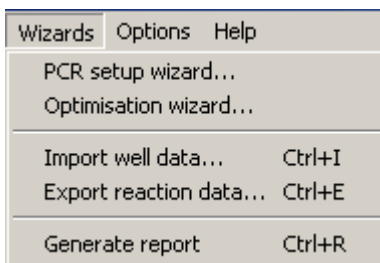

PCR setup wizard	Launches the "PCR Setup Wizard". This wizard can be used to create new run files. See Section 5.10.1 for further details.
Optimisation wizard	Launches the "Optimisation Wizard". This wizard enables specialized PCR functions to be set up. For example this wizard can be used for optimization of a PCR run (e.g., primer concentration). See Section 5.10.2 for further details.

Import well data	Opens the “Import Well Data” dialog box, which enables sample and reaction data to be imported from a file to a selected sample or reaction plate. See Section 5.9.7 for further details.
Export reaction data	Opens the “Export reaction Info” dialog box, which enables information about the contents of reaction wells from a selected reaction plate to be exported to another file. See Section 5.9.7 for further details.
Generate report	Opens a window which contains the pre-run report for the loaded run file. See Section 6.7.1 for further details.

“Options” menu

The “Options” menu includes options to manage user groups, manage calibration settings, and to configure pipetting and plate options.

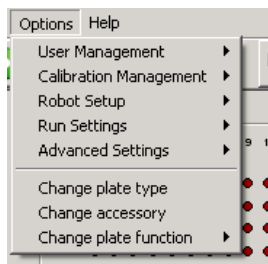

User management	Provides options to create user groups, and to enforce access restrictions on certain user groups. See Section 5.4 for further details.
User management — Enable Access Control	Enables or disables access control. If access control is enabled, a tick is displayed. Access control can only be enabled by an “Administrator”. See Section 5.4.3 for further details.

User management — Users & Groups	Enables creation of user groups. See Section 5.4.4 for further details.
User management — change current user	Enables the current user to be temporarily changed. A dialog box will appear, which enables an administrator to temporarily log-in. See Section 5.4.5 for further details.
Calibration management	Enables the transfer of calibrations and other software settings from one computer to another. This is useful when the instrument is connected to a new computer. See Section 5.5.
Calibration management — Save calibrations on setup disk	Enables calibration settings to be saved using a range of storage devices (e.g., USB stick). See Section 5.5.1.
Calibration management — Load calibrations from setup disk	Enables calibration settings to be loaded from a setup disk onto a computer. See Section 5.5.2.
Calibration management — Delete multiple calibrations	Enables deletion of multiple calibration settings. See Section 5.5.3.
Robot setup	Provides options to calibrate the instrument. These settings are maintained locally and are not associated with run files.
Robot setup — Calibrate plate heights	Defines the Z-axis location (i.e., height) of the inside base of the tube or wells of a plate. See Section 7.1.3.

- Robot setup — Calibrates the volume that is pipetted.
 Calibrate volumes — Ensures that the correct volume is accurately and precisely pipetted. See Section 7.1.6.
- Robot setup — Enables calibration of the position of each
 Calibrate plate positions — plate. Ensures that the pipetting head moves to the correct location for every well on a plate. See Section 7.1.2.
- Robot setup — Enables calibration of length variation
 Calibrate tip offsets — between different tip types. This calibration is optional. See Section 7.1.4.
- Robot setup — Calibrates the pipetting head to the tip
 Setup tip ejector — ejector. Enables correct tip ejection and ensures that the vacuum hub is not damaged. See Section 7.1.1.
- Robot setup — Enables selection of the COM port which is
 Select COM port — used for communication with the QIAgility. See Section 5.11.
- Robot setup — In “Virtual Mode”, this option enables or
 Enable UV light — disables a “virtual” UV lamp. When enabled, a tick will appear, and the UV lamp bulb icon will be activated in the toolbar.
- In “Normal Mode” this option is disabled. If a UV lamp is physically detected by the instrument hardware, this option will be ticked and the UV lamp bulb icon in the toolbar will be activated. If no UV lamp is detected, this option will not be ticked, and the UV lamp bulb icon in the toolbar will be inactive. See Section 6.2.

Robot setup — Service register	Opens the “Service Register” dialog box. This outlines the instrument service history. The service history is updated by QIAGEN Technical Services. See Section 5.12.
Run settings	Enables a number of run settings, including pipetting options (e.g., pipetting speed, tip reuse), extra volumes and level sensor settings to be adjusted. These settings are stored with the run file and allow the application to be reproduced on another instrument. See Section 5.6.
Run settings — Configure tip air intake	Enables the volume of air that the pipetting head takes up before aspirating liquid to be configured. The air is blown out upon ejection, ensuring that all liquid is ejected. See Section 5.6.1.
Run settings — Configure pipette speed	Enables adjustment of the pipetting speed (i.e., the aspirate/eject speed). See Section 5.6.2.
Run settings — Use liquid level when pipetting?	Enables the method of tracking liquid level to be selected. There are 3 options — “Do not use”, “Detect liquid level using sensor”, and “Use Liquid Level estimate”. See Section 5.6.9.
Run settings — Ignore errors during run?	Enables the software error level to be selected. There are 3 options — “Interrupt run on all errors”, “Interrupt run on serious errors”, and “Ignore all errors”. See Section 5.6.10.
Run settings — Set master mix extra volume	Enables the additional volume of master mix to be defined. See Section 5.6.3.

- Run settings — Set standard extra volume — Enables the additional volume of standard to be defined. See Section 5.6.4.
- Run settings — Set tip usage options — Enables configuration of tip usage. See Section 5.6.11.
- Run settings – Set concentration unit — Opens the “Set concentration unit” dialog, where a (physical) unit for concentrations to be displayed can be selected.
- Run settings - Allow use of multiple reagent volumes — Enables or disables the usage of different reagent volumes per reaction. A tick will appear when the option is enabled. See Sections 5.6.6 and 5.9.6
- Run settings — Set default file location — Enables the user to change the default file location for all saved files. See Section 5.6.5.
- Run settings — Save current settings as default — Saves current software run settings as the new default settings. This does not include calibration settings.
- Run settings — reset settings to factory default — Resets software settings to the factory defaults. Click on the “Yes” button to continue.
- Run settings — System colour configuration — Provides options to change the default colors which are used for all liquid groups on the software worktable. See Section 5.6.8.
- Run settings — shutdown beep? — Enables or disables the shutdown beep. A tick will appear when the shutdown beep is enabled.

Run settings — Allow screensaver?	Allows or inhibits operation of the separately configured Windows screensaver. A tick indicates that the screensaver is not inhibited.
Run settings — Generate file names for reaction export	Enables or disables automatic generation of unique file names for reaction exports. Unique file names are based on the run file name, time, and date. A tick will appear when this function is enabled.
Advanced settings	Provides additional options for use in specialist applications. Only change these settings under direct instructions from QIAGEN. See Appendix F for more detailed information about these settings.
Change plate type	Launches the “Plate Configuration” dialog box, which enables the user to change the plate type in a selected position on the software worktable. See Section 5.7.1.
Change accessory	Launches the “Select Accessory” window, which enables the user to add or remove an accessory from a selected position on the software worktable. See Section 5.7.1.
Change plate function	Enables selection of plate function. A tick will appear next to the plate function that has been selected. See Section 5.7.1.

“Help” menu

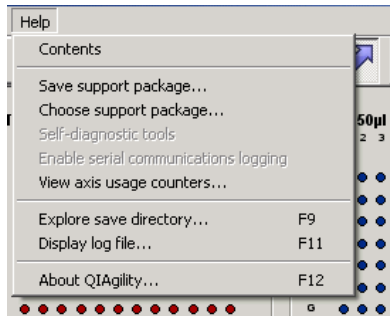

Contents	Opens a pdf file of the <i>QIAgility User Manual</i> .
Save support package	Creates a zipped support package. Select a file location and then click on the "OK" button. This package contains information about run settings, calibration data and log information. See Section 6.7.3.
Choose support package	Enables the user to view recent support packages. Support packages can be sorted based on name of run file, time of completion and type of error which occurred during the run. See Section 6.7.3.
Self-diagnostic tools	See Section 9.4 for more details.
Enable serial communications logging	This option should only be enabled under specific instruction from QIAGEN.
View axis usage counters	Allows the user to browse the number of movements each axis has performed since the last instrument service.
Explore save directory	Launches a file Explorer window with the default file directory where run files are saved.

- Display log file Displays the log file. This file contains information about the run setup and all commands sent to the instrument from the computer. The log file is updated as new runs are carried out, with the oldest data being deleted. See Section 6.7.3.
- About QIAgility Displays information about the QIAgility, including the version number, serial number and firmware number. QIAGEN contact details, which may be required to place orders or to request technical support, are also displayed.

5.3.2 Toolbar

This section outlines functions that are available from the toolbar menu.



Opens the start-up splash screen, which displays options to create a new run file, to open a recently used run file, or to open a Q Protocol.



Enables an existing run file to be opened. Select the run file and then click on the "Open" button. This file can be used as it is, or modified to create a new run file. See Section 6.4.2.



Saves the run file under the current file name, or under a new file name selected by the user. Any previous version will be replaced. All parameters except tip availability are saved.



Select this option to start a run. See Section 6.4.5.



Pauses the instrument during a run. A dialog box will appear. Click on the "Continue Run" button to continue the run, or click on the "Abort Run" button to abort the run. See Section 6.5.



Initiates the instrument homing routine. After this routine the instrument arm will return to its resting position.



Allows the user to enter and save comments for a run file in plain text. Any comments will be displayed in a message box when the run file is opened. This icon is not enabled when a Q Protocol is loaded.



Generates a pre-run report to assist with workspace setup for the current run.



Opens a PDF file of the *QIAgility User Manual*.



Enable the user to highlight the source and destination wells on the software worktable.



Opens the "UV Lamp Control" dialog box. If a UV lamp is not installed and enabled in the software, this icon is shown in gray. See Section 6.2.



Switches the HEPA filter on and off. The fan color alternates between green (on) and red (off). If a HEPA filter is not installed, this icon will be shown in gray. See Section 6.3.



Indicates a problem with the run. Errors must be resolved and acknowledged before the run can continue.



Opens the “Service Register”. See Section 5.12 for more details.



Unlocks a protocol.



Opens a protocol description for a Q Protocol.



Indicates that the run file which is currently open is a locked Q Protocol.



Indicates that the run file which is currently open is a locked User-Developed Protocol.

5.3.3 Mode indicator

When the software is operating in “Virtual Mode”, the following indicator is displayed.

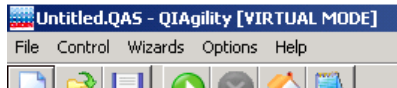

When the software is operating in “Normal Mode”, the following indicator is displayed.

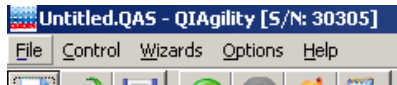

5.3.4 Software workspace

The software workspace supports the following features:

- Worktable
- Status bar
- Software version
- Instrument
- Liquid-level sensing option
- Tip reuse option
- User logged-in (Windows)
- Plate buttons

- Right-hand pane

Software worktable

The software worktable visually simulates the instrument worktable. The 6 SBS positions for plates are labeled A1, A2, B1, B2, C1 and C2. Positions for the Master Mix Block and Reagent Block are labeled M1 and R1.

Status bar

The status bar displays the current status of the instrument during a run.



Software version

This bar displays the current software version.

QIAgility v4.18.1

Instrument

This bar indicates whether the instrument is operating in "Virtual Mode" or "Normal Mode".

QIAgility (simulated)

QIAgility (simulated) Indicates that the instrument is operating in "Virtual Mode".

QIAgility Indicates that the instrument is operating in "Normal Mode".

Liquid-level tracking option

This bar indicates whether the liquid-level sensor is enabled. Double-click on this bar to change between "Tip sensor", "Estimate", and "Not Used".

A screenshot of a software bar with a light gray background and a thin border. The text "Liquid Level: Tip Sensor" is displayed in a dark gray font.

Tip sensor	Indicates that liquid-level sensing is enabled.
Estimate	Indicates that the liquid-level estimate function is enabled.
Not Used	Indicates that both liquid-level sensing and liquid-level estimate functions are disabled.

Tip reuse option

This bar indicates the tip reuse mode. Double-click on the bar to open the “Tip Usage” dialog box. See Section 5.6.11 for more details about setting tip usage options.

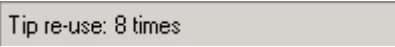
A screenshot of a software bar with a light gray background and a thin border. The text "Tip re-use: 8 times" is displayed in a dark gray font.

User logged-in





This bar displays the user that is currently logged-in to the software.

Plate buttons

Plate buttons are located in the top right corner of the schematic plates on the main software window. They provide information about the plates and appear when the cursor is moved over a plate.



The warning button is an exception, it will appear if the plate has not been position or height calibrated, and will remain visible until all of the calibrations for that plate have been completed.



 Warning	Prompts the user to proceed to plate calibration. Opens the "Set Alignment" dialog box if plate position calibration has not been completed, and opens the "Configure Plate Heights" dialog box if plate height calibration has not been completed.
 Zoom	Enlarges the view of the plate. Click again to return to the normal view.
 Info	Displays details about the current plate. Click on the "OK" button to return to the main software window.
 Toggle	Toggles between an image of the current plate and the plate schematic.

Right-hand pane

The right-hand pane refers to the area at the right side of the software workspace. It provides access to options which relate to different plate functions (i.e., tip, reaction, master mix, reagent, and sample). There is no right-hand pane for diluents, because the diluent does not have a definable function. In addition, when a run is in progress, a progress report is displayed in the right-hand pane.

The  icon is available at the top left of the right-hand pane when "Minimize" or "Restore" has been selected from the same icon in the menu bar. Left-click on the  icon to access the following options.

Restore	Reduces the size of the right-hand pane.
Move	Enables the right-hand pane to be moved.

Size	Click on the right-hand pane and then drag to increase or decrease the size of the right-hand pane in a vertical or horizontal direction.
Minimize	Minimizes the right-hand pane.
Maximize	Maximizes the right-hand pane.
Close	Closes the right-hand pane.
Next	No function.

Tip

Please refer to Section 5.9.1 for detailed information about the "Tip" right-hand pane.

Standard

Please refer to Section 5.9.2 for detailed information about the "Standard" right-hand pane.

Reagent

Please refer to Section 5.9.3 for detailed information about the "Reagent" right-hand pane.

Master mix

Please refer to Section 5.9.4 for detailed information about the "Mix" right-hand pane.

Sample

Please refer to Section 5.9.5 for detailed information about the "Sample" right-hand pane.

Reactions

Please refer to Section 5.9.6 for detailed information about the "Reaction" right-hand pane.

Progress report

Please refer to Section 5.9.8 for more detailed information about the “Progress report” right-hand pane.

5.4 User management

User management allows the definition of different access rights to various data and functions within the QIAgility Software.

User management functions are accessed from the menu bar (“Options/User management”).

5.4.1 User identification

Unlike software that requires separate login authentication, the QIAgility Software user is defined as the current Windows user logged on the laptop on which the software is installed.

The user identification function is always active and the user’s identification is reported in all pre and post run reports as well as diagnostic logs produced by the software during normal operation.

Note that access privileges are included only to support a particular use policy for the software and are not intended to prevent accidental or intentional circumvention of the policy or misuse of the software.

All users are able to edit and save modified run files (Section 5.10, page 5-127). If the run file is not saved with a new name, the previous run file data will be lost. If required, standard Windows file system write-protection mechanisms may be used to protect run-file data.

5.4.2 User classes

The QIAgility Software supports the following user groups:

- QIAgility Operator
- QIAgility Designer
- QIAgility Manager
- Windows Administrator

We will refer to Operator, Designer, Manager and Administrator.

Operator

An “Operator” user can navigate and view table layouts, run settings and reaction list data with “view/read only” access.

Operators have “edit” access to perform the following:

- Update “lab notebook” text information for a run file
- Set tip availability
- Assign identifiers and bar codes to plates, identifiers to wells, and bar codes to samples or reaction wells for a protocol run
- Modify the set of wells associated with sample banks used in the protocol run

An Operator cannot modify reaction properties.

Designer

A “Designer” user has all access rights as an Operator and, in addition, has “read/write” access to all functions of the software including the ability to:

- Design table layouts
- Calibrate the instrument
- Define run settings
- Setup the reaction list
- Import and export data

Designers are expected to define template run files (Section 6.4.3, page 6-9) and specify calibration data (Section 5.5, page 5-27, and Section 7) to be used by Operators.

Manager

A “Manager” has all the access rights of a Designer. In addition, Managers can:

- Enable and disable the access control function in the software (“Enable User Access” option, see Section 5.4.3, page 5-24)
- Update group membership for each of the QIAgility groups (if the Manager is also an Administrator)

Administrator

An “Administrator” has all the access rights of a Manager.

An Administrator user is a member of the standard local Windows administrator group and has full administrative access on the computer. This is necessary to update the QIAgility group membership.

A Manager enables the user access control.

A Manager/Administrator assigns users to groups (see the following sections).

When the software is restarted, only Administrators and users assigned to the “Manager”, “Designer”, and “Operator” groups can operate the software. Users not assigned to a user group are denied access when they attempt to start the QIAgility Software

When user access control is disabled, all users are given “Manager” access.

Upgrading the software does not affect user access control.

5.4.3 Enabling access control

Upon installation, the QIAgility Software user access control features are disabled and all users have “Manager” access. (See the previous section for user group descriptions.)

A Manager enables the user access control with “Options/User management/Enable access control”.

You can toggle between enabled and disabled states. A tick appears next to “Enable access control” when this option is enabled.

If the access control is enabled it is directly active. Be careful to enable the access control only if you are a Manager.

5.4.4 Managing user groups

If your computer belongs to a domain, the user groups have to be created and used in the domain. If you are working with a stand alone computer, the user groups are created and used locally. In both cases, local Administrators have full access to the software.

If you are a Manager, you can use the management functions on the menu bar “Options/User Management/Users & Groups” to change the groups membership. You must be an Administrator to save your changes.

To set the groups membership of users on the laptop computer:

1. Open the “Options” menu, and select “User management/Users & Groups”.
2. The “Users & Groups” window appears.
3. Select the user from the “Users” panel.

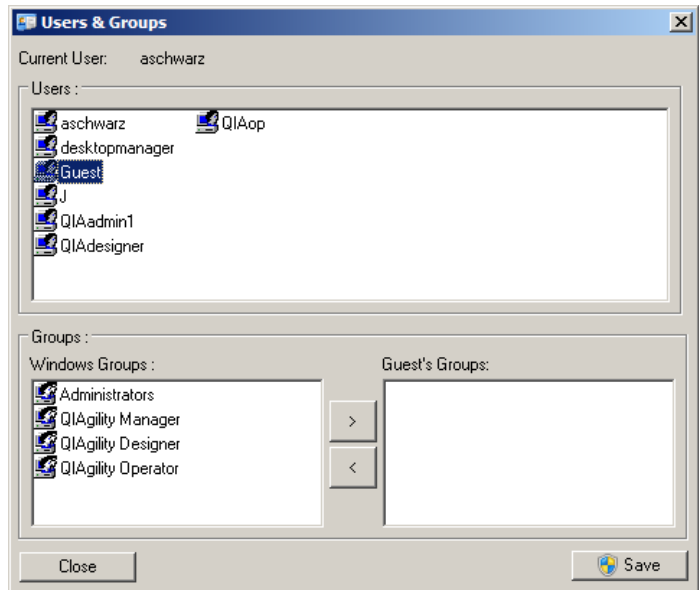

4. Select the group to which the selected user should be assigned (i.e., "Administrators", "QIAgility Manager", "QIAgility Designer", or "QIAgility Operator") in the "Windows Groups" panel.
5. Click the > button to move the selected group into the "Guest's Groups:" panel.

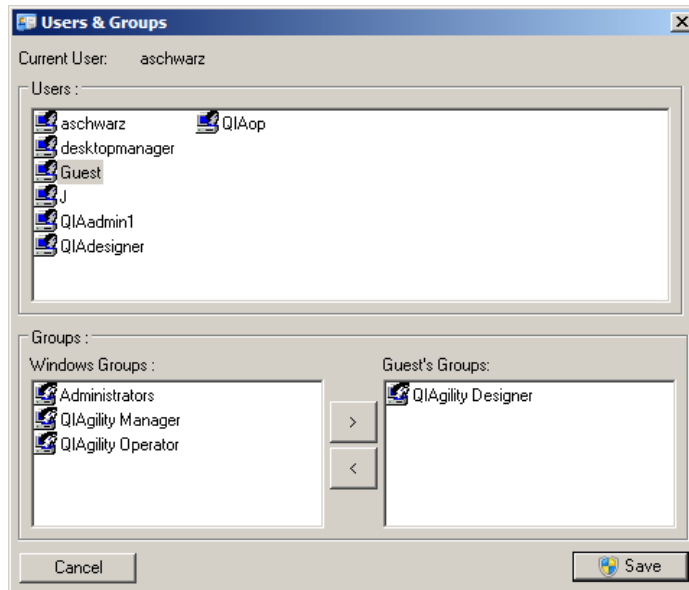

6. To assign the user to more than one group, repeat steps 4 and 5.
7. Click "Save" to save your changes. To do this you must be an Administrator. If you are not an Administrator, a pop-up of the operating system will appear to ask for elevation.

5.4.5 Change current user

To change users, the current user must shut down the software and log out of Windows. The new user must subsequently log in to Windows and restart the software.

Alternatively, select "Options/User Management/Change Current User". The "Change User" window appears. The new user must enter his username and password, and click "OK" to log on.



If the login was successful the new rights will take effect immediately.

5.4.6 Revert to first user

If you want to revert to the user who started the software, select "Options/User Management/Revert to First User".

5.5 Manage calibration data

The "Calibration Management" menu provides options to transfer calibration settings and other software settings from one computer to another, using a 'Setup Disk'. This is useful when the instrument is connected to a new computer. The 'Setup Disk' can be any storage device (e.g., USB stick).

Note: It is not necessary to use a 'Setup Disk' when the software is updated to a new version. Calibration settings will be retained.

Warning: A 'Setup Disk' that is created for one instrument should never be used with another instrument, as this may result in damage to the instrument.

5.5.1 Save calibrations on setup disk

To create a 'Setup Disk':

1. Select "Options/Calibration Management/Save calibrations on setup disk".

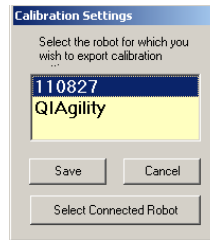

2. The “Calibration Settings” dialog box will appear. Ensure that the displayed serial number matches the serial number of the instrument that is connected. Click on the “Save” button to continue.

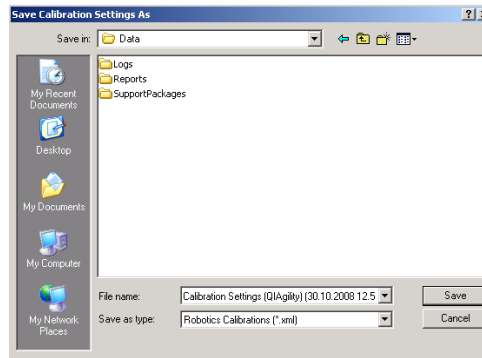

3. A default filename and location will be supplied. If desired, these can be changed.
4. Click on the “Save” button. The current calibration settings are now saved on the ‘Setup Disk’ and can be transferred to another computer.

5.5.2 Load calibrations from setup disk

To transfer calibration settings from a ‘Setup Disk’ to a different computer:

1. Select “Options/Calibration management/Load calibrations from setup disk”.

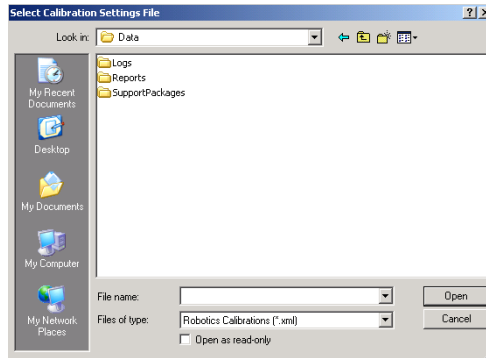

2. Select the file that contains the saved calibration settings. Click on the “Open” button.
3. If the instrument has existing calibration settings, the following dialog box will appear.

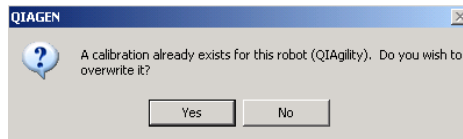

4. Click on the “Yes” button to overwrite the existing calibration settings.

5.5.3 Delete multiple calibrations

To delete existing calibration settings:

1. Select “Options/Calibration management/Delete multiple calibrations”.
2. The “Delete Multiple Calibrations” dialog box will appear.

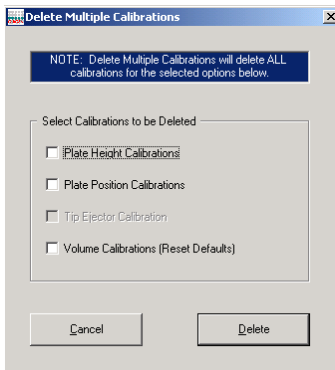

3. Select the calibration settings to be deleted.
4. Click on the “Delete” button. The selected calibrations will now be deleted.

5.6 Configure run settings

The “Run settings” menu provides options to configure a range of pipetting functions. The default run settings are the recommended settings. However, in some circumstances it is useful to adjust the run settings.

The default run settings are as follows:

Level Sensor	On
Error Mode	Interrupt run on all errors
Pipetting speeds	150 µl/second for all liquid groups, except 70 µl/second for viscous reagents
Standard extra volume	50 µl
Master mix extra volume	30 µl minimum extra volume, plus 1 µl extra volume per reaction
Air volumes	7 µl
Tip re-use	Use each tip for one operation only

5.6.1 Configure tip air intake

To configure the tip air intake:

1. Select "Options/Run Settings/Configure tip air intake".
2. The "Air" dialog box will appear.

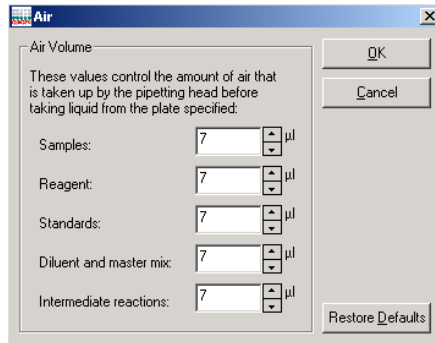

3. Enter the air volume in the boxes next to "Samples", "Reagents", "Standards", "Diluent and master mix" and "Intermediate reactions". Alternatively, to return to the default air volume settings, click on the "Restore Defaults" button.

Note: Larger air volumes may be beneficial when pipetting viscous liquids. Smaller air volumes may be beneficial when pipetting smaller volumes, or when dispensing into small tubes.

4. Click on the "OK" button to return to the main software window.

5.6.2 Configure pipet speed

To configure the pipetting speeds:

1. Select "Options/Run settings/Configure pipette speed".
2. The "Configure Pipetting Options" dialog box will open.

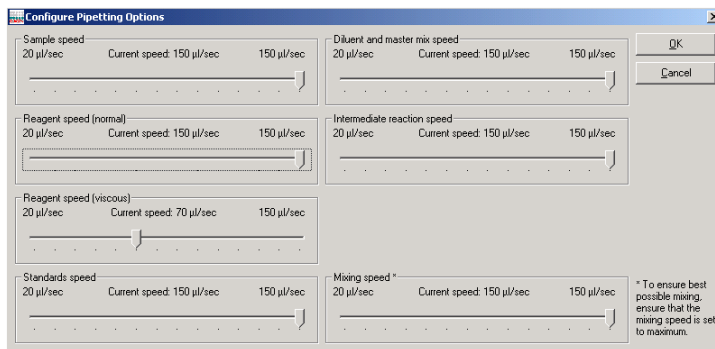

3. Left-click on the sliders and drag to adjust the pipetting speed for a given liquid group. Adjust the mixing speed in the same way.

Note: When pipetting a viscous liquid it is recommended to select a slower pipetting speed than the default value.

Sample speed	Defines the aspirate/eject speed when pipetting samples.
Reagent speed (normal)	Defines the aspirate/eject speed when pipetting normal reagents.
Reagent speed (viscous)	Defines the aspirate/eject speed when pipetting reagents which have been defined as viscous.
Standards speed	Defines the aspirate/eject speed when pipetting standards.
Diluent and master mix speed	Defines the aspirate/eject speed when pipetting diluent and master mix.
Intermediate reaction speed	Defines the aspirate/eject speed when pipetting to and from reaction wells.
Mixing speed	Defines the speed of all mixing operations.

- Click on the “OK” button to return to the main software window.

5.6.3 Set master mix extra volume

Extra master mix is required to account for evaporation and pipet loss during reaction setup. The master mix extra volume is defined by a minimum volume, plus an additional volume per reaction. The total volume is calculated by the software and rounded up to the next whole reaction.

Adjusting the minimum extra volume and per-reaction volume from their default settings can be useful when preparing master mix for manual PCR setup, or when preparing master mix for PCR setup at a later time.

To change the master mix extra volume settings:

- Select “Options/Run Settings/Set master mix extra volume”.
- The “Master Mix Extra Volume” dialog box will appear.

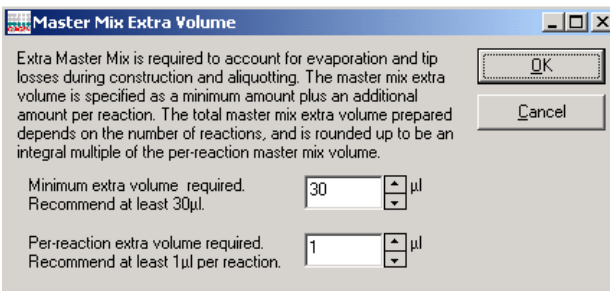

Minimum extra volume required

Defines the additional volume of master mix which is prepared.

Per-reaction volume

Defines the additional volume of master mix which is added for each reaction.

- Adjust the minimum extra volume and per-reaction volume.
- Click on the “OK” button to return to the main software window.

5.6.4 Set standard extra volume

When preparing standard dilutions, extra volume is required to account for evaporation and pipet loss. Changing the standard extra volume from the default setting can be useful when preparing standard dilutions for manual PCR setup or for PCR setup at a later time.

To change the standard extra volume:

1. Select "Set standard extra volume" from "Options/Run settings".
2. The "Standards Extra Volume" dialog box will open.

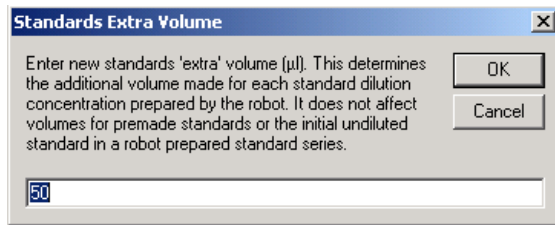

3. Enter a new extra volume.

Minimum extra volume required	Defines the additional volume which is prepared for each concentration of the standard dilution.
-------------------------------	--

4. Click on the "OK" button to return to the main software window.

5.6.5 Set concentration unit

A concentration unit can be assigned to make concentration values in the run more meaningful when presented in forms and in reports. The assigned unit does not change the way in which concentrations are handled or constructed.

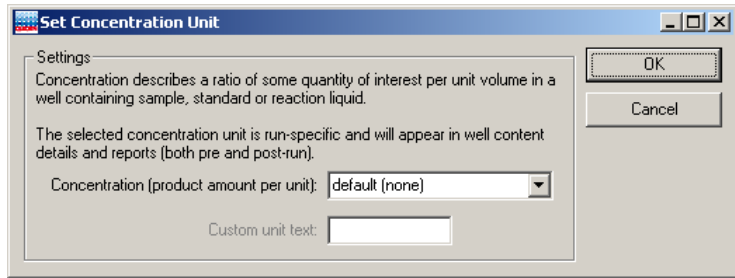

The available concentration units are:

- Default (none) — no concentration unit
- Copies/ μ l (copies per microliter)
- Copies/ml (copies per milliliter)
- % (percentage)
- IU/ μ l (international unit/microliter)
- IU/ml (international unit/milliliter)
- ng/ μ l (nanogram/microliter)
- μ g/ μ l (microgram/microliter)
- mg/ml (milligram/milliliter)
- pg/ml (picogram/microliter)
- \$/ μ l (dollars/microliter)
- Custom (user-defined)

5.6.6 Allow use of multiple reagent volumes

When activated a tick is visible.

If activated, the user sees the advanced reagents table in the reaction configuration form. This allows the user to configure the volume of a reagent for each reaction separately (instead of using the default volumes).

If deactivated, the user sees the simple reagents table in the reaction configuration form.

If multiple volumes for at least one reagent are used, and the user tries to deactivate the option, a message box appears:

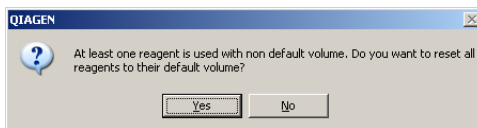

Click "Yes" to reset all used volumes of all used reagents in the current protocol to the reagent's default.

Click "No" to keep the option activated. No volumes will be changed.

5.6.7 Set default file location

The default file location for all saved files is C:\Program Files\QIAGility\Data. Run files are stored in this directory. This directory contains three subdirectories — "Logs", "Reports" and "SupportPackages". See Section 4.7 for more details about these subfolders.

To create a new default file location:

1. Select "Options/Run settings/Set default file location".

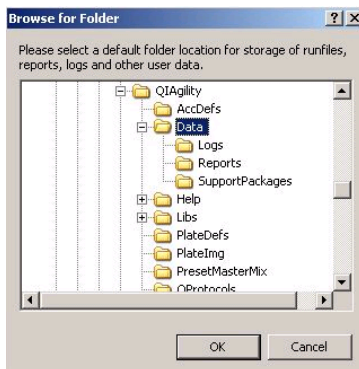

2. Browse for a new folder location.
3. Click on the "OK" button to continue. The subdirectories will automatically be generated in the new file location.

5.6.8 Configure system color

To configure the system colors:

1. Select "System color configuration" from "Options/Run settings".
2. The "System Color Configuration" dialog box will open. There are 3 tabs – "Sample Colours", "Liquid Colours", and "Selection Colours".

Sample Colours Enables configuration of sample colors.

Liquid Colours Enables configuration of liquid/reagent colors.

Selection Colours Enables configuration of colors that represent a liquid function and that represent members of a sample bank. In addition, colors used for selection and highlight indications can be configured.

Sample Colours

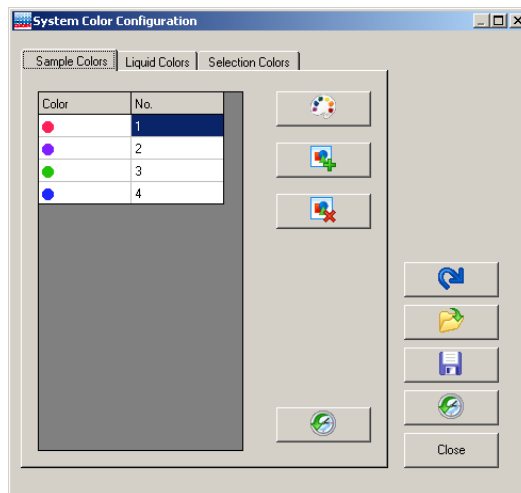

Liquid Colours

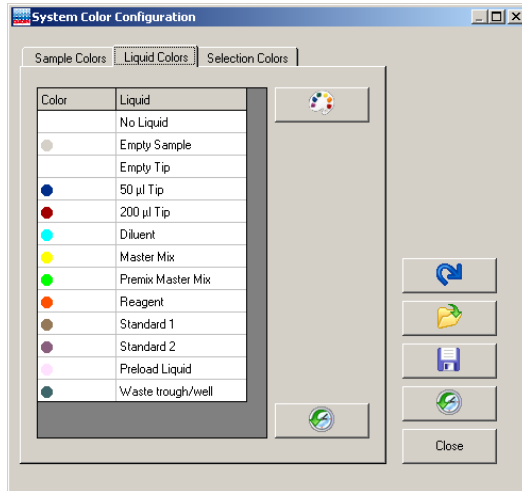



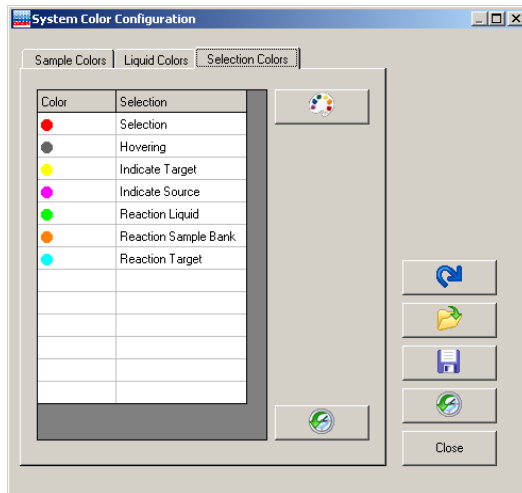

Selection Colours



Enables selection of a color.



Adds selected color.

	Deletes selected colors.
	Resets all sample colors. Click on the “Yes” button to continue.
	Refreshes the colors displayed on the software worktable according to the current settings.
	Opens color theme.
	Saves color theme.
Close	Closes and applies updated colors.

5.6.9 Adjust liquid level-tracking options

To adjust liquid level-tracking options:

1. Select “Options/Run settings/Use liquid level when pipetting?”.

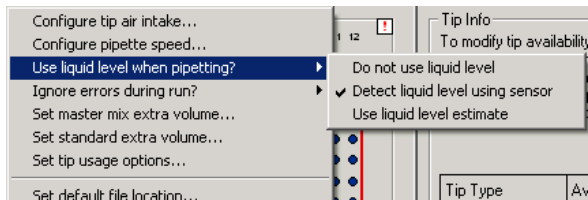

2. Select 1 of the 3 options — “Do not use liquid level”, “Detect liquid level using sensor”, or “Use liquid level estimate”. The “Use liquid level estimate” function is intended for use when the level sensing function cannot be used (i.e., if the liquid is covered with foil, or if the liquid is non-conductive).

Detect liquid level using sensor	Instructs the instrument to use the liquid-level sensor to track the liquid level. See Section 3.3.
----------------------------------	---

Use liquid level estimate	Instructs the instrument to use liquid-level estimate to track the liquid level. See Section 3.3.
Do not use liquid level	The instrument performs pipetting operations at the height calibration position for the plate/tube.

Note: These options are disabled if a Q Protocol is loaded and locked.

Warning: "Do not use liquid level" is not recommended for general use because liquid is more likely to be retained on the tip exterior. Pipetting accuracy and precision may therefore be compromised when using this option. This option is intended for use only in exceptional circumstances.

Note: For correct function of the liquid-level sensor, it is essential that the plates that are physically located on the instrument worktable are correctly assigned in the software.

Note: The "Use liquid level estimate" function relies on the assumption that source wells are initially supplied with the volume of liquid that has been calculated by the software. Overfilling the source wells can cause excess liquid to be retained on the tip exterior. Underfilling the source wells causes insufficient volumes to be aspirated and then pipetted.

3. A tick will appear next to the option that has been selected.

Note: The global liquid level tracking options defined here can be overwritten locally per plate segment. (See also "Set liquid level mode for segment" in Section 5.7.1.)

5.6.10 Set liquid-level tracking error level

If a tube contains insufficient liquid to complete a reaction setup, an error message will appear. User intervention will be required to continue with the run.

However, if sample availability is limited, it may be desirable for a tube to contain less liquid than the detection limit. If the default setting is enabled (i.e., “Do not ignore errors”), an error message will appear every time an aliquot is taken from the tube. To avoid the need for user intervention every time an aliquot is taken, a different error level can be selected.

To set the liquid-level tracking error level:

1. Select “Options/Run Settings/Ignore errors during run?”.

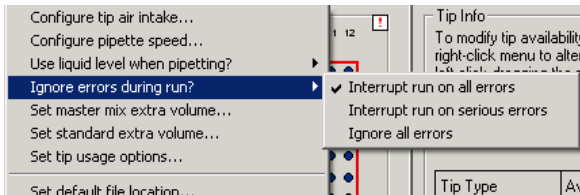

2. Select 1 of the 3 options — “Interrupt run on all errors”, “Interrupt run on serious error”, or “Ignore all errors”.

Interrupt run on all errors	This is the default error level. All liquid-level tracking errors are reported during a run and user intervention is required every time an error occurs.
Interrupt run on serious error	User intervention will be required for system errors, but not for errors caused by insufficient liquid.
Ignore all errors	All level sensing errors will be ignored.

Note: These options are disabled if a Q Protocol is loaded and locked.

3. A tick will appear next to the option that has been selected.

Note: All errors are reported in the post-run report, regardless of which liquid-level tracking error is selected. This cannot be disabled.

5.6.11 Set tip usage options

Tip reuse can provide a significant reduction in the number of tips which are used during a run.

To configure tip usage:

1. Select "Options/Run Settings/Set tip usage options".
2. The "Tip Usage" dialog box will appear.

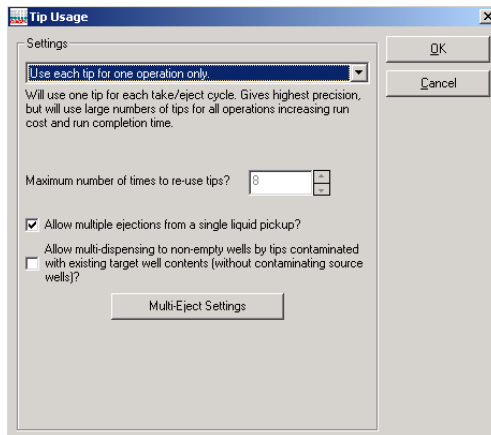

Use each tip for one operation only	One tip will be used for each aspirate/eject cycle. This option gives the highest accuracy and precision, but requires a large number of tips. Run duration will be increased.
-------------------------------------	--

Re-use tips where possible	Tips will be reused where possible. More than one aspirate/eject cycle will be performed using the same tip. Run duration will be decreased, but accuracy and precision will be compromised.
----------------------------	--

Maximum number of times to re-use tips	Defines the maximum number of times tips are reused. This option is only available when tip reuse has been selected.
--	--

<p>Allow multiple ejections from a single liquid pick up?</p>	<p>Select to allow multiple liquid ejections from a single aspirate.</p>
<p>Allow multi-dispensing to non-empty wells by tips contaminated with existing target well contents (without contaminating source wells)?</p>	<p>Allows multi-ejection into wells which already contain liquid. This is only allowed where cross-contamination would not occur.</p>
<p>Multi-Eject Settings</p>	<p>Opens the "MULTI-EJECT options for Application Settings" dialog box, which enables multi-eject options to be configured.</p>

Note: These options are disabled if a Q Protocol is loaded and locked.

3. Select "Use each tip for one operation only", or select "Re-use tips where possible" from the drop-down menu.
4. If tip reuse has been selected, define the "Maximum times to re-use tips".

Note: Tip reuse lowers accuracy and precision due to retention of liquid on the tip interior and exterior. It is therefore recommended that a tip is reused a maximum of 8 times.

5. If desired, select the multi-ejections and multi-dispensing options. If "Allow multi-ejections from a single liquid pickup?" is selected, the "Multi-Eject Settings" button becomes an option. Click on this button to configure multi-eject options. See Section 5.6.12 for more details.
6. Click on the "OK" button to return to the main software window.

5.6.12 Configure multi-eject options

1. Select "Options/Run Settings/Set tip usage options".
2. The "Tip Usage" dialog box will appear. See Section 5.6.11 for more details about configuring tip usage options.
3. Select "Re-use tips where possible", or "Use each tip for one operation only", and then click on the "Multi-Eject Settings" button.
4. The "MULTI-EJECT" dialog box will open.

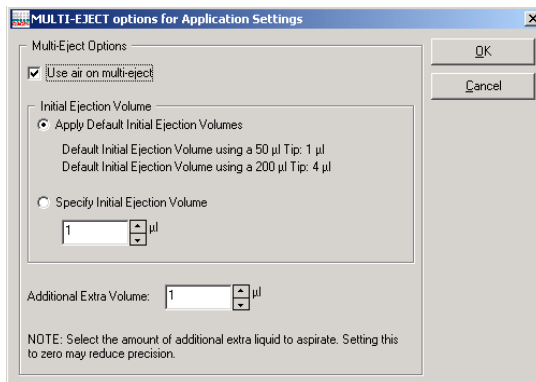

Use air on multi-eject

Select to blow out air on the final ejection. This limits accumulation of liquid on the tip interior. This is a default setting when tip reuse is selected, but is an optional setting when single tip usage has been selected.

Apply Default Initial Ejection Volumes

Select to apply default initial ejection volumes (i.e., 1 µl for 50 µl tips, and 4 µl for 200 µl tips).

Specify Initial Ejection Volume

Select to specify initial ejection volumes. The initial ejection volume is the volume that is aspirated and ejected into the source well before ejecting into target wells starts.

Additional Extra Volume Use this option to specify the extra volume to aspirate.

5. If tip reuse is disabled (i.e., each tip will be used only once), deselect "Use air on multi-eject".
6. Select either "Apply Default Initial Ejection Volumes", or select "Specify Initial Ejection Volume". If "Specify Initial Ejection Volume" is selected, define the initial ejection volume.
7. Define the "Additional Extra Volume".
Note: Setting this value to zero may reduce precision. It is recommended to set this volume to half the volume of the aliquot.

5.7 Define worktable setup

5.7.1 Plate operations

The plate operations menu provides options to change plate type, change plate function, manage tip availability, and manage sample banks.

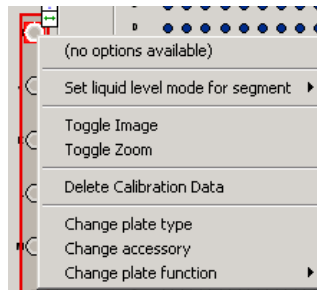

(no options available)

When the selected plate or segment has "Tip", "Reaction", "Mix", or "Sample" function, further options will be available in this panel. See Sections 5.7.2, 5.8.1, and 5.9.4 for further details about these options.

Set liquid level mode for segment	Enables the method of tracking liquid level to be selected for a specific plate/segment. All other plates/segments, unless otherwise defined using this function, will use the method that is defined in the "Options" menu. See Section 5.6.9 for details about how to configure the liquid-level tracking options from the "Options" menu.
Toggle Image	Click to toggle between an image and a schematic of the current plate type. This option has the same function as the "Switch" plate button.
Toggle Zoom	Click to toggle between an enlarged view and a normal view of the current plate type. This option has the same function as the "Zoom" plate button.
Delete Calibration data	Deletes all calibration settings associated with the plate.
Change plate type	Opens the "Plate configuration" dialog box, which enables the plate type and the tubes associated with a plate to be changed. See "Changing the plate type" in this section.
Change accessory	Opens the "Select Accessory" dialog box, which enables addition or removal of a special accessory from the worktable. See "Adding/removing an accessory" in this section.
Change plate function	Enables the plate function to be changed. A tick will appear next to the plate function that has been selected. See "Changing the plate function" in this section.

“Plate configuration” dialog box

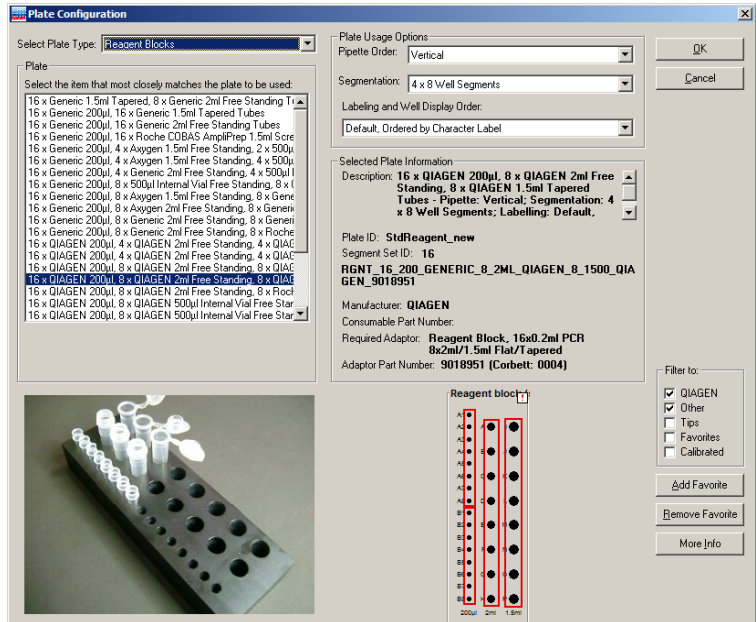

Select Plate Type

Enables the plate type to be selected from the drop-down menu (e.g., Rotor-Gene, Standard 96 Well). Plates which match the selection will be listed in the “Plate” panel.

Plate

Lists plates that match the plate type selection in the “Select Plate Type” drop-down menu. Select a plate from this list to view an image of the plate, a plate schematic and “Selected Plate Information”.

Pipette Order

Enables the pipet order to be selected from a drop-down menu. Available options vary depending on the selected plate type.

Segmentation	<p>Enables the number of segments on the plate to be selected from a drop-down menu. Available options vary depending on the plate type.</p> <p>The segmentation groupings are displayed in the plate well layout diagram according to the selection made.</p>
Labelling and Well Display Order	<p>This determines the sequence in which wells are displayed in the sample data grid (i.e., "Label Sequence" or "Pipetting Sequence"). Each plate type has a specific 'pipetting' order and specific 'label' order. Where these are different (e.g., vertical pipetting order and horizontal label order), the sequence in which wells are listed in the grid changes according to the well display order selection. This function is useful, for example, when it is convenient to dispense liquids by column (vertical pipetting order), but to export the data by row (horizontal label order).</p>
Filter to:	<p>Enables the list of plates in the "Plate" panel to be filtered. Select "QIAGEN", "Other", "Tips", "Favorites", and/or "Calibrated". If "QIAGEN" is selected, only QIAGEN plate types will be displayed in the "Plate" list.</p>
Add Favorite	<p>Adds a selected plate type to a list of favorite plate types.</p>
Remove Favorite	<p>Removes a selected plate type from a list of favorite plate types.</p>
More Info	<p>Opens the "Plate Information" dialog box, which displays more information about a selected plate type.</p>

Changing the plate type

Before starting a run the correct plate type must be selected in the software. The physical plate type in use at a given location on the worktable must match the plate type selected for this location in the software. This ensures that the software uses the correct calibration settings for that plate.

To change the plate type in the software, proceed as follows:

1. Position the cursor above the plate that is to be changed. Right-click on the mouse. The plate operations menu will appear.
2. Select "Change plate type" from the plate operations menu.
3. The "Plate Configuration" dialog box will appear.
4. Select a plate type from the "Select Plate Type" drop-down menu. The "Plate" list will be automatically updated.
5. Select a plate from the "Plate" list.
Note: If you cannot find a plate type that matches, or is very similar to the plate that you are using, please contact QIAGEN Technical Services.
6. Click on the "OK" button to continue.

Changing the plate function

Before starting a run the correct plate function must be selected for each plate on the worktable. Some plates (e.g., Reagent Blocks) have more than 1 segment. Different plate functions can be selected for different segments of the same plate. There are 7 plate functions — "Sample", "Reagent", "Mix", "Reaction", "Standard", "Diluent", and "Tip".

Sample	A sample is always added to a reaction last. Samples must be assigned to a sample bank before they can be used in a reaction setup.
--------	---

Reagent	A reagent can be combined with other reagents to make a master mix, or added individually to a reaction. Reagents are always dispensed to reaction wells before samples.
Mix	A master mix is a pooled group of reagents that can be added to a reaction plate. Master mix is always added to a reaction first because it normally constitutes the largest volume of the reaction.
Reaction	A reaction is the destination for the samples, master mixes, and reagents. Reactions can be assigned to a sample bank — this enables a reaction to be a component of a different reaction. A reaction that is a component of another reaction is called an 'Intermediate' reaction.
Standard	A standard is a dilution series with known concentrations. Standards are treated like samples.
Diluent	Diluent is used to dilute the master mix, dilute samples, and create standard dilution series. It is assumed to be PCR-grade water. A diluent can only be assigned to a single well segment. Only 1 diluent tube can be assigned in a run file.
Tip	The plate contains a Tip Rack Holder and tips. Tips must be set to available or unavailable.

To change the plate function:

1. Right-click on the plate, or the segment of a plate, that is to be changed. The plate operations menu will appear.

2. Select "Change plate function". The available plate functions will appear as a submenu.
3. Select a plate function. A tick will appear next to the function that has been selected.
Note: If the selected plate type is a Tip Rack Holder, the only available function for the plate will be "Tip".

Adding/removing an accessory

If required, an accessory (e.g., cooling block) can be added under a plate.

Note: Use of an accessory affects the plate height. Plate height calibration must therefore be performed with the plate and accessory together.

To add or remove an accessory:

1. Right-click on the plate where the accessory is to be added/removed. The plate operations menu will appear.
2. Select "Change accessory". The "Select Accessory" dialog box will appear.

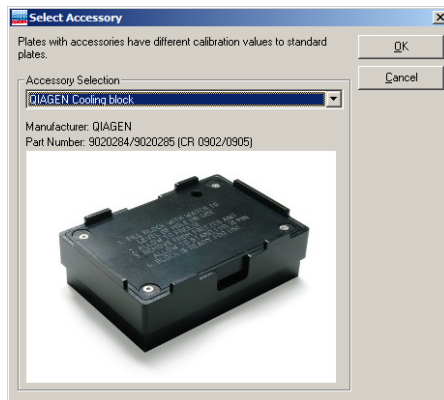

3. Select the required accessory from the drop-down menu. An image of the accessory will appear. Alternatively, to remove an accessory, select "No accessory" from the drop-down menu.
4. Click on the "OK" button to return to the main software window. A plate which is associated with an accessory

will now have a colored background in the main software window.

Set liquid level mode for segment

1. Right-click on a plate or segment with "Sample" or "Reaction" function.
2. Select "Set liquid level mode for segment". A submenu will appear.

Do not use liquid level	The instrument performs pipetting operations at the height calibration position for the plate/segment.
-------------------------	--

Detect liquid level using sensor	The instrument performs pipetting operations for the plate/segment using the liquid-level sensor. See Section 3.3.
----------------------------------	--

Use liquid level estimate	The instrument performs pipetting operations for the plate/segment using the liquid-level estimate function. See Section 3.3.
---------------------------	---

Use default liquid level mode (Tip Sensor)	The instrument performs pipetting operations for the plate/segment using the method that has been defined in the "Options" menu. See Section 5.6.9 for more details about how to configure liquid-level tracking options from the "Options" menu.
--	---

3. Select 1 of the 4 options for detecting the liquid level from the submenu. A tick will appear next to the method which has been selected.

Note: All other plates/segments, unless otherwise defined using this function, will use the method that is defined in the "Options" menu. See Section 5.6.9 for more details about how to configure liquid-level tracking options from the "Options" menu.

5.7.2 Setting tip availability

Tip availability must be set for every plate which has “Tip” function. This enables the software to determine exactly where tips are available on the instrument worktable. If this information is incorrect, the run will not proceed correctly because the instrument may attempt to pick up a tip from a location where no tip is available.

To change tip availability:

1. Left-click on a plate that has “Tip” function to select all the tips within that plate. Alternatively, to select a group of tips, left-click on the plate and then drag. Selected tips will be highlighted red.

Note: To select individual tips, left-click on an individual tip and proceed as for a group, or use the tip availability short cut.

Tip availability short cut Hold down “Alt” and left-click on individual tips to switch the tip between available and unavailable.

2. Right-click on the plate. Tip availability options will appear in the upper panel of the plate operations menu.

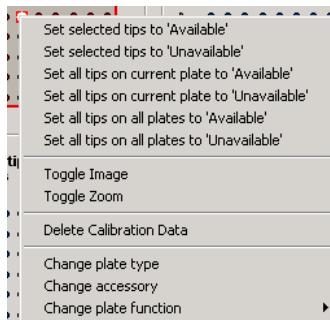

Set selected tips to “Available”/- “Unavailable” Sets a group of tips to “Available” or “Unavailable”. Before using this option, tips must be selected.

Set all tips on current plates to "Available"/-"Unavailable"
Sets all of the tips to "Available" or "Unavailable".

Set all tips on all plates to "Available"/-"Unavailable"
Sets all tips to "Available" or "Unavailable".

3. Select one of the options to make the selected tips "Available" or "Unavailable". "Available" 200 µl tips are shown in dark red on the software worktable, "Available" 50 µl tips are shown in dark blue, and "Unavailable" tips are shown in white.
4. Only 1 group of tips can be selected at a time. To make more than one group of tips "Available" or "Unavailable", repeat steps 1–3 for each group of tips.

5.8 Managing samples

5.8.1 Managing sample banks

A sample bank is a collection of wells on a given plate or plate segment that is grouped and treated as a single unit for liquid handling operations.

Individual "Sample" wells must be assigned to a sample bank before they are available for use in a reaction setup. "Reaction" wells can also be assigned to a sample bank — this enables a reaction to be used as a component of a second reaction.

Sample banks are managed using the "Update Sample Bank" dialog box. The "Update Sample Bank" dialog box can be accessed from the plate operations menu, or from the "Sample" right-hand pane. See Section 5.9.5 for more detailed information about managing sample banks using the "Sample" right-hand pane.

Right-click on a “Sample” or “Reaction” plate to view sample bank options in the upper panel of the plate operations menu. Select any of these options, apart from “Toggle sample bank list” and “Set preload volume”, to directly display the “Update Sample Bank” dialog box.

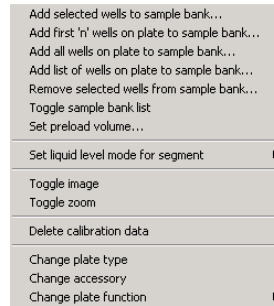

- | | |
|---|---|
| Add selected wells to sample bank | Opens the “Update Sample Bank” dialog box and enables selected wells to be added to a new or existing sample bank. |
| Add first ‘n’ wells on plate to sample bank | Opens the “Update Sample Bank” dialog box and enables consecutive wells on a plate to be added to a new or existing sample bank. |
| Add all wells on plate to sample bank | Opens the “Update Sample Bank” dialog box and enables all wells of the selected plate segment to be added to a new or existing sample bank. |
| Add list of wells on plate to sample bank | Opens the “Update Sample Bank” dialog box and enables a list of wells to be defined and added to a new or existing sample bank. |
| Remove selected wells from sample bank | Opens the “Update Sample Bank” dialog box and enables selected wells to be removed from an existing sample bank. |

- Toggle sample bank list** Opens the “Sample Banks” panel of the “Sample” right-hand pane. This option is only available when a “Reaction” plate is selected. See Section 5.9.5 for more information on managing sample banks using the “Sample Banks” panel.
- Set preload volume** Enables the user to enter the volume of liquids which have been preloaded into reaction tubes. This option is only available when a “Reaction” plate is selected. Click on the “OK” button to continue.

“Update Sample Bank” dialog box

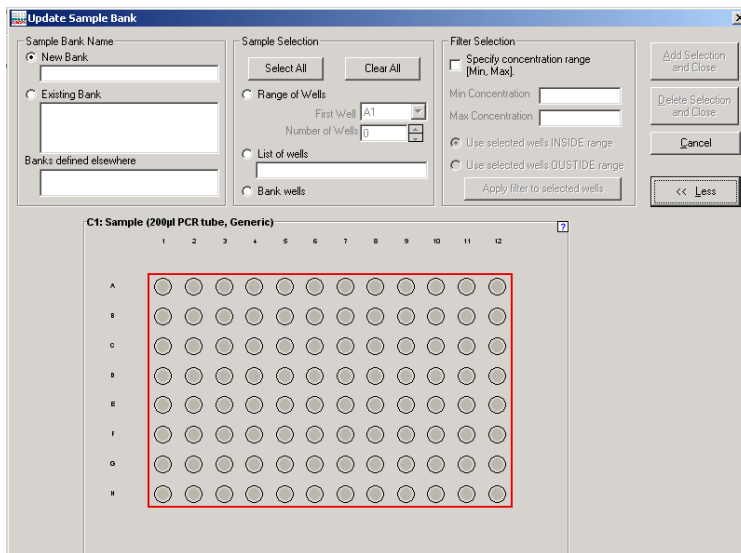

- New Bank** Select to create a new sample bank. Insert a sample bank name. Sample bank names must be unique within the run.
- Existing Bank** Select to modify an existing sample bank. Current sample banks that are defined for the selected plate/segment are listed.

Banks defined elsewhere	Lists all sample banks that are defined in the run file.
Select all	Selects all of the wells within the plate.
Clear all	Deselects all of the wells within the plate.
Range of wells	Select to define a consecutive range of wells. Specify the "First well" and then specify the "Number of wells".
List of wells	Lists the range of wells (e.g., A1–B1) that is selected. This list is automatically updated when the well selection is changed. In addition, a list can be directly entered into this field to select wells. A list can consist of more than one description (e.g., A1–B2, C2–C6).
Bank wells	Click to view the existing wells in the sample bank. Wells are highlighted red.
Specify concentration range	Select to define a concentration range for the filter. Specify the "Min Concentration", "Max Concentration", and whether to use selected wells "INSIDE" or "OUTSIDE" the defined concentration range.
Apply filter to selected wells	Adds or removes samples from a sample bank, based on a defined concentration range. The filter is immediately applied to the current selection.
Add Selection and Close	Adds selected wells to the sample bank. The "Update Sample Bank" dialog box will then be closed.
Delete Selection and Close	Deletes selected wells from the sample bank. The "Update Sample Bank" dialog box will then be closed.

Cancel	Closes the "Update Sample Bank" dialog box.
More	Opens the "Sample selection" and "Filter selection" panels, in addition to the "Sample Bank Name" panel.
Less	Closes the "Sample selection" and "Filter selection" panels.

Create a new sample bank

1. To select all of the wells within a plate, left-click on a plate with "Sample" or "Reaction" function. To select a group of wells within a plate, left-click on the plate and then drag. Selected positions will be highlighted red.
2. Right-click on the plate to view the plate operations menu. Select "Add selected wells to sample bank". The "Update Sample Bank" dialog box will open.
3. Select "New Bank" and enter a name for the new sample bank.
4. If desired, left-click and drag on the plate schematic in the lower portion of the dialog box to modify the original well selection. Alternatively, options in the "Sample Selection" panel and "Filter Selection" panel can be used to select wells.
5. Click on the "Add Selection and Close" button. The selected wells will now appear in color on the software worktable.
6. To add another group of wells to this sample bank, proceed as for "Modifying an existing sample bank".

Modifying an existing sample bank

1. To select all of the wells within a plate, left-click on a plate with "Sample" or "Reaction" function. To select a group of wells within a plate, left-click on the plate and then drag. Selected positions will be highlighted red.

2. Right-click on the plate to view the plate operations menu. Select "Remove selected wells from sample bank". The "Update Sample Bank" dialog box will open.
3. Select "Existing Bank" and then select a sample bank from the list.
4. If desired, left-click and drag on the plate schematic in the lower portion of the dialog box to modify the original well selection. Alternatively, options in the "Sample Selection" panel and "Filter Selection" panel can be used to select wells.
5. To add selected wells to the existing sample bank, click on the "Add Selection and Close" button. To remove selected wells from the existing sample bank, click on the "Delete Selection and Close" button.

5.9 View and edit information using the right-hand pane

Before setting up a reaction list, all plate functions must be configured. This can be done using the right-hand pane. The right-hand pane refers to the area on the right-hand side of the software workspace. Left-click on a plate in the main software window to view information relating to plate function in the right-hand pane.

A plate, segment, or well can have 1 of 7 functions — "Tip", "Standard", "Reagent", "Mix", "Sample", "Reaction", or "Diluent". All functions, except "Diluent", have an associated right-hand pane. See Sections 5.9.1 to 5.9.6 for more detailed information about these right-hand panes.

When a run is in progress, a progress report is displayed in the right-hand pane. See Section 5.9.8.

5.9.1 Tip

Tip availability is updated in real time while the software is operating, and is recorded when software is shut down. Tip availability should therefore be correct when the software is restarted. However, correct tip availability should always be checked before starting a run.

Two tip types can be used with the QIAgility — 50 µl and 200 µl. In the software worktable, 50 µl tips are colored blue, and 200 µl tips are colored red.

To view information about current tip availability, tip requirements, tip location and tip type, left-click on a plate with “Tip” function in the software worktable. The “Tip” right-hand pane will appear.

“Tip” right-hand pane

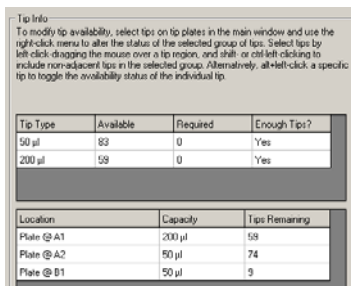

Tip Info
To modify tip availability, select tips on tip plates in the main window and use the right-click menu to alter the status of the selected group of tips. Select tips by left-click-dragging the mouse over a tip region, and shift- or ctrl-left-clicking to include non-adjacent tips in the selected group. Alternatively, alt-left-click a specific tip to toggle the availability status of the individual tip.

Tip Type	Available	Required	Enough Tips?
50 µl	83	0	Yes
200 µl	59	0	Yes

Location	Capacity	Tips Remaining
Plate @ A1	200 µl	59
Plate @ A2	80 µl	74
Plate @ B1	50 µl	9

5.9.2 Standards

Standard dilutions can be prepared using the QIAgility, or a premade dilution series can be used. The default location for standards is at the left of the Reagent Block. There may be more than one location for a standard dilution series, each of these locations operates independently of other dilution series.

Standard dilutions are set up using the “Standard” right-hand pane. To view the “Standard” right-hand pane, left-click on any plate or well with “Standard” function.

“Standard” right-hand pane

Standard Options

Use standard?

Use pre-mixed standard series?

Standard name: Standard 1

Standard Series Size

No. of dilution concentrations (including first undiluted standard): 5

Standard Dilution Options

Concentration of first standard: 1

Enable mixing during dilution?

No. of times to mix diluent and standard: 5

Change tips after each dilution?

Minimum volume required if unused in reactions: 0

Standard Data

Robot prepared standard is not used in reactions. All wells are empty.

	Dil. ratio	Concentration	Water	Sample	Total
A1	1 in 10	1			0 µl
A2	1 in 10	0.1			0 µl
A3	1 in 10	0.01			0 µl
A4	1 in 10	0.001			0 µl
A5	1 in 10	0.0001			0 µl

- Use standard? Select to use a standard. This makes other options in the “Standard” right-hand pane available.
- Use pre-mixed standard series? Select if using a premade standard dilution series. The “Set Custom Conc.” button will become available.
- Standard name Displays the default name of the standard dilution series. If desired, click in the box and enter a different name.
- No. of dilution concentrations Defines the number of dilution concentrations.
- Concentrations of first standard Defines the concentration of the first standard.
- Enable mixing during dilution Enables mixing during dilution.

No. of times to mix diluent and standard	Defines the number of times to mix diluent and standard.
Change tips after each dilution?	Instructs the instrument to change tips after each dilution.
Minimum volume to prepare (if unused)	Sets the minimum volume of standards to create if the standards are not used in any reactions. This allows the user to create one set of standards that can be used for multiple subsequent runs. The minimum volume will be the volume entered, plus the volume that is defined in the "Standard extra volume" field in the "Run settings" menu. This value is ignored when the standard is used in at least one reaction configured in the run.
Set Custom Conc.	Opens the "Custom Concentration" dialog box, which enables the concentration of dilutions to be defined. Click on a cell in the table to directly enter a concentration. Alternatively, click on the "Restore Defaults" button to return to the default concentration values. Click on the "OK" button to continue.

Using a premade standard dilution series

1. Left-click on a plate or well with "Standard" function. The "Standard" right-hand pane will appear.
2. Select "Use standard?" and "Use pre-mixed standard series?".
3. If desired, click in the "Standard name" field and enter a different name for the premade standard dilution series.
4. Enter the number of dilution concentrations. The "Standard Data" table will automatically be updated with default dilution ratios and concentrations.

5. Enter the concentration of the first standard. Press "Enter" to update the "Standard Data" table.
6. Individually click on cells in the "Standard Data" table in the "Concentration" column to enter the concentrations of the premade standard dilution series.
7. After entering each concentration, click on the "OK" tab to automatically update the dilution ratios. Concentrations can also be entered using the "Custom Concentration" dialog box, see below.

Note: Concentration values are assumed to be entered in a single unit common to all values in the run. The unit itself can be defined as needed for the application. See section 5.6.5.

Entering concentrations using the "Custom Concentration" dialog box

1. Click on the "Set Custom Conc." button in the "Standard" right-hand pane. The "Custom Concentration" dialog box will appear.

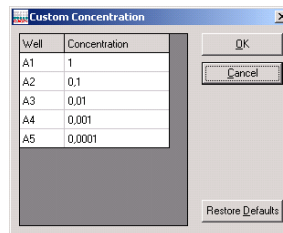

2. Individually click on cells in the table in the "Concentration" column and enter the concentrations of the premade standard dilution series.
3. After entering each concentration, click on the "OK" tab to update the table. If desired, click on the "Restore Defaults" button to return to the original default concentrations.
4. Click on the "OK" button.

Preparing a standard dilution series using the QIAgility

Note: This function is only available if a diluent well is placed on the worktable.

1. Left-click on a plate or well with "Standard" function in the main software window. The "Standard" right-hand pane will appear.
2. Select "Use standard?". If desired, click in the "Standard name" field and enter a different name for the standard dilution.
3. Enter the desired number of dilution concentrations. The "Standard Data" table will automatically be updated with default dilution ratios and concentrations.
4. Enter the concentration of the first standard. Press "Enter" to update the "Standard Data" table.
5. If a dilution series with varying ratios is required, the dilution ratios can be modified. To do this, click on a cell in the "Standard Data" table and enter a different dilution ratio. Click on the "OK" tab to automatically update the concentration. The diluent volume, sample volume and total volume columns are automatically updated when the standard is used in a reaction.
6. Select "Enable mixing during dilution?" and enter a value for the "No. of times to mix diluent and standard". It is recommended that a minimum of 5 mixes is entered.
7. Standards are typically prepared using the same tip. If desired, each dilution can be prepared using a new tip. To select this option, select "Change tips after each dilution?".
8. Specify the "Minimum volume to prepare if unused".

Alternatively, the dilution series can be set up from a list of concentrations. To do this:

1. Select "Use standard?" and "Use pre-mixed standard series?".
2. Enter the list of concentrations, either using the "Custom Concentration" dialog box, or by entering the values directly into the "Standard Data" list.
3. Dilution ratios will be automatically calculated.
4. Deselect "Use pre-mixed standard series?".

See Section 5.6.4 for more details about setting the standards extra volume.

5.9.3 Reagents

The default location for reagents is on the right side of the Reagent Block. Some plates have several segments and therefore have more than one option for the location of reagents.

Reagents can be added directly into reaction tubes, or can be used to make up a master mix, which can then be added to reaction tubes. To improve precision and accuracy, it is recommended that reagents are added to a master mix, rather than pipetted individually. When the per-reaction volume of reagent is < 1 µl (i.e., outside the QIAgility pipetting range), the reagent must be added to a master mix.

Reagents are set up using the “Reagent” right-hand pane. To view the “Reagent” right-hand pane, left-click on any plate or well that has “Reagent” function.

“Reagent” right-hand pane

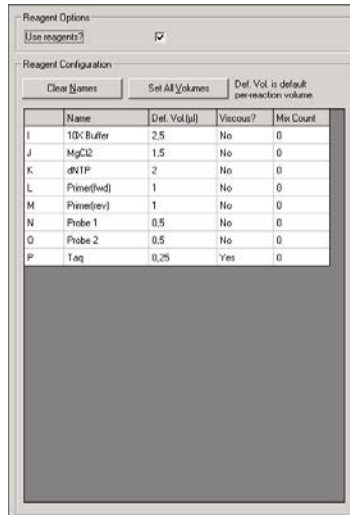

Use reagents?	Select to use reagents. Other options in the "Reagent" right-hand pane will become available.
Clear Names	Removes all reagent names from the "Reagent Configuration" table.
Set All Volumes	Click to enter a new default volume for all reagents. Click on the "OK" button to continue.
Name	Defines the name of the reagent. Names of reagents must be unique within the run.
Def. Vol.	Defines the volume of reagent to be added directly to the final reaction. If the reagent is used in a master mix, this per-reaction volume can be changed in the master mix component selection.
Viscous?	Enables a reagent to be defined as viscous. If a reagent is defined as viscous, a lower pipetting speed will be used.
Mix count	Defines the number of times the reagent will be mixed at the start of the run. This ensures that reagents are homogeneous.

Setting up reagents

1. Left-click on a plate or well with "Reagent" function in the main software window. The "Reagent" right-hand pane will appear.
2. Select "Use Reagents?". A default reagent setup will appear in the "Reagent Configuration" table
3. Enter information into the "Name", "Def. Vol.", "Viscous?" and "Mix Count" columns. To do this, left-click on the individual cells and enter the new information. For the "Viscous?" column, check the box to toggle between "Yes" and "No". Then click on the "OK" tab to update the table.

Note: If the default volume for a reagent is 0 μl , the reagent can still be used in the master mix component selection, but it will not be shown in the reaction configuration.

4. When a reagent name is entered, the associated well will appear orange on the plate on the software worktable. If the reagent name remains blank, the associated well will appear gray, and it will not be possible to use this reagent in a master mix or reaction. If a reagent is used in a master mix or reaction, it becomes more strongly colored.

5.9.4 Master Mix

Master mixes can be prepared using the QIAgility, or a premade master mix can be used. Master mixes can be added to reaction wells. By default, master mix is pipetted into a reaction well first, because it normally constitutes the greatest volume of the reaction.

To prepare a master mix using the QIAgility, individual reagents and their volume per reaction must be defined. The order in which the reagents are added to the master mix can also be defined. The software calculates the volume of reagent and diluent required to make the correct volume of master mix.

If premade master mix is used, the user only needs to define the volume of master mix per reaction.

Note: Preset master mixes can only be loaded if they consist of maximal 16 ingredients.

Note: Commercially available master mixes are not premade master mixes because they require addition of primers. A commercial master mix, and the individual primers, must be defined as reagents in the software and then combined into a master mix by the QIAgility.

By default, master mixes are located on the Master Mix Block, but they can also be located on other plates. Master mixes are set up using the "Mix" right-hand pane. To view

the “Mix” right-hand pane, left-click on any well with “Mix” function.

“Mix” right-hand pane

Source	Well	Name	Volume
	1	Water	10.75
Reagent block (standar	A	10X Buffer	2.5
Reagent block (standar	B	MgCl2	1.5
Reagent block (standar	C	dNTP	2
Reagent block (standar	D	Primer(well)	1
Reagent block (standar	E	Primer(ev)	1
Reagent block (standar	F	Probe 1	0.5
Reagent block (standar	G	Probe 2	0.5
Reagent block (standar	H	Taq (viscous)	0.25

Use Master Mix?

Select to set up a master mix. Options in the “Machine-mixed Master Mix” panel will be enabled.

Use pre-mixed Master Mix?

Select to use a premade master mix. Options in the “Pre-mixed Master Mix” panel will be enabled.

Master mix name

Defines the master mix name.

Volume per sample

Defines the volume of master mix per reaction.

No. of times to mix before dispensing:

Defines the number of times to mix before dispensing to each affected reaction plate segment.

Total reactions to prepare (if unused)	Sets the minimum volume of master mix to create if the master mix is not used in any reactions in the run. This allows the user to create a master mix without assigning it to reactions. It can be used as a premade master mix for multiple subsequent runs. Defines the volume in terms of the total number of reactions. This value is ignored when the mix is used in at least one reaction configured in the run.
Extra (if unused)?	Indicates that when master mix is made without aliquoting to reactions, the total volume should include the additional amount which is defined in the determined "Master mix extra volume" option in the "Run settings" menu. This setting is ignored when the mix is used in at least one reaction configured in the run.
Wait for confirmation after adding final ingredient?	Select to wait for confirmation after adding the final component of the master mix.
Wait for confirmation after performing final mix?	Select to wait for confirmation after performing the final mix.
No. of times to mix each reagent	Defines the number of times that the master mix will be mixed after addition of each reagent. Mixing maximizes recovery of reagent from the tip interior and equalizes the concentration of liquid remaining on the tip interior with the liquid in the mixture.

- No. of times to mix at end
Defines the number of times to mix after addition of the last reagent.
- Configure Mix
Opens the “Master Mix Component Selection” dialog box, which enables the master mix to be configured.
- Adjust Insertion Order
Opens the “Master Mix Reagent Insertion Order” dialog box, which enables the order in which reagents and diluent are added to the master mix to be adjusted.
- Load
Enables a user to select a saved master mix setup. Select the correct file and then click on the “Open” button to continue.
- Save
Select to save the master mix setup. Enter a file name and a location, then click on the “Save” button. This option is useful when the master mix is used regularly, but the sample and reaction configuration changes.

“Master Mix Component Selection” dialog box

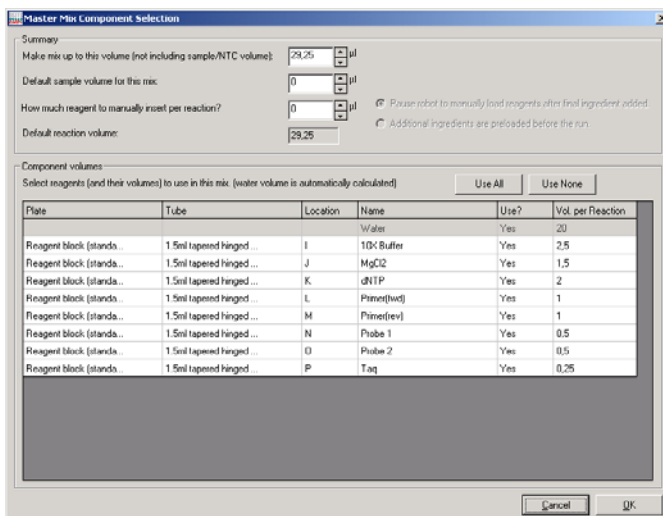

Make mix up to this volume	Defines the volume that the mix will be made up to.
Default sample volume for this mix	Defines the default sample volume for this mix.
How much reagent to manually insert per reaction?	Defines the volume of reagent that will be manually inserted into each reaction.
Default reaction volume	Defines the default reaction volume.
Pause robot to manually load reagents after final ingredient added	Instructs the instrument to pause after the final component of the master mix has been added. This allows the user time to manually add more reagents to the master mix.
Additional ingredients are preloaded before the run	Defines whether additional reagents are added to the master mix before starting the run file.
Use all	Selects all of the reagents for use in the master mix. All cells in the "Use?" column will be populated with "Yes".
Use None	Deselects all of the reagents for use in the master mix. All cells in the "Use?" column will be populated with "No".
Plate	Defines the plate type that the reagent is located in.
Tube	Defines the tube type that the reagent is located in.

Location	Defines the location of the reagent on the plate.
Name	Defines the name of the reagent.
Use?	Defines whether the reagent will be used in the master mix.
Vol. per Reaction	Defines the volume of reagent that will be used in each reaction.

Preparing a master mix for reaction setup

1. Left-click on the well in the Master Mix Block that will contain the master mix. The "Mix" right-hand pane will appear.
2. Select "Use Master Mix?". Enter a name for the master mix in the "Master Mix name" field.
3. Define the "No. of times to mix each reagent", and the "No. of times to mix at end".
4. If desired, select "Wait for confirmation after adding final ingredient?" and "Wait for confirmation after performing final mix?". These options are useful if extra reagents need to be manually added to the master mix, or if the master mix needs to be vortexed.
5. Click on the "Configure Mix" button. The "Master Mix Component Selection" window will appear.
6. Enter the master mix volume per reaction.
7. Enter the default sample volume. The total reaction volume will then be calculated and displayed. The total reaction volume cannot be edited.
8. Reagents are listed in the "Component volumes" panel. To add reagents, left-click in a cell in the "Use?" column, then check the box to select "Yes", and then click on the "OK" tab. Alternatively, click on the "Use all" or "Use none" buttons to select all of the reagents or to deselect all of the reagents.
9. The default volumes in the "Vol. per Reaction" column are the volumes that have been defined in the

“Reagent” right-hand pane. To change these volumes, left-click on the corresponding cell in the “Vol. per Reaction” and enter a new volume. Click on the “OK” tab. The diluent volume is automatically adjusted to make up the difference between the combined reagent volume and the volume of master mix per reaction.

Note: Diluent will always be added, unless the reagent volumes add up to the desired master mix volume.

10. Click on the “OK” button to continue. Added reagents will be listed in the “Machine-mixed Master Mix” panel, in the order in which they will be added to the master mix.
11. Click on the “Close” button. The corresponding well in the Master Mix Block will now be colored yellow.
12. To prepare another master mix, left-click on a different well in the Master Mix Block and repeat the above procedure.

Changing the reagent insertion order

Diluent is usually the component with the largest volume and is therefore, by default, added to the master mix first. However, the insertion order can be adjusted.

Note: It is recommended that any reagents that contain detergent are added last. This limits the risk of froth forming on the surface of the master mix.

To change the reagent insertion order:

1. Click on the “Adjust Insertion Order” button in the “Mix” right-hand pane.
2. The “Master Mix Reagent Insertion Order” dialog box will appear.

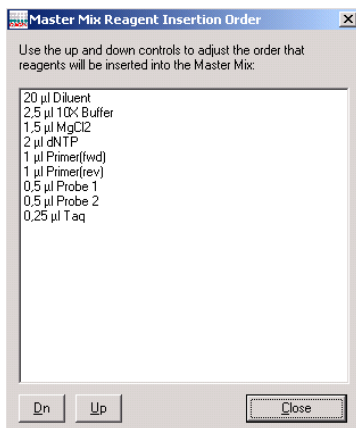

- | | |
|-------|---|
| Dn | Moves the selected reagent down the list. |
| Up | Moves the selected reagent up the list. |
| Close | Closes the "Master Mix Reagent Insertion Order" dialog box. |

3. Left-click on a reagent in the list. Use the "Dn" and "Up" buttons to adjust the order of the reagents.
4. Click on the "Close" button.

Preparing master mix without reaction setup

Master mixes can be prepared without being assigned to a reaction. To do this:

1. Set up a master mix, as described in the "Preparing a master mix for reaction setup" section.
2. Define the total number of reactions to prepare, using the "Total reactions to prepare (if unused)" option.
3. If extra volume is required, select "Extra (if unused)?".

Setting up a premade master mix

1. Left-click on a well in the Master Mix Block. The "Mix" right-hand pane will appear.
2. Select "Use Master Mix?", and then select "Use pre-mixed Master Mix?".

3. Enter a name for the master mix in the “Master Mix name” field.
4. Enter the “Volume per sample” and the “Number of times to mix before use”. The corresponding well in the Master Mix Block will now be colored green.

Loading a saved master mix setup

1. Click on the “Load” button in the “Machine-mixed Master Mix” panel.

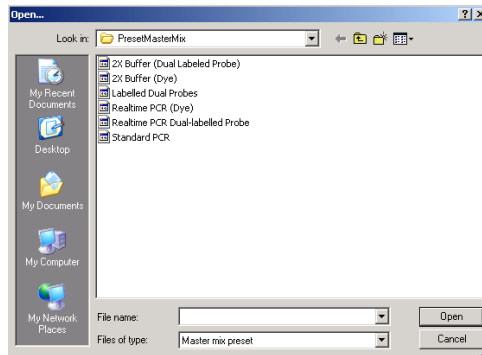

2. Select a file and then click on the “Open” button.
3. The “Reagent Selector” window will appear. The reagents are listed in the “Reagents” panel in white boxes.

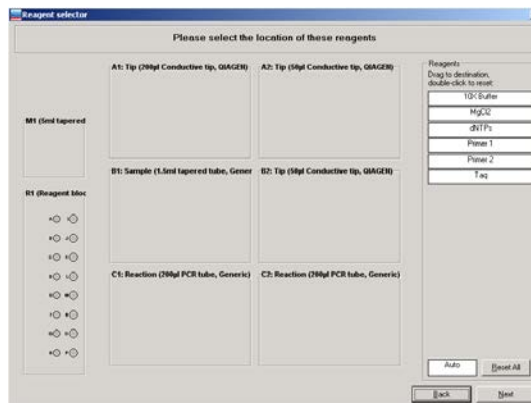

4. To assign a reagent to a location, left-click on a reagent and drag it to the desired well on a reagent plate. Do

this for all the reagents. The process of assigning reagents to locations can be intermitted and continued later. If the reagent locations do not matter, click and drag the "Auto" white box to the desired reagent segment. Reagents will automatically be assigned to a location. Selected wells will be highlighted red.

Note: Some reagent locations may already be in use by previously defined reagents. If the name of the reagent used in the saved master mix setup is identical to reagents already set up, these will automatically be allocated to those positions.

5. To reset the location of any reagent, double-click on a reagent in the list, then left-click and drag again. Alternatively, click on the "Reset All" button to clear all reagent locations, other than those that were defined upon entering the screen.
6. Click the "OK" button to continue.

Copying a master mix

When a master mix has been setup using the right-hand pane, the master mix can be copied to a different well which also has "Mix" function.

To copy a master mix:

1. Right-click on a well which contains a master mix.
2. The plate operations menu will appear.

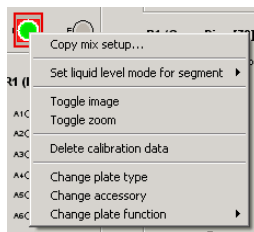

3. Select "Copy mix setup". The "Copy Mix Setup" dialog box will open.

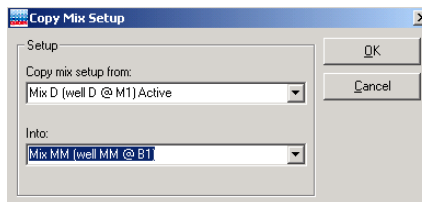

4. The "Into" field lists wells which have "Mix" function". Select the well into which the master mix will be copied.
5. Click on the "OK" button. The master mix will now be copied into the selected well.

5.9.5 Samples

To be used in reactions, samples must be organized into groups called "Sample Banks". Each sample can be assigned a name, an ID (e.g., a barcode) and a starting concentration. This information can be imported from an external file (e.g., an Excel® spreadsheet).

Samples in the same "Sample Bank" are treated identically during a reaction. A sample may be present in more than one sample bank. Sample banks can be continuous groups of wells, or a combination of individual wells, but they cannot span multiple plates or plate segments.

See Section 5.9.7 for more detailed information about importing and exporting data into the "Sample" right-hand pane.

Diluent can be used as a sample for nontemplate controls. Standards are treated in the same way as samples.

Sample banks can be modified or created using the "Sample" right-hand pane. To view the "Sample" right-hand pane, left-click on a "Sample" well.

“Sample” right-hand pane

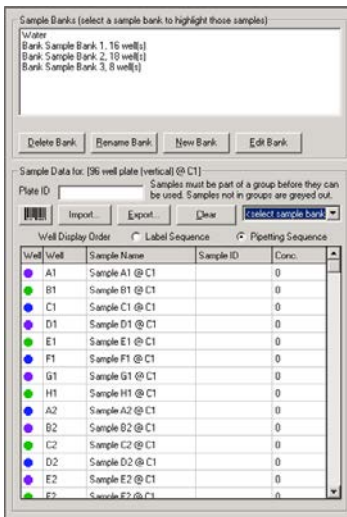

- Delete Bank** Deletes the selected sample bank. Deleting a sample bank will not affect sample names, sample IDs, or concentrations.
- Rename Bank** Opens a dialog box in which the sample bank name can be changed. Click on the “OK” button to continue.
- New Bank** Displays the “Update Sample Bank” dialog box, which enables a new sample bank to be created. See Section 5.8.1.
- Edit Bank** Displays the “Update Sample Bank” dialog box, which enables an existing sample bank to be modified. See Section 5.8.1.
- Plate ID** Enables a plate ID to be entered. This can be entered manually or using a bar code reader.



	Opens the “Barcode Entry” dialog box, which enables interactive input of sample ID bar codes.
Import	Opens the “Import Well Data” dialog box, which enables sample data to be imported from a file.
Export	Opens the “Export Samples” dialog box, which enables sample data to be exported to another file.
Clear	Deletes any user-assigned sample names, sample IDs and concentration values. Sample IDs are reset to ‘blank’, and concentrations are reset to “0”.
<select sample bank>	A sample bank can be selected from the drop-down menu.
Well Display Order	This determines the sequence in which wells are displayed in the sample data grid (i.e. “Label Sequence” or “Pipetting Sequence”). Each plate type has a specific ‘pipetting’ order and specific ‘label’ order. Where these are different (e.g. vertical pipetting order and horizontal label order), the sequence in which wells are listed in the grid changes according to the well display order selection. This function is useful, for example, when it is convenient to dispense liquids by column (vertical pipette order), but to export the data by row (horizontal label order).
Copy all	Select to copy the “Sample Data” list. The data can be pasted into an Excel file.
Paste to current cell	Pastes a list of “Yes”/“No” values from a spreadsheet into the “Sample Data” column.

Row height	Enables row height to be adjusted. A submenu will appear. Select “Grow” to increase the row height, or select “Shrink” to decrease the row height.
Export	Select to export the “Sample Data” list to another file. A submenu will appear. Select either “Export to CSV” or “Export to Excel”.

Managing sample banks via the “Sample Banks” panel

The “Sample Banks” panel, located at the top of the “Sample” right-hand pane, displays a list of current “Sample Banks”.

Click on the “New Bank”, or “Edit Bank” buttons to open the “Update Sample Bank” dialog box. Sample banks can be managed via this dialog box. See Section 5.8.1 for more detailed information about how to do this. Alternatively, double-click on a sample bank to view the “Update Sample Bank” dialog box.

Left-click on a sample bank to view the associated sample list in the “Sample Data” panel.

Modifying sample banks via the “Sample Data” panel

1. Select the sample bank to be edited from the “<select sample bank>” drop-down menu in the “Sample Data” panel.
2. An additional column will appear in the sample list.
3. To add or remove a sample from a sample bank, left-click on a cell within this column. A checkbox will appear in the cell.
4. To add a sample to the sample bank list, check the box to change the contents of the cell to “Yes”. To remove a sample from the sample bank list, check the box to change the contents of the cell to “No”.

Note: Samples that are assigned to the selected sample bank are highlighted white, and samples that are not

assigned to the selected sample bank are displayed in gray.

Alternatively, it is possible to copy and paste a column of "Yes"/"No" values from a spreadsheet. Right-click in the cell of the desired starting row, then select "Paste to current cell".

Samples are given default sample names, based on their position in the sample plate. To change the sample name, to input a sample ID, or to input a starting concentration, left-click on a cell in the "Sample Name", "Sample ID", or "Conc." column. Directly enter the desired information.

5.9.6 Reactions

Pipetting operations in a given run are defined by a "Reaction List". Reaction lists can be created and modified using the "Reaction" right-hand pane.

To view the "Reaction" right-hand pane, left-click on a reaction plate. The buttons located below the "Reaction List" can be used to configure the list. The "Reaction Data" panel lists the wells and contents of the selected reaction plate. It also enables reaction data to be imported from a spreadsheet and exported to another file.

See Section 5.9.7 for more detailed information about importing and exporting information into the "Reaction" right-hand pane.

“Reaction” right-hand pane

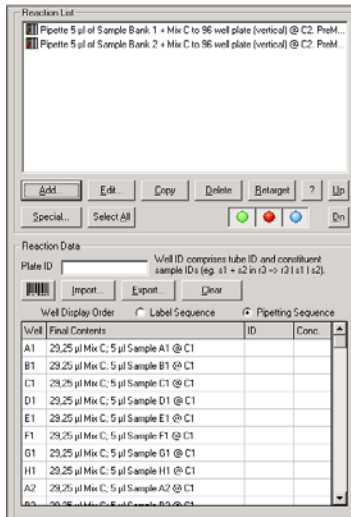

- Add** Opens the “Reaction Configuration” dialog box. Enables setup of a new PCR reaction.
- Edit** Opens the “Reaction Configuration” dialog box. Enables a reaction to be edited. Alternatively, double-click on a reaction to open the “Reaction Configuration” dialog box.
- Copy** Copies selected reaction. Left-click on a reaction in the “Reaction List” and then click on the “Copy” button. If there is more than one reaction in the list, a submenu will appear. Select “Copy in-place?”, “Copy to end of list?” or “Cancel”.
- Delete** Deletes selected reactions. To delete more than one reaction, hold down the “Shift” or “Ctrl” key, left-click on reactions in the “Reaction List” to select them, and then click on the “Delete” button.





Retarget	Enables a reaction to be retargeted to a different reaction plate. Left-click on the new reaction plate to select it, then left-click on a reaction in the "Reaction List", and then click on the "Retarget" button. A message box will appear, click on the "Yes" button to continue.
?	Displays a summary of the selected reaction.
Up/Dn	Modifies the reaction order. Left-click on the reaction to be changed in the "Reaction List". Hold down the "Shift" key to select multiple reactions. Click on the "Up" or "Down" buttons to move the selected reaction(s) up or down in the "Reaction List".
Special	Enables a "Special" reaction to be set up and added to the "Reaction List".
Select All	Selects all of the reactions in the "Reaction List".
	Highlights master mixes and reagents, which are involved in a selected reaction, in green. Click on the icon again to remove the highlights.
	Highlights diluent, standards and sample banks, which are involved in a selected reaction, in orange. Click on the icon again to remove the highlights.
	Highlights destination reaction wells, which are involved in a selected reaction, in blue. Click on the icon again to remove the highlights.

Plate ID	Enables a plate ID to be entered. This can be entered manually or using a bar code reader.
	Enables interactive input of reaction ID bar codes. Click to open the "Barcode Entry" dialog box.
Import	Enables reaction data to be imported. Click to open the "Import Well Data" dialog box.
Export	Enables reaction data to be exported. Click to open the "Export Reaction Info" dialog box.
Clear	Clears any user-assigned reaction IDs and concentration values.
Well Display Order	This determines the sequence in which wells are displayed in the sample data grid (i.e., "Label Sequence" or "Pipetting Sequence"). Each plate type has a specific 'pipetting' order and specific 'label' order. Where these are different (e.g., vertical pipetting order and horizontal label order), the sequence in which wells are listed in the grid changes according to the well display order selection. This function is useful, for example, when it is convenient to dispense liquids by column (vertical pipetting order), but to export the data by row (horizontal label order).
Copy all	Select to copy the "Reaction Data" list. The data can be pasted into an Excel file.
Paste to current cell	Pastes data from the system clipboard (e.g., a list of "Yes"/"No" values from a spreadsheet) into the "Reaction Data" column.

Row height	Select to adjust row height. A submenu will appear. Select "Grow" to increase the row height, and select "Shrink" to decrease the row height.
Export	Select to export the "Reaction Data" list. A submenu will appear. Select either "Export to CSV" or "Export to Excel."
Assign ID's	Enables groups of reactions to be assigned the same value in the "ID" column. Left-click and drag to select a group of cells. Right-click on the selection and select "Assign ID's".
Set Concentrations	Enables groups of reactions to be assigned the same value in the "Conc" column. Left-click and drag to select a group of cells. Right-click on the selection and select "Set Concentrations".

Well

The "Well" column indicates the label of the reaction well, as determined by the plate type.

Final Contents

The "Final Contents" column describes the final composition of the liquid in the well, as determined by a complete simulation of the run.

Note: When pipetting operations add liquids to a well and later remove them, the final well contents may be empty. This is different to the data presented when hovering the cursor over a reaction well on the software worktable. In this case, only liquids added to the well are shown.

ID

The "ID" column shows a combination of identifiers associated with each reaction well. This includes a "Reaction

ID" which can be assigned as a fixed attribute of the well. It also includes a list of the IDs of samples present in the well on completion of the run, as determined by simulation of the pipetting operations. The "label" ID and "contents" IDs are combined together as a 'Full ID' using a '|' character as separator, with the user-assigned "label" ID listed first.

Concentration

The "Concentration" column displays a concentration value associated with a reaction well. When a reaction contains just one sample (or standard) and the starting concentration of that sample has been defined, the final concentration of that sample in the reaction well is displayed. When a reaction contains more than one sample, no final concentration value can be calculated, so no value is displayed. If desired, the user can assign a concentration value to the reaction well.

User-assigned concentrations are shown in blue. This is useful for dilution of samples, or stock wells, which are supplied initially in reaction plates. If a user-assigned concentration is entered for a well which also has a valid calculated concentration, the user-assigned value is shown in red, to indicate that it is overriding the software-calculated value.

Note: Concentration values are assumed to be entered in a single unit common to all values in the run. The unit itself can be defined as needed for the application (see Section 5.6.5).

Creating sample banks from target wells

Selecting a liquid handling operation in the "Reaction List" region of the right hand pane highlights the destination wells associated with the operation when the blue button below the list is activated. Where the selected liquid handling operation supports the action, the highlighted wells can be directly entered into a sample bank as follows. Right-click the liquid handling operation to show the "Create Sample Bank from Target wells" menu item. Select

this item to present the “Update Sample Bank” form. Now enter a bank name as described in Section 5.8.1 and save the updated sample bank.

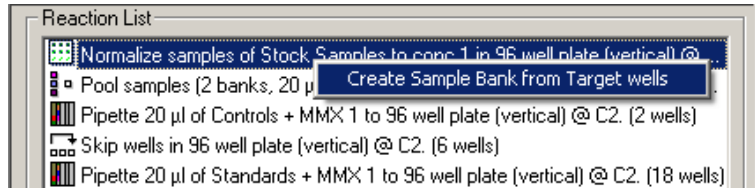

This function increases convenience when making a series of liquid handling operations in which the source wells for a given operation correspond to the target wells constructed by a predecessor operation.

“Reaction Configuration” dialog box

To open the “Reaction Configuration” dialog box, click on the “Add” button from the “Reaction” right-hand pane.

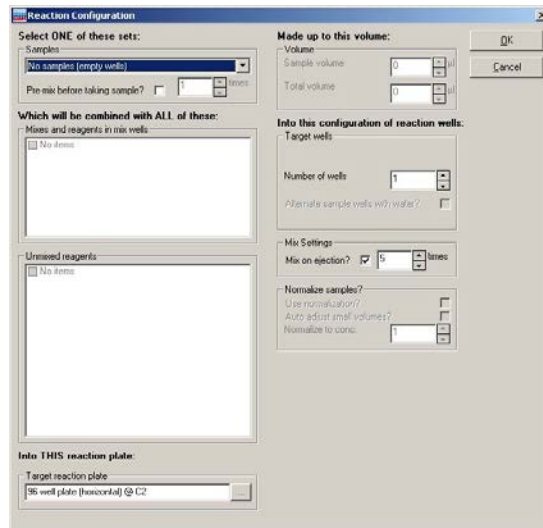

When the option “Allow multiple reagent volumes” is activated in the “Run Settings” menu (see section 5.6.6) the “Reaction Configuration” dialog box is displayed with the advanced reagents view:

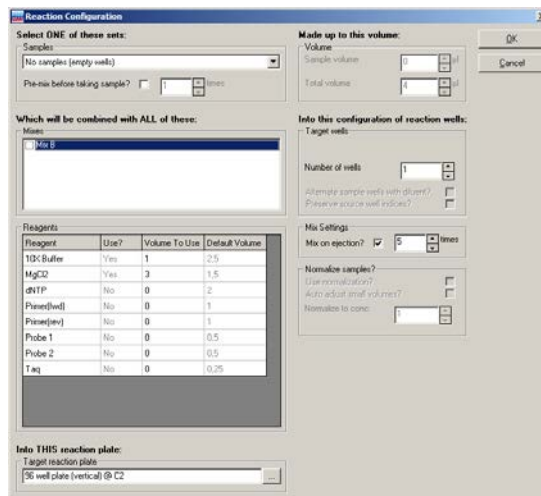

- Samples

Allows selection of a sample bank from the drop-down menu.
- Pre-mix before taking sample?

Select to premix samples, and then define the number of mixes. This function instructs the instrument to mix each sample of the sample bank as it is aspirated for transfer to the reaction well.
- Mixes and reagents in mix wells

Defines the master mixes that will be added to the reaction. All wells that have "Mix" function, and that have been assigned a per-reaction volume, will be listed. Selected master mixes will be added to the reaction.
- Unmixed reagents (Simple reagents view)

Defines the unmixed reagents that will be added to the reaction. All named reagents which have been assigned a per-reaction volume will be listed. The default volume of selected reagents will be added to the reaction.

Reagents (Advanced reagents View)	Shows a table of all available reagents on the worktable. By entering a volume in the column "Volume to use" the given volume of the selected reagent is added to the reaction.
Target reaction plate	Click on the  button to open the "Plate/well Selector" screen. This screen allows the user to select the target reaction plate and well.
Sample volume	Defines the volume of sample to be added to the reactions. When "Use normalization?" is selected, this option defines the target volume for normalized samples in the reactions. An initial value is automatically set when the operation includes a master mix configured with default sample volume. A sample volume of zero is permitted.
Total volume	Defines the per-reaction total volume. The "Total volume" is automatically calculated, based on the sample, reagent, and master mix volumes.
Replicates	Defines the number of replicates to be performed for each sample bank.
Number of wells	Defines the total number of wells. This number is automatically calculated, based on the number of samples in the sample bank and the number of replicates.
Alternate sample wells with diluent?	When constructing reactions, this option instructs the instrument to alternate sample wells with diluent. When selected, the operation prepares successive reactions using a sample from the bank, then diluent, then the next sample from the bank, and so on.

Preserve source well indices?	This function is visible only when enabled in the "Advanced Settings" menu in the "Options" menu. When selected, the reaction constructed for each sample is placed into the same relative location from the start of the reaction plate as the sample from the start of the sample plate, determined according to pipetting order.
Mix on ejection?	Instructs the instrument to perform a mix cycle upon ejecting the sample and defines the number of mix cycles to perform. Mixing is only performed when the final reaction component is added, and only when there is more than 1 component in the reaction.
Use normalization?	Instructs the instrument to normalize sample concentrations.
Auto Adjust small Volumes	Instructs the instrument to round up sample volumes that are less than the minimum volume that can be pipetted (i.e., 1 μ l), to the minimum volume (i.e., 1 μ l). Where the operation would require less than the pipettable volume of diluent, no diluent is transferred, only sample is moved. In all such cases, the final volume is preserved, but the desired final concentration is not achieved.
Normalize to conc.	Defines the concentration to which samples will be normalized. This excludes the contribution that other reagents and master mix make to the reaction.

Setting up a reaction list

Note: If the total number of reactions configured on one plate exceeds the number of reaction wells a warning will

appear. This warning must be resolved before the run can be started.

1. Left-click on a plate with "Reaction" function.
2. The "Reaction" right-hand pane will appear.
3. Click on the "Add" button.
4. Select a sample bank from the drop-down menu in the "Samples" panel.

Note: Only one sample bank can be selected per reaction.

5. If desired, select "Pre-mix before taking sample?" and enter the number of times to mix.
6. Select the components of the reaction. Available master mixes are listed in the "Mixes and reagents in mix wells" panel, and available unmixed reagents are listed in the "Unmixed reagents" panel. Left-click in the boxes next to the required components to select them. A tick will appear next to the components which have been selected.
7. Click on the  button to select the target reaction plate. The "Plate/well Selector" window, which displays a schematic of the worktable setup, will appear.

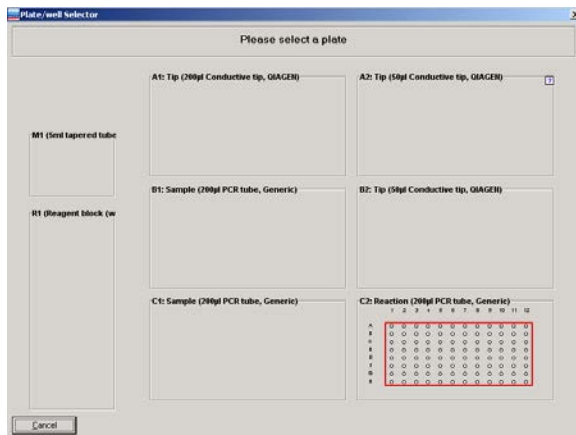

8. Left-click on a reaction plate to select it. The "Reaction Configuration" dialog box will reappear.

Note: If there is only one “Reaction” plate, this plate will be selected by default. To return to the “Reaction Configuration” dialog box, left-click on the selected plate.

9. Define the options in the “Volume”, “Target wells”, “Mix Settings”, and “Normalize samples?” panels as required.
10. Click on the “OK” button to return to the main software window.

Note: See Section 5.10.5 for details about how to check the reaction setup.

Using “Special” options in the reaction setup

A number of “Special” options are available from the “Reaction” right-hand pane. To view these options, left-click on the “Special” button.

Note: It is recommended that reactions that include “Special” options are simulated in “Virtual Mode” before starting an actual run.

Many of the “Special” operations allow the user to select the starting well. In these cases, there is a risk of mixing samples. A warning will be displayed at the start of the run if sample will be added to a well that already contains another sample.

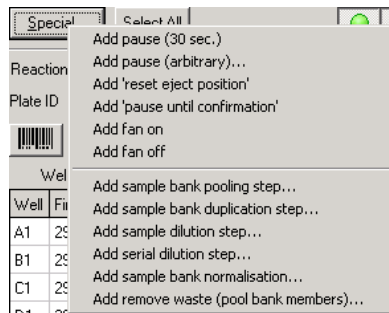

Add pause (30 sec.) Adds a 30 second pause to the reaction list.

Add pause (arbitrary) Adds a pause of defined length to the reaction list.

Add 'reset eject position'	Configures the instrument to start pipetting into a reaction plate from its first well, typically well A1. This can be useful for pooling sample banks. There is no contamination of source sample banks.
Add 'pause until confirmation'	<p>Pauses the instrument for an unlimited period of time. A dialog box will appear. If desired, enter a message that will appear on the screen when the instrument pauses. Then click on "OK" to add the command to the reaction list.</p> <p>When the instrument pauses, user intervention is required to continue the reaction setup. Click on the "OK" button to continue.</p>
Add fan on	Turns the HEPA filter on.
Add fan off	Turns the HEPA filter off.
Add sample bank pooling step	Opens the "Sample Bank Pooling" dialog box, which enables sample banks to be pooled. The user can control tip usage during the pipetting operation.
Add sample bank duplication step	Opens the "Bank Duplication" dialog box, which enables copying of sample banks. The user can control tip usage.
Add sample dilution step	Opens the "Sample Dilution" dialog box, which enables a sample bank to be diluted by addition of varying quantities of diluent and sample.
Add serial dilution step	Enables the user to perform a serial dilution. The user can select which dilutions to add to reactions.

Add sample bank normalization	Enables the user to prepare a stock plate of normalized samples and a working plate using a minimal number of tips. If a minimal number of tips is used, the sample plate will be contaminated with diluent.
Add remove waste (pool bank members)	Enables a reaction plate to be specified as a waste receptacle. All samples in a sample bank can be moved to a single well.

Adding a pause into the reaction list

It can be useful to introduce a pause into the reaction list if an incubation time is required between pipetting operations.

Note: Pauses are processed during sample processing only after master mix and reagents have been aliquoted to reactions.

To introduce a 30 second pause:

1. Left-click on a "Reaction" plate.
2. The "Reaction" right-hand pane will appear.
3. Click on the "Special" button.
4. Select "Add pause (30 sec.)".
5. The reaction list will be updated.

To introduce a pause of defined length:

1. Left-click on a "Reaction" plate.
2. The "Reaction" right-hand pane will appear.
3. Click on the "Special" button.
4. Select "Add pause (arbitrary)".
5. The "Configure Pause" dialog box will appear.

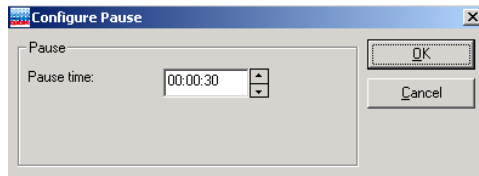

6. Adjust the pause time using the arrows (h:min:s).
Note: The "Pause time" can be between 1 s and 96 h.
7. Click on the "OK" button. The reaction list will be updated.

To introduce a pause during which a message is displayed that waits for user confirmation:

1. Left-click on a "Reaction" plate.
2. The "Reaction" right-hand pane will appear.
3. Click on the "Special" button.
4. Select "Add 'pause until confirmation'".
5. The "Configure Pause" dialog box will appear.

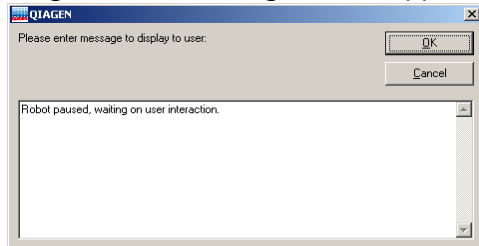

6. Enter the text to be confirmed by the user.
7. Click on the "OK" button. The reaction list will be updated.

Resetting the ejection position

To reset the ejection position, proceed as follows:

1. Left-click on a "Reaction" plate.
2. The "Reaction" right-hand pane will appear.
3. Click on the "Special" button.
4. Select "Add 'reset ejection position'".
5. The pipetting head will move to the first position of the current plate segment when performing this step.

Add sample bank pooling step

This function combines different sample banks, pooling them into reactions. This can generate significant tip savings, but may result in contamination of sample banks, depending on the tip usage configured for the operation.

Just 96 tips can be used to pool 3 x 96-well sample plates, each defined as separate sample banks. In comparison, 288 tips would be used for the same operation when using "Add 'reset eject position'".

When using the "Add sample bank pooling step" option with the default tip usage setting, the instrument picks up a tip, takes an aliquot from the first plate, takes an aliquot from the second plate, and then takes an aliquot from the third plate. The three samples are then pipetted into the reaction plate. The second and third sample plates are therefore contaminated. In contrast, there is no sample plate contamination when using "Add 'reset eject position'".

To set up sample bank pooling using the "Add sample bank pooling step" option:

1. Left-click on a "Reaction" plate.
2. The "Reaction" right-hand pane will appear.
3. Click on the "Special" button.
4. Select "Add sample bank pooling step".
5. The "Sample Pooling" dialog box will open.

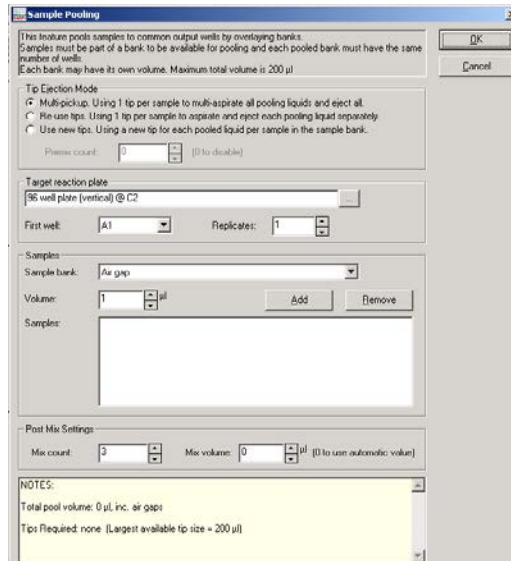

- Multi-pickup** Instructs the instrument to use a single tip to multi-aspirate and to eject all pooling liquids. This allows a total volume up to the volume of the largest tip size on the worktable to be pooled. Sample contamination may occur.
- Re-use tips** Instructs the instrument to use a single tip to aspirate and eject each pooling liquid separately. This allows pooling of component volumes, each up to the largest tip size on the worktable. Sample contamination may occur.
- Use new tips** Instructs the instrument to use a new tip for each pooled liquid per sample in the sample bank. This option avoids contamination of sample wells, but tip consumption is higher than with other options.

Premix count	Defines the number of mixes to be performed when aspirating samples to be pooled. This option is only available when individual samples are moved separately.
	Opens the "Plate/well Selector" screen, which enables the target reaction plate to be selected.
First well	Defines the first well of the reaction plate into which the sample bank will be pooled.
Replicates	Defines the number of replicates.
Sample bank	Defines a component sample bank to be added to the target reaction wells in a pooling step.
Volume	Defines the volume of each sample in the sample bank to be added during a pooling step.
Add	Adds the defined pooling step to the "Samples" list.
Remove	Removes the defined pooling step from the "Samples" list.
Samples	Defines the list of pooling steps.
Mix count	Defines the number of mix operations to be performed when the final component is added to each pooled reaction.
Mix volume	Specifies the volume to be aspirated and ejected during the final mixing, when the mix count is greater than 0. A value of 0 indicates that the software should choose an appropriate, recommended value.

6. Select "Tip Ejection Mode" — "Multi-pickup", "Re-use tips", or "Use new tips".

7. If "Re-use tips" or "Use new tips" were selected, define the "Premix" count.
8. Click on the  button to select the target reaction plate. The "Plate/well Selector" window will appear.
9. Left-click on a reaction plate to select it. The "Sample Pooling" dialog box will reappear.
Note: If there is only one "Reaction" plate, this plate will be selected by default. Left-click on the selected plate to return to the "Sample Pooling" dialog box.
10. Define the "First well" and the number of "Replicates".
11. Select a sample bank to be pooled from the "Sample bank" drop-down menu.
12. Define the "Volume" to be added and then click on the "Add" button.
13. When "Multi-pickup" is selected, it is recommended to select "Air gap" from the drop-down menu in the "Samples" panel.
14. Define the "Volume" to be added and then click on the "Add" button.
15. Repeat steps 11–14 for the remaining sample banks that will be pooled.
16. Define the "Mix count:" and the "Mix volume:"
17. Click on the "OK" button to return to the main software window. The "Reaction List" will be updated with the sample bank pooling step.

Add sample bank duplication step

If a sample bank of 8 samples was copied 5 times using standard reaction steps, 40 tips would be required. When the "Add sample bank duplication step" option is used, only 8 tips are required for this operation.

To copy a sample bank:

1. Left-click on a "Reaction" plate.
2. The "Reaction" right-hand pane will appear.
3. Click on the "Special" button.
4. Select "Add sample bank duplication step".

5. The “Bank Duplication” dialog box will appear.

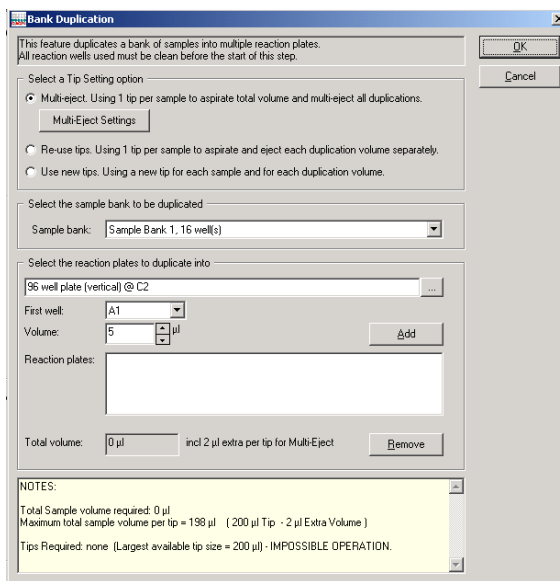

Multi-eject Instructs the instrument to use a single tip per sample to aspirate the total volume and to multi-eject all duplications.

Multi-Eject Settings Opens the “MULTI-EJECT” dialog box, which enables configuration of multi-eject options. See Section 5.6.12 for more details about how to configure these options.

Re-use tips Instructs the instrument to use a single tip per sample to aspirate and eject each duplication volume separately.

Use new tips Instructs the instrument to use a new tip for each sample and each duplication volume.

Sample bank Defines the sample bank to be copied.

	Opens the “Plate/well Selector” screen, which enables the target reaction plate to be selected.
First well	Defines the first well of the reaction plate into which the sample bank will be copied.
Volume	Defines the volume of the sample bank that will be taken.
Add	Adds the duplication step to the “Reaction plates” list.
Remove	Removes a duplication step from the “Reaction plates” list.
Reaction plates	Lists the duplication steps.
Total volume	Defines the total volume, which includes an extra volume if “Multi-eject” was selected. The extra volume is dependent on the settings.

6. Select the “Tip Ejection Mode” — “Multi-pickup”, “Re-use tips”, or “Use new tips”.
7. If “Multi-eject” was selected, the “Multi-Eject Settings” option will be available. See Section 5.6.12 for more details about how to configure multi-eject options.
8. Select the sample bank to be copied from the drop-down menu.
9. Click on the  button to select the target reaction plate. The “Plate/well Selector” window will appear.
10. Left-click on a reaction plate to select it. The “Bank Duplication” dialog box will reappear.
Note: If there is only one “Reaction” plate, this plate will be selected by default. Left-click on the selected plate to return to the “Bank Duplication” dialog box.
11. Define the “First well” and the “Volume”.
12. Click on the “Add” button to configure the first sample bank copy.

13. If required, repeat steps 9–12 to configure more copies. The software will automatically calculate the “Total Volume”.
Note: To remove a copy, left-click on a copy in the “Reaction plates” list, and then click on the “Remove” button.
14. Click on the “OK” button to return to the main software window. The “Reaction List” will be updated with the sample bank duplication step.

Add sample dilution step

This function performs dilutions of a bank of samples with a diluent reagent. Each dilution in the series is specified by a pair of volumes that describe the amount of sample and amount of diluent to be combined in the reaction. By default, dilutions of the sample are performed with a single tip, to transfer the sample to target reactions. A different tip is used for transferring the diluent to target reactions, thereby minimizing tip usage.

1. Left-click on a “Reaction” plate.
2. The “Reaction” right-hand pane will appear.
3. Click on the “Special” button.
4. Select “Add sample dilution step”.
5. The “Sample Dilution” dialog box will appear.

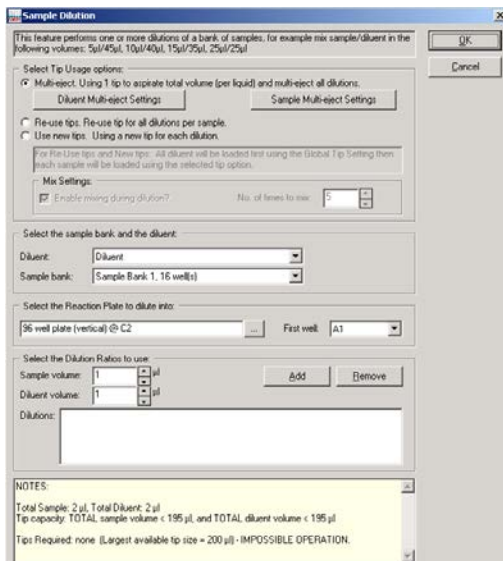

Multi-eject Instructs the instrument to use 1 tip to aspirate the total volume of sample and to use a different tip to aspirate the total volume of diluent. The instrument will then multi-eject to the target wells to construct all dilutions.

Diluent Multi-eject Settings Opens the “MULTI-EJECT” dialog box, which enables configuration of diluent multi-eject options. See Section 5.6.12 for more details about how to configure multi-eject settings.

Sample Multi-eject Settings Opens the “MULTI-EJECT” dialog box, which enables configuration of sample multi-eject options. See Section 5.6.12 for more details about how to configure multi-eject options.

Re-use tips Instructs the instrument to reuse a single tip for all dilutions per sample.

Use new tips	Instructs the instrument to use a new tip for each dilution.
Enable mixing during dilution?	Enables mixing during dilution.
No. times to mix	Defines the number of times to mix.
Diluent	Defines the diluent to be used for dilution.
Sample bank	Defines the sample bank to be used in the dilution.
	Opens the "Plate/well Selector" screen, which enables the target reaction plate to be selected.
First well	Defines the first well of the reaction plate into which the dilution will be targeted.
Sample volume	Defines the volume of the sample bank that will be used in a dilution.
Diluent volume	Defines the volume of diluent that will be used in a dilution.
Add	Adds the dilution step to the "Dilutions" list.
Remove	Removes a dilution step from the "Reaction plates" list.

6. Select the "Tip Ejection Mode" — "Multi-pickup", "Reuse tips", or "Use new tips".

Note: If "Multi-eject" was selected, the "Diluent Multi-eject Settings" and "Sample Multi-eject Settings" options will be available. These options can be used to configure the multi-eject options of the sample and diluent. See Section 5.6.12 for more details about how to configure multi-eject options.

7. Select the diluent and the sample bank that will be used in the dilution from the drop-down menus.
8. Click on the  button to select the target reaction plate. The "Plate/well Selector" window will appear.
9. Left-click on a reaction plate to select it. The "Sample Dilution" dialog box will reappear.
Note: If there is only one "Reaction" plate, this plate will be selected by default. Left-click on the selected plate to return to the "Sample Dilution" dialog box.
10. Define the "First well".
11. Define the "Sample volume" and the "Diluent volume", and then click on the "Add" button.
12. If required, repeat steps 8–12 to configure more dilutions.
Note: To remove a copy, left-click on a copy in the "Reaction plates" list, and then click on the "Remove" button.
13. Click on the "OK" button to return to the main software window. The "Reaction List" will be updated with the sample dilution step.

Add serial dilution step

1. Create a sample bank that contains 1 well. See Section 5.8.1 for details about how to do this.
2. Left-click on a "Reaction" plate.
3. The "Reaction" right-hand pane will appear.
4. Click on the "Special" button.
5. Select "Add serial dilution step".
6. The "Serial Dilution" dialog box will appear.

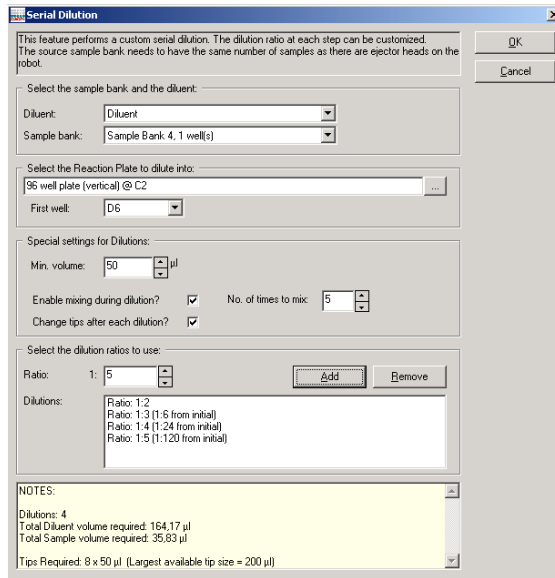

- Diluent** Defines the diluent to be used in the serial dilution. This sample bank must contain only one sample.
- Sample bank** Defines the sample bank to be used in the serial dilution
-  Opens the "Plate/well Selector" screen, which enables the target reaction plate to be selected.
- First well** Defines the first well of the reaction plate into which the serial dilution will be targeted.
- Min. volume** Defines the minimum total volume for each dilution in the series.
- Enable mixing during dilution?** Instructs the instrument to mix during dilution.

Change tips after each dilution?	Instructs the instrument to change tips after each dilution. When selected, a new tip is used for aliquoting each diluent volume and each dilution sample. When not selected, a single tip is used to aliquot diluent, and a new tip is used to aliquot the dilution samples.
No. of times to mix	Defines the number of times to mix.
Ratio	Defines the sample:diluent ratio for a given dilution.
Add	Adds a given dilution to the "Dilutions" list.
Remove	Removes a selected dilution from the "Dilutions" list.

7. Select the diluent and the sample bank to be used in the serial dilution from the drop-down menus.
8. Click on the  button to select the target reaction plate. The "Plate/well Selector" window will appear.
9. Left-click on a reaction plate to select it. The "Serial Dilution" dialog box will re-appear.
Note: If there is only one "Reaction" plate, this plate will be selected by default. To return to the "Serial Dilution" dialog box, left-click on the selected plate.
10. Define the options as required in the "Special settings for Dilutions" panel.
11. Define a series of dilution ratios. To do this, enter a ratio and then click on the "Add" button. Repeat this for every dilution ratio of the series.
Note: To remove a dilution, left-click on a copy in the "Dilutions" list, and then click on the "Remove" button.
12. Click on the "OK" button to return to the main software window. The dilutions will be added to the "Reaction List".

Add sample bank normalization

This function equalizes the concentrations of the wells of a sample bank by dilution with a specified diluent. The normalized samples are prepared in separate reaction wells.

1. Left-click on a "Reaction" plate.
2. The "Reaction" right-hand pane will appear.
3. Click on the "Special" button.
4. Select "Add sample bank normalization".
5. The "Sample Normalization" dialog box will appear.

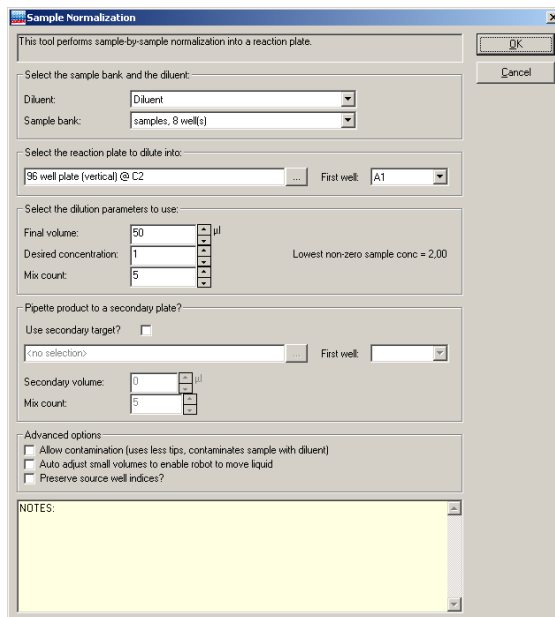

Diluent Defines the diluent to be used for the sample normalization.

Sample bank Defines the sample bank to be used for the sample normalization.

	<p>Opens the “Plate/well Selector” screen, which enables the target reaction plate and the secondary target reaction plate to be selected.</p>
First well	<p>Defines the first well of the reaction plate into which the sample normalization will be targeted.</p>
Final volume	<p>Defines the final volume.</p>
Desired concentration	<p>Defines the concentration to normalize to.</p>
Mix count	<p>Defines the number of times to mix.</p>
Use secondary target?	<p>Instructs the software to prepare a copy of the normalized samples in a second target plate.</p>
First well	<p>Defines the first well of the secondary target plate, into which the first normalized sample will be pipetted.</p>
Secondary volume	<p>Specifies the volume of normalized samples to be prepared in the secondary target plate.</p>
Allow contamination	<p>Specifies that the tip used to pipet diluent will also be used to pipet source sample. The tip will collect diluent, then sample, and will then eject the liquid into the target well.</p>

Auto adjust small volumes to enable robot to move liquid

Instructs the instrument to round up sample volumes that are less than the minimum volume that can be pipetted (i.e. 1 μ l), to the minimum volume (i.e. 1 μ l). In cases where the operation requires less than the pipettable volume of diluent, no diluent is transferred, only sample is moved. In all such cases, the final volume is preserved, but the desired final concentration is not achieved.

6. Select the diluent and the sample bank which will be used for the sample normalization from the drop-down menus.
7. Click on the  button to select the target reaction plate. The "Plate/well Selector" window will appear.
8. Left-click on a reaction plate to select it. The "Sample Normalization" dialog box will reappear.
Note: If there is only one "Reaction" plate, this plate will be selected by default. To return to the "Sample Normalization" dialog box, left-click on the selected plate.
9. Define the "First well".
10. Define the "Final volume", the "Desired Concentration", and the "Mix count".
11. Define the remaining options in the "Sample Normalization" dialog box as required.
12. Click on the "OK" button to return to the main software workspace. The sample normalization will be added to the "Reaction List".

Add remove waste (pool bank members...)

This function enables liquids from multiple sources to be moved into a waste well (i.e., enabling pooling).

1. Left-click on a "Reaction" plate.
2. The "Reaction" right-hand pane will appear.
3. Click on the "Special" button.

4. Select "Add remove waste (pool bank members...)".
5. The "Remove Waste" dialog box will open.

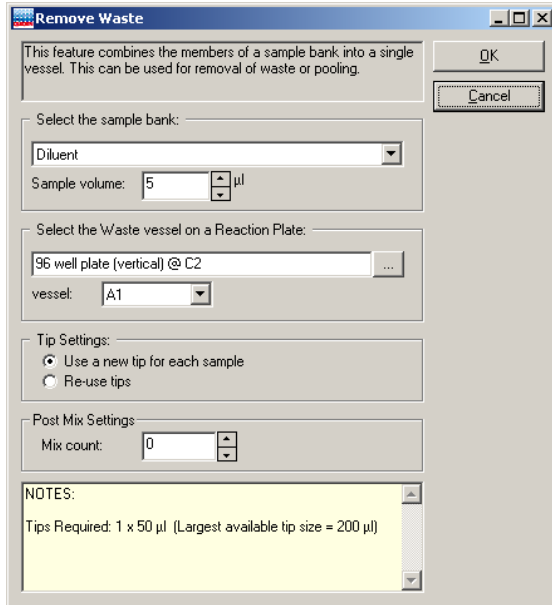

Sample volume Defines the sample volume to be moved to waste.



Opens the "Plate/well Selector" screen, which enables selection of the target reaction plate.

Vessel Defines the vessel in the selected reaction plate to which waste will be moved.

Use a new tip for each sample Instructs the instrument to use a new tip to move each sample.

Re-use tips Instructs the instrument to reuse tips when moving samples to the waste well.

Mix count Defines the number of times to mix the pooled liquids after the final member of the sample bank is added to the waste well/tub.

6. Select a sample bank to be moved to waste from the drop-down menu.
7. Click on the  button to select the target reaction plate. The "Plate/well Selector" window will appear.
8. Left-click on a reaction plate to select it. The "Remove Waste" dialog box will reappear.
Note: If there is only one "Reaction" plate, this plate will be selected by default. To return to the "Remove Waste" dialog box, left-click on the selected plate.
9. Define the "well/tub".
10. Select "Use a new tip for each sample", or "Re-use tips".
11. Click on the "OK" button to return to the main software window. The remove waste command will be added to the "Reaction List".

Note: With this function, more than one sample will be added to one well. Therefore, a warning is displayed at the start of the run.

5.9.7 Importing and exporting reaction and sample data

Import IDs using a bar code reader

Bar code sample IDs can be imported using bar code readers that can connect to a computer via a USB or keyboard wedge. A keyboard wedge is an input device that is inserted between the keyboard plug and the computer keyboard socket. For the best results, the bar code reader system should be able to simulate user tabs or carriage returns appended to the bar code. These simulated tabs or carriage returns automatically move the data input point (cursor) on the data table to the next input cell each time a bar code is read.

1. Left-click on a “Sample” or “Reaction” plate to view the “Sample” or “Reaction” right-hand pane.
2. Click on the  icon. The “Barcode Entry” dialog box will open.

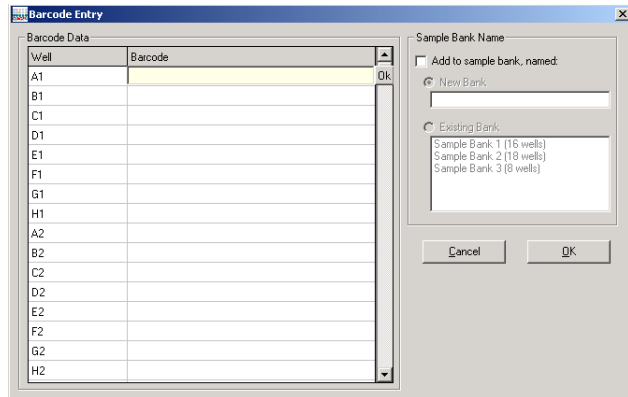



3. Scan the sample or reaction IDs. IDs will automatically be added to the “Barcode Entry” table.
4. To add samples or reactions directly to a sample bank, select “Add to sample bank, named” in the “Sample Bank Name” panel.
5. Select either “New Bank” or “Existing Bank”. If “New Bank” is selected, enter a sample bank name. If “Existing Bank is selected”, left-click on a sample bank to select it.
6. Click on the “OK” button to return to the main software window.

Importing sample and reaction data from a file

All sample and reaction data can be imported and exported from a variety of spreadsheets and text-based files. To import data from Excel files, save the spreadsheet as a CSV (Comma Delimited) file type.

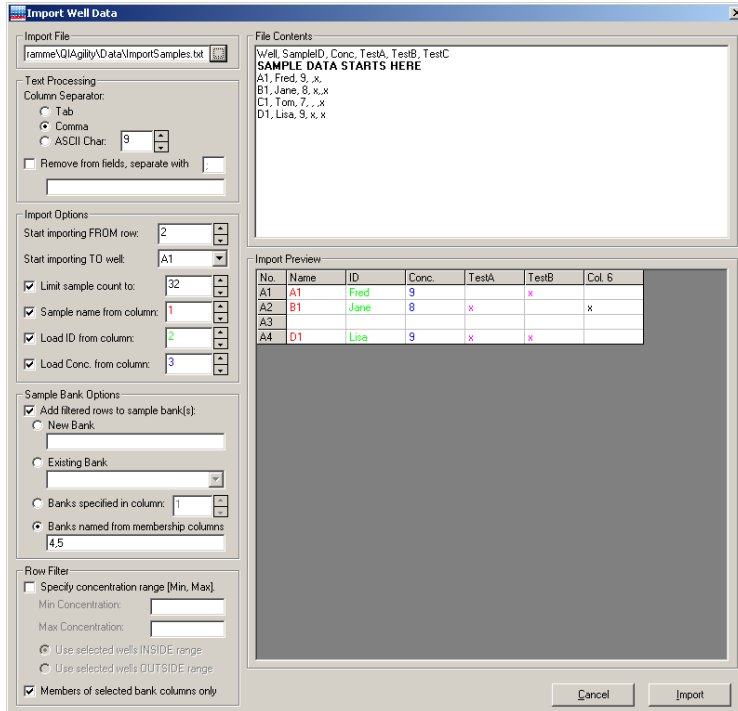
1. Left-click on a “Sample” or “Reaction” plate to view the right-hand pane.
2. Click on the “Import” button. The “Import Well Data” dialog box will appear.



3. Click on the  button. Select the file type to import (i.e., *.csv, *.txt, or *.*), select the file, and then click on the “Open” button.
4. Select the “Column Separator”. “Comma” is the default when selecting a CSV File. Other separators (e.g., tab) can be used. If needed, the ASCII code for any character can be specified, making the import function universal.

Tab The ‘Tab’ character will be used as a separator.

Comma The ‘Comma’ character will be used as a separator.

ASCII Char The specified ASCII value (e.g., 9 (Tab), 44 (Comma), 32 (Space), 58 (Colon)) will be used as a column separator.

5. Some text-based spreadsheets contain strings of \$, ", or # symbols. If these are not required as part of the sample names, select "Remove from fields, separate with". Enter the symbol to be removed. Multiple character sequences can be removed by separating them with ",".
6. In the "Import Options" panel, select the starting import row and well in the "Start importing FROM row" and "Start importing TO well" fields.

Start importing FROM row Defines the first row in the file from which the data will be imported.

Start importing TO well Defines the first well in the "Sample" or "Reaction" plate to which the data will be imported.

7. Select the remaining options in the "Import Options" panel as desired, and select the column from which this information will be imported.

Note: The software will automatically limit the number of rows imported to prevent overrunning the end of the import file and to prevent exceeding the available wells on the plate.

Limit sample count to Defines the maximum number of rows of data that can be imported from the file.

Sample name from column Instructs the software to import the sample name from a specific column in the file.

Load ID from column Instructs the software to import an ID from a specific column in the file.

Load Conc. from column Instructs the software to import a concentration value from a specific column in the file.

8. The "Sample Bank Options" panel of the form describes how data is to be imported to one or more sample

banks in the run. To activate these options, select “Add filtered rows to sample bank(s)”. Only one option may be activated at a time. The options are:

New Bank	Defines the name of a new sample bank. During the import, the new sample bank is created and the wells to which data are imported are used to populate the new sample bank.
Existing Bank	Presents a drop-down list of existing sample banks already configured in the target plate or segment of the run. During the import, the wells to which data are imported are added to the selected sample bank. Existing members of the sample bank prior to the import are retained unchanged.
Bank specified in column	Defines a column that indicates for each row the name of a sample bank containing the well. At most one sample name per well (row) is permitted (and a blank name indicates the well is not a member of any bank). During the import, the software ensures that for the data set imported each sample bank name in the column is created or updated to include the corresponding member well.

Banks named from membership columns

Defines a list of column indices where each referenced column represents the name and contents of a sample bank. For each such column, the name of the sample bank is in the first (header) row of the file and any non-blank value in subsequent rows of the column represents membership of the well in the sample bank.

During the import, the software ensures that for each column in the list the corresponding sample bank is created or updated to include the member wells of that column in the data set imported.

See Sections 5.8.1 and 5.9.5 for more information about how to manage sample banks.

9. The "Row Filter" function allows the user to filter the imported data, limiting the selection of rows prior to import. During import, only filtered rows presented in the "Import Preview" pane are included in the imported data set. Two filters may be used. When used together, only rows matching both filtering criteria are included in the selected data set.

The first filter is based on a concentration range. If desired, select the "Specify concentration range [Min, Max]" function and then define the options as required. Filtering is based on the concentration values present in the column selected in the "Load Conc. from column" configuration option. When active, the "Import Preview" pane shows only those rows where the concentration filter criteria are met.

Min Concentration

Defines the minimum concentration of the concentration range.

Max Concentration

Defines the maximum concentration of the concentration range.

Use selected wells INSIDE range	Instructs the software to select rows where the concentration value is within the defined concentration range.
Use selected wells OUTSIDE range	Instructs the software to select rows where the concentration value is outside the defined concentration range.

The second filter is based on membership in at least one sample bank selected from the file. This function, "Members of selected bank columns only", is available when "Bank from column" or "Banks named from membership columns" is selected. When the filter is activated, the "Import Preview" pane shows only rows with a non-blank value in the selected "Bank from column" or with a non-blank value in any one of the columns listed at "Banks named from membership columns".

10. The "Import Preview" panel displays the samples to be imported. Click the "Import" button to import the data. The imported data will be displayed in the right-hand pane.

Note: No data is imported from a row in which all fields are empty.

Note: Existing data will be overwritten by any imported data that is located in the same well.

Note: Multiple sample banks **simultaneously** imported using the "Banks named from membership columns" function. Alternate strategies allow multiple sample banks to be **successively** populated from the same import file. For example this can be done using the "Bank from column" function, where several columns, one per sample bank, are present in the file and each row includes the bank name in the corresponding column to indicate its membership in that bank. Set the "Bank from column" and activate the "Members of selected bank columns only" filter. Click on the "Import" button. Repeat for each sample bank column in the file. It can also be done using the concentration filter function. Arrange the import file so that it has a column

representing each sample bank. Populate the rows in each column with a concentration value (e.g., 0) to indicate membership of that sample in that bank. Set the "Row Filter" to include rows with concentrations in the range (0, 0). Set the "Load Conc. from column" and choose the sample bank name as a "New Bank" or "Existing Bank". Click on the "Import" button. Repeat for each sample bank column in the file.

Exporting sample and reaction data

Sample and reaction data, which is listed in the "Sample" and "Reaction" right-hand pane, can be exported in a number of formats. This can be used to transfer data to the Rotor-Gene Q, or other data storage systems (e.g., LIMS environments).

To export sample or reaction data:

1. Left-click on a "Sample" or "Reaction" plate to view the right-hand pane.
2. Click on the "Export" button. The "Export Samples" or "Export Reaction Info" dialog box will appear.

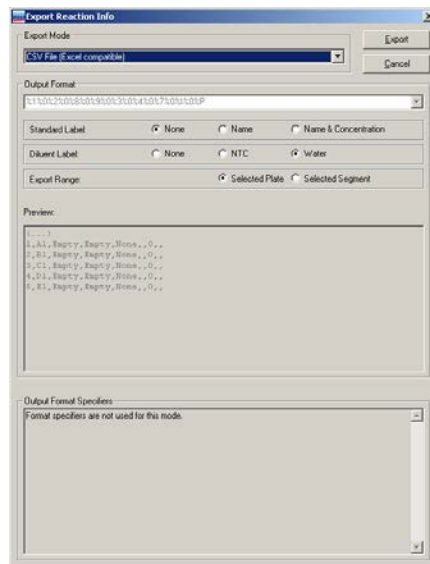

3. Select an "Export Mode" from the drop-down menu.

CSV File (Excel compatible)	A *.csv text file with comma separators between columns. The data is fixed and contains the number, location, sample name, reagent name, sample type, concentration, and target volume.
Rotorgene v4.4	A *.sam sample file which is compatible with the Rotor-Gene 2000/3000 software version 4.6–5.x. The data is fixed and contains location, sample name, and sample type.
Rotorgene v4.6 or later	A *.smp sample file which is compatible with the Rotor-Gene Q software version 4.6 or later. The data contains the sample concentration and a user selectable sample identifier which can be either sample name or sample ID.
Custom, comma separated	A *.csv text file with comma separators between columns. The data can be user-defined.
Custom, tab separated	A *.txt file with tab separation between columns. The data can be user-defined.
Export directly into Excel 97 or later	Creates an .xls spreadsheet file and if Excel is installed on the computer, automatically launches Excel with the imported data. The data can be user-defined.
Tube Map CSV file	A *.csv file with format fixed as “well-location, plate identifier, sample identifier” (using the substitution pattern %2%0%P%0%I, as described in “Data fields” in this section). This describes the mapping of a tube/well location (plate and well label) to its contents (sample identification).

Rotor-Gene Q v1.x, 6000 v1.x & 3000 v6.x	A *.smp sample file which is compatible with the Rotor-Gene Q, Rotor-Gene 6000, and late revisions of the Rotor-Gene 3000 software. The data for each reaction contains a user selectable sample identifier and a user selectable concentration. Data can be grouped into "pages" according to the master mix and/or reaction identification. See Appendix E.
ABI 7000/ 7500 SDS absolute quantification	A 'Setup Table Format' file which can be used with the ABI 7000/7500 SDS software v1.2.3 for absolute quantification. Master mixes must be named in the QIAgility software according to special conventions which allow the identification of Detector, Reporter, Quencher entities required by the ABI SDS software. See Appendix E.
ABI 7000/ 7500 SDS allelic discrimination	A 'Setup Table Format' file which can be used with the ABI 7000/7500 SDS software v1.2.3 for allelic discrimination. Master mixes must be named in the QIAgility software according to special conventions which allow the identification of Marker entities required by the ABI SDS software. See Appendix E.
QIAxcel BioCal 3.2 (8x12 well grid)	A *.csv 'Sample Info Text' file which can be imported into the QIAxcel® software. The data is organized in a 8 x 12 grid that contains a user-selectable identifier for each well of the 96-well plate.
QIAxcel ScreenGel (XML)	A *.xml file which can be imported to the QIAxcel ScreenGel software. This format requires a 96 well plate.

Generic XML A *.xml file following the schema defined in
...\\Integration\\xsd\\GenericXMLFormat.xsd
It is also possible to select a XSL transformation file that will transform the generic XML format into another format that is required for your lab system. See Appendix G.

4. Choose an output format. The output formats available depend on the "Export Mode" that was selected.

Sample Label Determines how the sample is to be named when the data is imported into the Rotor-Gene software.

Concentration Option Determines the concentration value to be associated with the reaction for import into the Rotor-Gene software.

Page Option Determines how the reaction data is to be grouped for analysis purposes after import into the Rotor-Gene software.

Empty Label Determines how unpopulated reaction wells are named during export to the QIAxcel Sample Import Text file format.

"Sample Label"

Full ID Comprises the identifier of the reaction well (Reaction ID) and all identifiers of contained samples (Sample ID).

Sample ID A list of sample identifiers present in the reaction well.

Reaction ID The user-assigned label associated with the reaction well.

Sample Name A list of sample names present in the reaction well.

“Concentration Option”

Sample/Source	Uses the initial concentration value. This is associated with the source sample or standard well.
Final Reaction	Uses the final concentration value of the sample or standard after dilution with other ingredients. This is associated with the reaction well.

“Page Option”

Master Mix	Reactions are segregated according to the master mix present in the well, with one page created for (and named after) each master mix.
Reaction ID	Reactions are segregated according to the reaction ID (user-assigned label) associated with the well, with 1 page created for (and named after) each reaction ID.
Both	Reactions are segregated according to the combination of master mix and reaction ID, with 1 page created for (and named after) each unique grouping of master mix name and reaction ID.
None	All reactions are placed into a single page called ‘Page 1’.

“Empty Label”

None	No identification is used (blank).
Label	The well label is used as the identifier.
Label Number	The index of the well in the pipetting sequence is used as the identifier.

Well Number The index of the well in the (horizontal) sequenced grid export is used as the identifier.

“Export range”

Selected Plate All reactions on the selected reaction plate will be exported, even if the plate has more than one segment.

Selected Segment Only the reactions in the selected segment of the reaction plate will be exported.

“Well numbers” (This option is only available if “Export Range” is set to “Selected Segment”.)

Relative to Segment The well numbers start with 1 at the beginning of the selected segment and proceed in the selected display order (label or pipet) within the segment.

Relative to Plate The well numbering starts at the beginning of the plate and proceeds in the selected display order (label or pipet) over the whole plate.

5. Click on the “Export” button.
6. Enter a file name and select the location to which the data will be exported.
7. Click on the “Save” button to continue.

Data fields

Data fields, which are available for export, and their export string designators, are as follows.

Substitution symbol	Sample export	Reaction export
%0	Separator (comma,	Separator (comma,

	tab)	tab)
%1	Well number in selected display order (label or pipetting sequence, e.g., 10)	Destination well number in selected display order (label or pipetting sequence, e.g., 10)
%2	Well location (address label, e.g., G3)	Destination well location (address label, e.g., G3)
%3	Sample type (none, unknown, standard)	Sample type (none, unknown, standard)
%4	Concentration (if known)	Source concentration (if known)
%5	Sample name	Final contents, including full names and volumes
%7		Target volume

Substitution symbol	Sample export	Reaction export
%8		Name (sample), including volume
%9		Name (reagents), including volume
%A		Final contents including full names, excluding volumes
%S		Name (sample), excluding volume
%R		Name (reagents), excluding volume
%V		Sample volume

%F		Final concentration (if known)
%P	Plate ID	Destination plate ID
%p		Source plate ID
%I	Sample ID	Total ID, including tube/reaction ID and constituent IDs of contained samples
%C		Constituent IDs of contained samples
%T		Tube/reaction ID
%W		Source well location (address label, e.g., B4)
%B		Sample type (ABI) Possible values: "UNKWN", "NTC", "Standard"

In the export modes where the data can be freely defined, the user must specify the data content by writing an export string. During export these designators are substituted with actual corresponding data. For example, to generate a *.csv file from a sample plate which contains the sample number, the sample location and the sample ID, a valid format string would be:

%1 %0 %2 %0 %I

The %0 between the individual data fields indicates that a separator is to be inserted. A separator will result in a comma in the case of a *.csv file. In an Excel spreadsheet, a column break would be inserted.

5.9.8 Progress report

When a run is in progress, the status of the run is summarized in the right-hand pane.

Progress

Start time: 1:03 PM
 Current time: 1:04 PM
 Estimated time of completion: 1:44 PM

40 minutes remaining

Tasks

Task	Progress
Adding 903.5 µl Diluent to MM RAN-BP2	COMPLETE
Adding 130 µl PreMaster Mix to MM RAN-BP2	COMPLETE
Adding 26 µl dNTP's to MM RAN-BP2	COMPLETE
Adding 6.5 µl Enzyme to MM RAN-BP2	COMPLETE
Adding 52 µl Primer for RAN-BP2 to MM RAN-BP2	COMPLETE
Adding 52 µl Primer rev RAN-BP2 to MM RAN-BP2	COMPLETE
Adding 903.5 µl Diluent to MM GAPDH	COMPLETE
Adding 130 µl PreMaster Mix to MM GAPDH	COMPLETE
Adding 26 µl dNTP's to MM GAPDH	*ACTIVE*
Adding 6.5 µl Enzyme to MM GAPDH	
Adding 52 µl Primer for GAPDH to MM GAPDH	
Adding 52 µl Primer rev GAPDH to MM GAPDH	
Adding 903.5 µl Diluent to MM TAF II 100	
Adding 130 µl PreMaster Mix to MM TAF II 100	
Adding 26 µl dNTP's to MM TAF II 100	
Adding 6.5 µl Enzyme to MM TAF II 100	
Adding 52 µl Primer for TAF II 100 to MM TAF II 100	
Adding 52 µl Primer rev TAF II 100 to MM TAF II 100	
Adding 903.5 µl Diluent to MM Alpha Catenin	
Adding 130 µl PreMaster Mix to MM Alpha Catenin	
Adding 26 µl dNTP's to MM Alpha Catenin	

5.10 Programming run files

5.10.1 PCR Setup Wizard

The “PCR Setup Wizard” enables typical PCR reactions, with samples, standards, and master mixes, to be set up. The wizard allows the user to set up reagents, and then use these to prepare master mixes. The wizard can also be used to set up master mixes without setting up reactions.

This section outlines the “PCR Setup Wizard” screens that will guide the user through the setup. Instructions are displayed on each screen.

Note: Depending on the type of run being set up, only some of the screens will be used.

To set up a PCR reaction, using the “PCR Setup Wizard”:

1. Select “Wizard/PCR Setup Wizard”, or select “PCR Setup Wizard” from the splash screen that appears when the software is started.
2. The “QIAgility Setup Wizard” will appear.

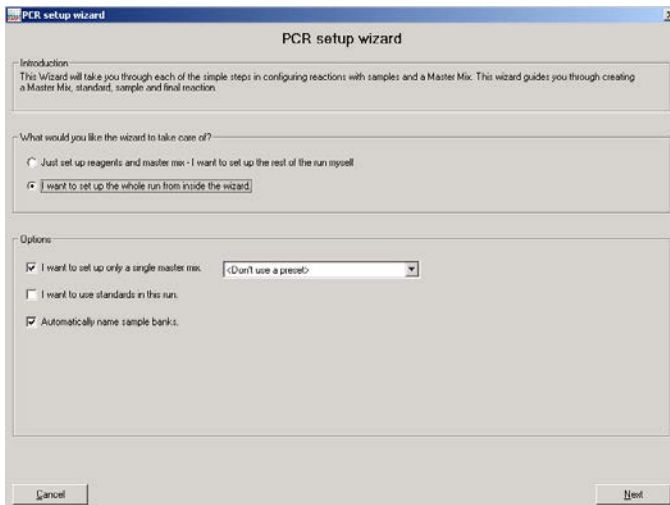

3. Select the desired options and then click on the “Next” button.

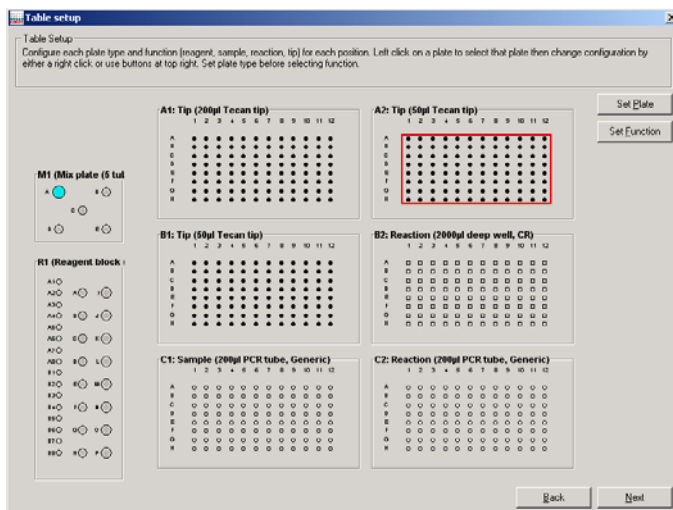

Set Plate Opens the “Plate Configuration” dialog box, which provides options to change the plate type. See Section 5.7.1 for more details about how to change the plate type using the “Plate Configuration” dialog box.

Set Function Opens a submenu which provides options to change the plate function. See Section 5.7.1 for more details about the available plate functions.

4. Left-click on a plate to select it. Click on the “Set Plate” button.
5. The “Plate Configuration” dialog box will open. Change the plate type as outlined in Section 5.7.1.
6. Repeat steps 4–5 for all plates on the worktable.
7. Left-click on a plate to select it. Click on the “Set Function” button. A submenu will appear. To update the plate function, select “Sample”, “Reaction”, “Reagent”, “Standard”, or “Mix”.
8. Repeat step 7 for all plates on the worktable.
9. Click on the “Next” button to continue.

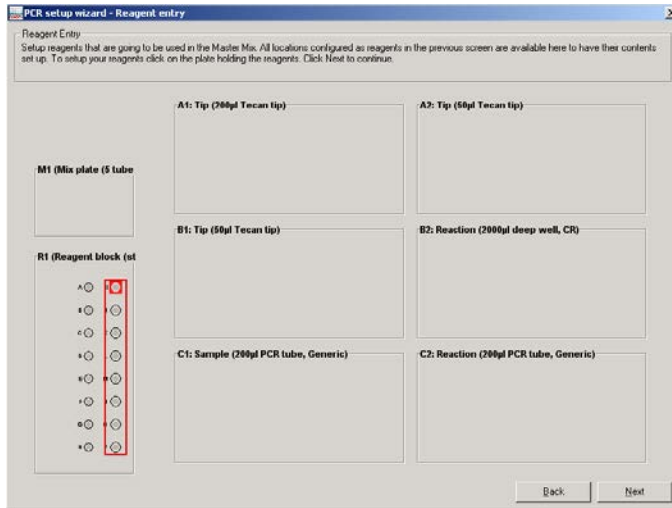

10. Left-click on a plate which has “Reagent” function. The following dialog box will appear.

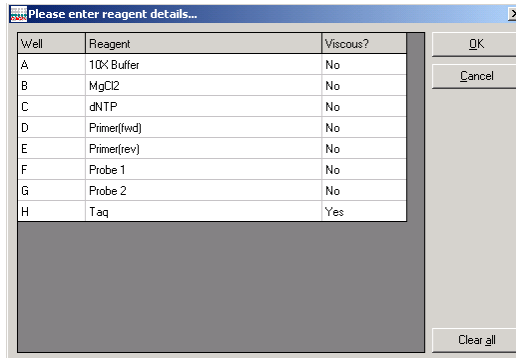

Clear all Clears all information in the “Reagent” column and updates all cells in the “Viscous?” column to “No”.

11. To change the reagent name, left-click on a cell in the “Reagent” column, and then enter a new name. To change a reagent from viscous to non-viscous, left-click on a cell in the “Viscous?” column, check the box, and then click on the “OK” tab. Repeat this procedure to change a reagent from non-viscous to viscous.

12. Click on the “OK” button to continue.

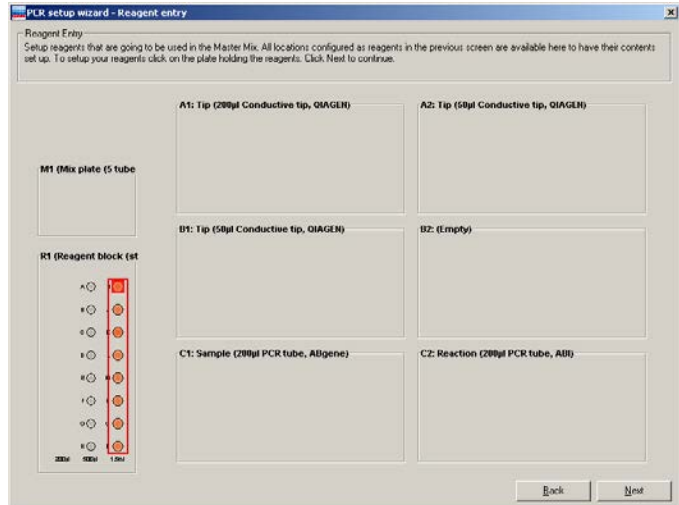

Repeat this step until all reagent segments you want to use are defined.

13. Click “Next” to continue.

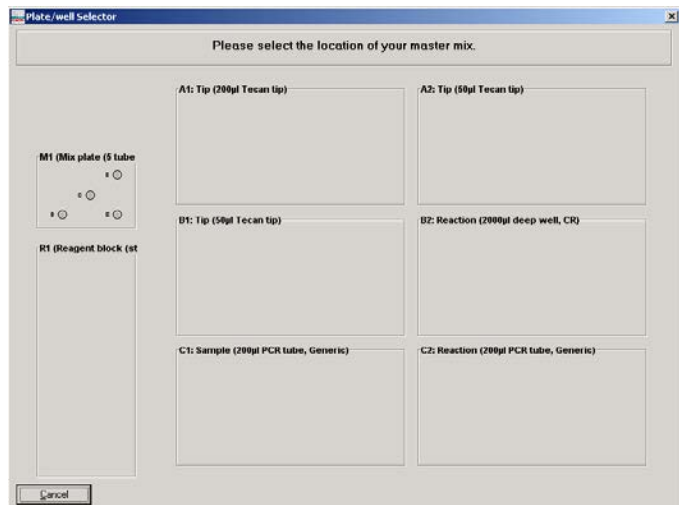

14. Left-click on a well in the Master Mix Block to select the location of the master mix. The “Master Mix Component Selection” dialog box will appear.

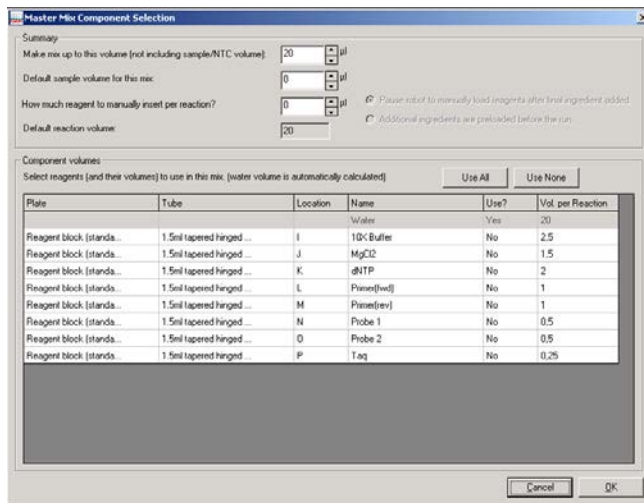

15. Configure the components of the master mix, as outlined in Section 5.9.4.
16. Click on the “OK” button to continue.
17. The “Standards Editor” screen will appear. (Steps 17 to 21 will only appear if you selected “I want to use standards in this run” on the first page of the wizard.)

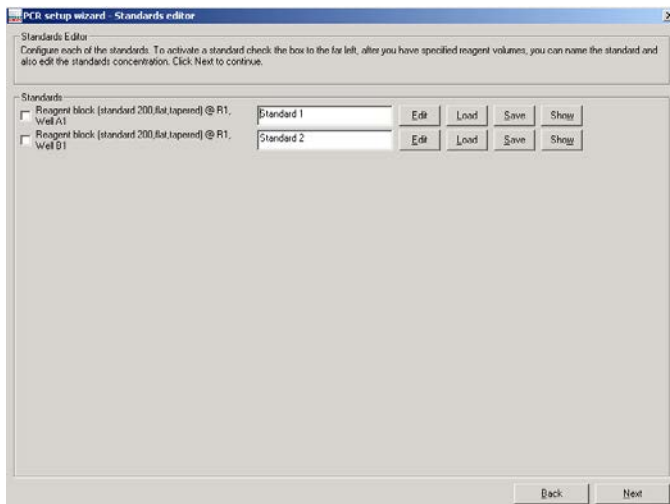

Edit	Opens the “Edit Standard” dialog box, which enables a standard to be configured.
Load	Enables a predefined standard dilution series configuration to be loaded from a file.
Save	Enables the current standard dilution series configuration to be saved in a file.
Show	Illustrates the location of the standard dilution series on the worktable.

18. Select a standard from the list. The following dialog box will appear.

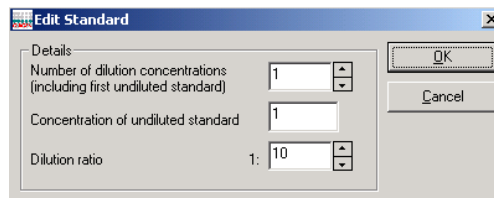

Number of dilution concentrations	Defines the total number of wells in the dilution series, including the initial undiluted (stock) well of the standard.
Concentration of undiluted standard	Defines the concentration of the starting undiluted (stock) well of the standard dilution series.
Dilution ratio	Defines the dilution ratio for successive wells in the standard dilution series. Concentrations of successive wells in the series are determined by multiplying the concentration of the preceding well in the series by the dilution ratio.

19. Define the “Number of dilution concentrations”, the “Concentration of undiluted standard”, and the “Dilution ratio”.

20. Click on the “OK” button to continue.
21. Repeat steps 18–20 for any remaining standards.
22. Click on the “Next” button to continue.
23. The “Sample Editor” screen will appear.

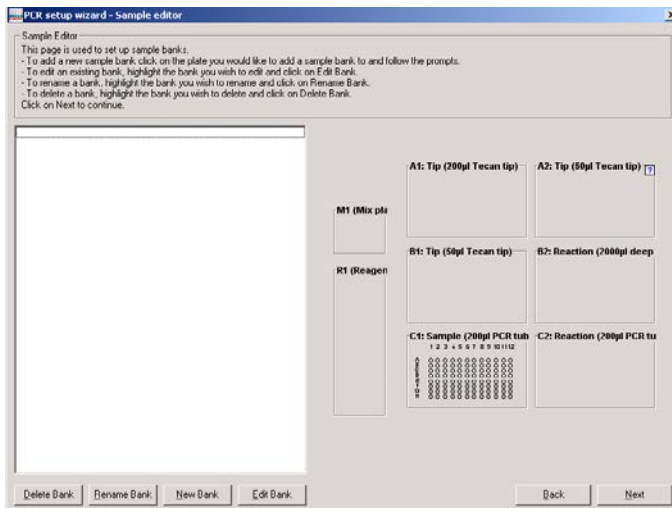

- | | |
|-------------|--|
| Delete Bank | Deletes selected sample bank. |
| Rename Bank | Opens a dialog box from where the sample bank name can be changed. Click on the “OK” button to continue. |
| New Bank | Displays the “Update Sample Bank” dialog box, which enables a new sample bank to be created. See Section 5.8.1. |
| Edit Bank | Displays the “Update Sample Bank” dialog box, which enables an existing sample bank to be modified. See Section 5.8.1. |

24. Existing sample banks will be listed on the left side of the dialog box. Use the buttons beneath the list to manage the sample bank list. Alternatively, left-click on a plate with “Sample” or “Reaction” function. The

“Update Sample Bank” dialog box will appear. Create sample banks as outlined in Section 5.8.1.

25. Click on the “Next” button to continue.

26. The “Reaction Editor” screen will appear.

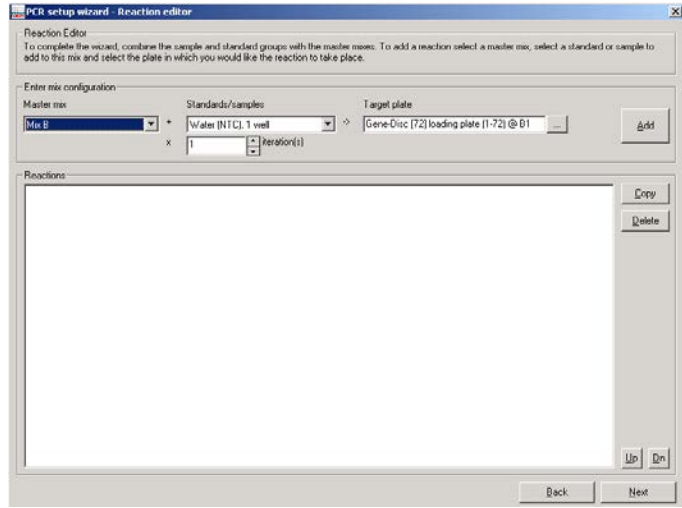

Master mix Defines the master mix that will be used in a reaction.

Standards/- samples Defines the standard or sample that will be used in a reaction.

iteration(s) Defines the number of reaction replicates that will be performed.

Target plate Defines the target plate that the reaction will be pipetted into.



Opens the “Plate/well Selector” screen, which enables selection of the target reaction plate.

Add Adds a reaction to the “Reactions” list.

Copy	Enables a selected reaction to be copied within the "Reactions" list. Options to "Copy in-place?", "Copy to end of list?", or "Cancel" will appear.
Delete	Deletes a selected reaction in the "Reactions" list.
Up	Moves a selected reaction in the "Reactions" list 1 position up the list.
Dn	Moves a selected reaction in the "Reactions" list 1 position down the list.

27. Select a master mix from the drop-down menu.
28. Select a standard or sample from the second drop-down menu and define the number of replicates in the field below.
29. Click on the  button to define the "Target plate".
30. Click on the "Add" button. The reaction will now be added to the "Reactions" list.
31. Repeat steps 26–29 for all required reactions.
32. Click on the "Next" button.
33. The following message will appear.

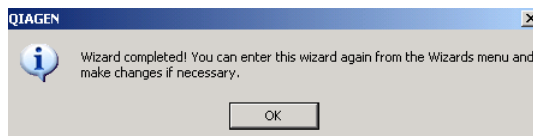

34. Click on the "OK" button to return to the main software window.

5.10.2 Optimisation Wizard

The "Optimisation Wizard" enables matrix combinations of reactions, based on different concentrations of reagents, to be set up.

For example, to optimize a probe and primer (forward and reverse combined), a reaction could be set up with 3

different concentrations of the probe and with 3 different concentrations of primer (i.e., a total of 9 reactions). Several optimizations are possible using the "Optimisation Wizard".

Note: The user must provide all required concentrations of all the variables that are to be optimized.

This section outlines the "Optimisation Wizard" screens that will guide the user through the setup. Instructions are displayed on each screen.

Note: The "Optimisation Wizard" only provides steps to set up an optimized matrix, it does not provide steps for preparation of a master mix.

To set up a PCR reaction using the "Optimisation Wizard":

1. Select "Wizard/Optimisation Wizard", or select "Optimisation Wizard" from the splash screen that appears when the software is started.
2. The "Optimisation Wizard" will appear.

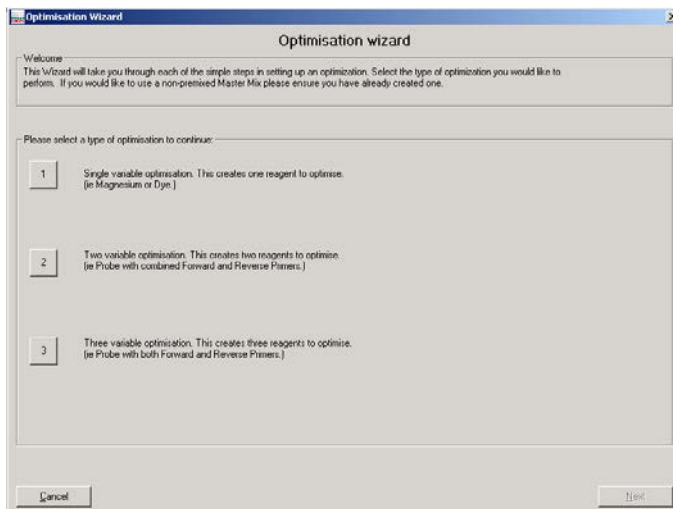

3. Select option "1", "2", or "3". These options define the number of variables to be optimized.
4. Click on the "Next" button to continue.

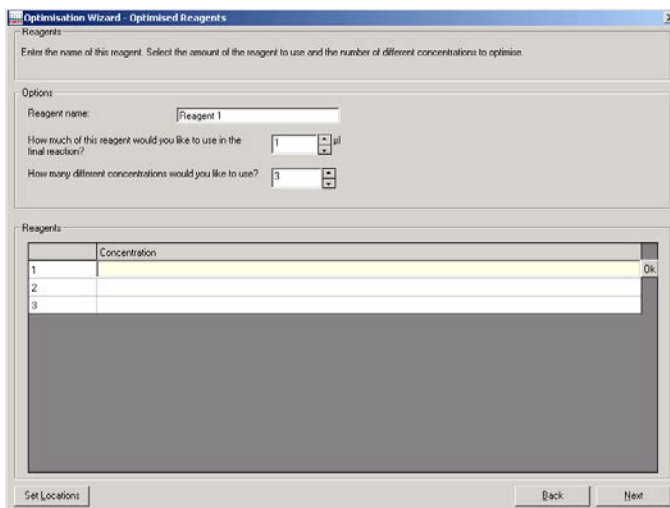

- Reagent name Defines the name of the reagent.
- How much of this reagent would you like to use in the final reaction? Defines the volume of reagent to be used in the reaction.
- How many different concentrations would you like to use? Defines the number of different concentrations of reagent to be optimized.
- Set Locations Opens the "Reagent selector" window, which enables selection of the location of reagents on the software worktable.
5. Define the reagent name.
 6. Define the volume of reagent to use in the final reaction.
 7. Define the number of different concentrations to use. The number of rows in the "Reagents" table will be adjusted accordingly.

8. Enter the concentrations directly into the “Reagents” table.
9. Click on the “Next” button.
10. The “Reagent selector” window will open. The reagents are listed in the “Reagents” panel in white boxes.

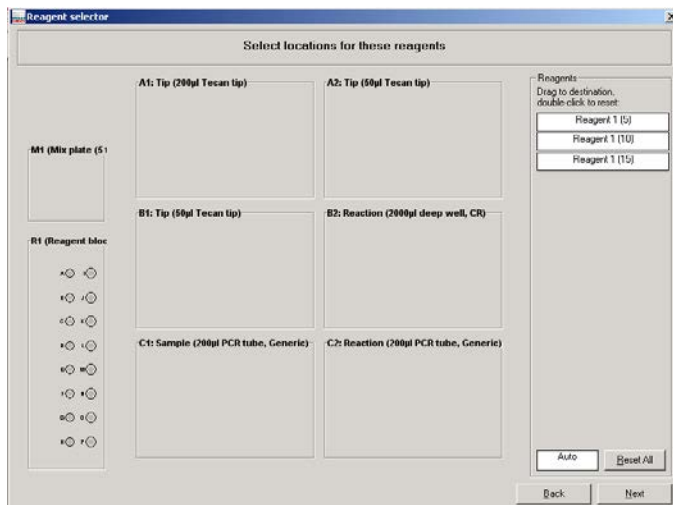

11. Each reagent must be assigned a location, otherwise the reagent import will be canceled. To do this, left-click on a reagent and drag it to the desired well on a reagent plate. Do this for all the reagents. If the reagent locations do not matter, click and drag the “Auto” white box to the desired reagent segment. Reagents will automatically be assigned to a location. Selected wells will be highlighted red.
Note: Some reagent locations may already be in use by previously defined reagents. If the name of the reagent used in the saved master mix setup is identical to reagents already set up, these will automatically be allocated to those positions.
12. To reset the location of any reagent, double-click on a reagent in the list, then left-click and drag again. Alternatively, click on the “Reset All” button to clear all reagent locations, other than those that were defined upon entering the screen.

13. Click on the “Next” button.
14. If only one reagent will be optimized (i.e., if option “1” was selected in step 3), proceed to step 15. If more than one reagent will be optimized (i.e., option “2” or “3” was selected in step 3), repeat steps 7–13, and then proceed to step 15.
15. The “Optimisation Wizard — Replicates” dialog box will appear.

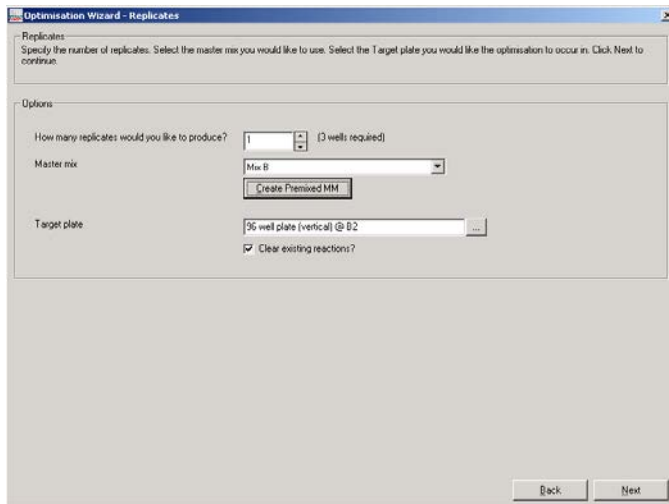

How many replicates would you like to produce?

Defines the number of replicates for each reaction.

Master mix

Defines the master mix to be used.

Create Premixed MM

Opens the “Plate/well Selector” window, which enables a premixed master mix to be set up.

Target plate

Defines the target plate that the reactions will be pipetted into.



Opens the “Plate/well Selector” screen, which enables selection of the target reaction plate.

Clear existing reactions?

When selected, the wizard deletes all existing reactions in the run before generating the optimization reactions. When this option is not selected, the wizard appends the optimization reactions to the existing reaction list.

16. Define the number of replicates for each reaction.
17. Define the master mix to be used in the reaction.
18. Click on the “Create Premixed MM” button. The “Plate/well Selector” window will appear.

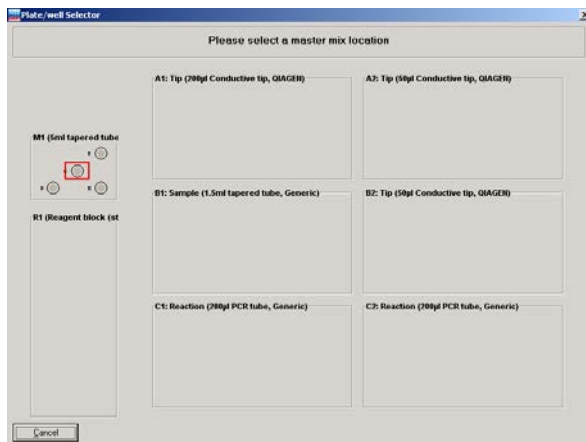

19. Left-click on a well in the Master Mix Block to select the location of the master mix.
20. The following message box will appear.

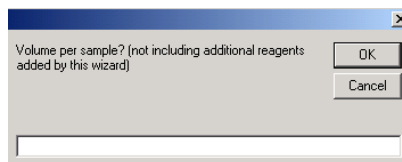

21. Enter the volume of master mix to be used per reaction.

22. Click on the “OK” button.



23. Click on the “OK” button to return to the main software window.

5.10.3 Using “Empty Project”

1. Select the  icon from the toolbar. The following splash screen will appear. This splash screen will also appear when starting the software, and can also be accessed by selecting “File/New”.

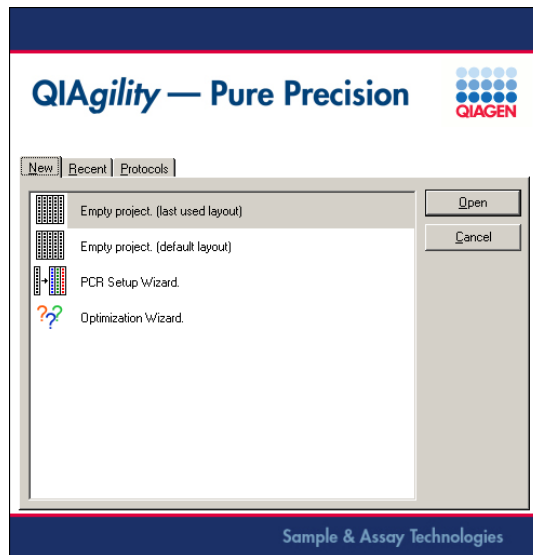

2. Select either “Empty Project (last used layout)” to use the layout from the most recent run, or “Empty Project (default layout)” to use a conventional layout as presented immediately after initial installation. Then click on the “Open” button.
3. Select the correct plate type in the software for each position on the worktable. The plate types selected in the software must match the actual worktable setup.

See Section 5.7.1 for details about how to change plate types.

4. Select the correct plate function for each plate on the worktable (i.e. "Diluent", "Reaction", "Reagent", "Standard", "Mix" or "Tip"). See Section 5.7.1 for details of how to change plate function.
Note: Ensure that only plates that have been position and height calibrated are used.
5. Set the tip availability for every plate that has "Tip" function. See Section 5.7.2 for details about setting tip availability.
6. Configure the samples, diluent, standards, reagents and master mix. See Section 5.9.
7. Set up the reaction list. See Section 5.9.6 for details about how to do this. In addition, see Section 5.10.4 for examples of how to set up typical reactions.
8. To save the run file, select "File/Save As". Enter a name for the run file and select a location in which to save it.
9. Click on the "Save" button.

5.10.4 Example reactions

This section outlines the protocols for setting up a number of typical reactions.

Open the "Reaction" right-hand pane, as outlined in Section 5.9.6, and then use one of the following example reactions:

- Master mix with no sample
- Master mix with sample bank
- Sample bank with no master mix
- Sample bank with reagents not used in master mix
- Sample bank with master mix and reagents not used in a master mix
- No template control with master mix
- Alternate samples or standards with no template control
- Empty wells

Master mix with no sample

1. Select “No samples (empty wells)” from the “Samples” panel.
2. Select the master mix.
3. Enter the number of replicates in the “Target wells” panel. The number of replicates will equal the number of wells in the reaction plate.
4. Click on the “OK” button.

Master mix with standard

1. Select the dilution series from the “Samples” panel.
2. Select the master mix.
3. Enter the number of replicates in the “Target wells” panel.
4. Click on the “OK” button.

Master mix with sample bank

1. Select the sample bank from the “Samples” panel.
2. Select the master mix.
3. Enter the number of replicates in the “Target wells” panel.
4. Click on the “OK” button.

Sample bank with no master mix

1. Select the sample bank from the “Samples” panel.
2. Set the sample volume in the “Volume” panel.
3. Enter the number of replicates in the “Target wells” panel.
4. Click on the “OK” button.

Sample bank with reagents not used in master mix

1. Select the sample bank from the “Samples” panel.
2. Select the reagents from the “Unmixed reagents” panel.

3. Enter the number of replicates in the "Target wells" panel.
4. Click on the "OK" button.

Sample bank with master mix and reagents not used in a master mix

1. Select the sample bank from the "Samples" panel.
2. Select the master mix.
3. Select the reagents from the "Unmixed reagents" panel.
4. Enter the number of replicates in the "Target wells panel".
5. Click on the "OK" button.

No template control with master mix

1. Select "Diluent" from the "Samples" panel.
2. Select the master mix.
3. Enter the number of replicates in the "Target wells panel".
4. Click on the "OK" button.

Alternate samples or standards with no template control

1. Select the sample bank from the "Samples" panel.
2. Select the master mix.
3. Check the "Alternate sample wells with diluent?" box.
4. Click on the "OK" button.

Empty wells

1. Select "No samples (empty wells)" from the "Samples" panel.
2. Enter the number of empty wells in the "Target wells panel".
3. Click on the "OK" button.

5.10.5 Checking the reaction setup

A reaction setup can be checked in 2 ways:

1. Run a simulation of the reaction setup in “Virtual Mode”. See Sections 5.1 and 5.2 for more information about “Virtual Mode” operation.
2. Place the cursor over a source well to check the destination well(s) of the source well. The destination wells will be highlighted. For instance, if the cursor is placed over a master mix well, the wells on the reaction plate that will contain that master mix are highlighted.

5.10.6 Required volumes for reaction setup

The software automatically calculates the volume of standard, diluent, reagents, and master mix required for a reaction setup. To view the volume of liquid required, generate the pre-run report. This report will list the required volumes. See Section 6.7.1 for more information about the pre-run report.

Alternatively, position the cursor above a source well (i.e., diluent, reagent, master mix, or standard). A hover box will appear that reports the volume required. This volume includes an extra volume, to account for the dead volume, that is dependent on the tube type.

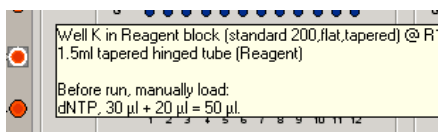

5.11 Selecting the COM port

1. Select “Options/Robot Setup/Select COM port”.
2. The “Configure Serial Interface” dialog box will open.

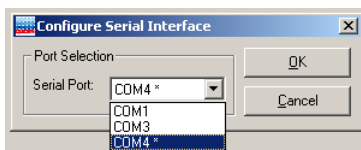

3. Select the desired COM port from the drop-down menu and then click on the "OK" button.

Note: The software lists only eligible COM ports and marks the mostly likely port on which the instrument can be found with an asterisk (*). For correct communication of the laptop (supplied with the QIAgility) with the instrument:

4. The following message will appear.

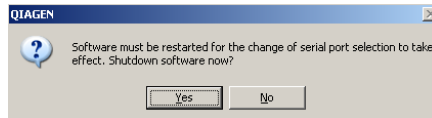

5. Click on the "Yes" button to shut down the software.
6. Restart the software.

5.12 Service register

The service register describes the current status of maintenance alert notification records that are associated with the instrument. The software maintains a schedule of required service activities in the service register.

Maintenance activities that are scheduled for future dates are displayed as green records. When a scheduled maintenance activity is due, the record is displayed in red, and a service alert notification is generated.

If the system has any unacknowledged service alert notifications, the  icon in the toolbar is marked with a red exclamation mark.

Service alert notifications can be acknowledged by an operator, using the "Service Register" dialog box.

To view the "Service Register" dialog box:

1. Select "Options/Robot Setup/Service register".
2. The "Service Register" dialog box will appear.
3. The component that requires a service most urgently will be preselected (i.e. "Pippettor" or "Hepa Filter"). Components that are colored red are due for a service,

and components that are colored green are due for a service at a future date.

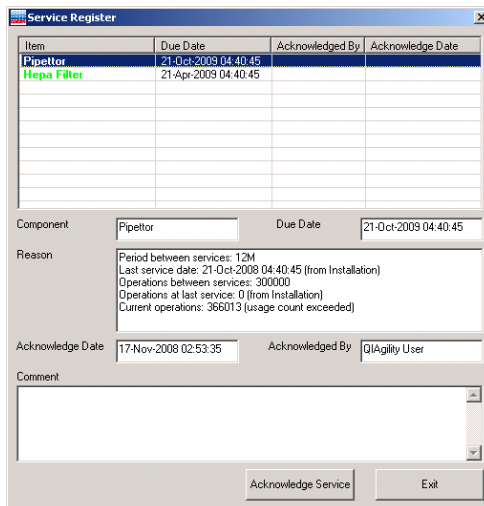

- Component Defines the selected component to be serviced — “Pipettor” or “Hepa Filter”.
- Due Date Defines the date that a service is required.
- Acknowledg- Displays the current date and time.
ment Date
- Acknowledged Displays the current user name.
by
- Comment Allows the user to enter and save comments with the acknowledgment of a service.
- Acknowledge Confirms that the selected service has
Service been completed.
- Exit Closes the “Service Register” dialog box.

To acknowledge a service:

1. Select the component that has been serviced.

2. Enter your user name in the "Acknowledged By" field.
3. If desired, enter further details about the service in the "Comment" field.
4. Click on the "Acknowledge Service" button.
5. A message will appear which summarizes the service acknowledgment.

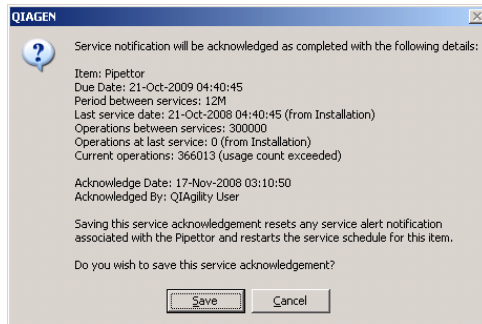

6. Click on the "Save" button to save the service acknowledgment.
7. The service that has been acknowledged will now be colored black in the "Service Register" dialog box. In addition, the component will be colored in green, as a reminder of a future service.

Note: Once a service has been acknowledged and saved, it cannot be edited.

Note: A component can be serviced at anytime — it does not need to be colored red in the "Service Register" dialog box for a service to be performed.

Note: After acknowledgment of a pipettor service, volume calibration must be done before the start of the first run. An error is shown at the start of a run if no volume calibration has been done.

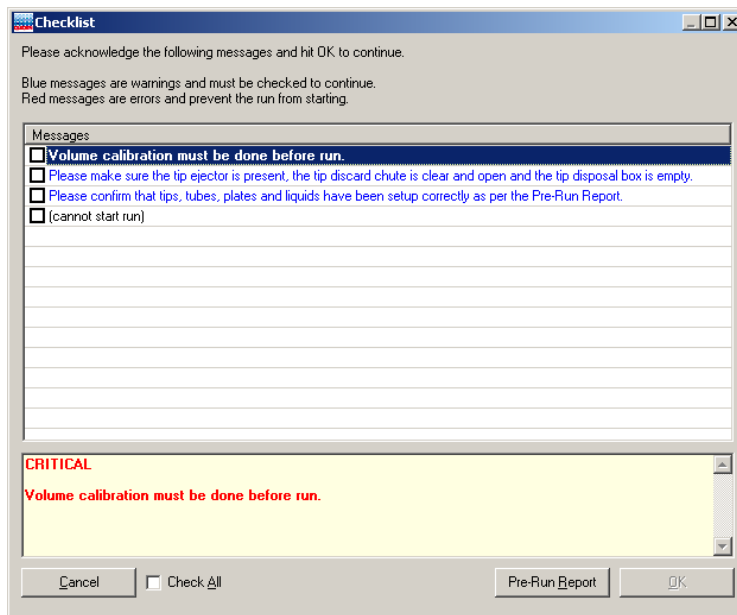

This page intentionally left blank



6 Operating Procedures

This section describes how to operate the QIAgility.

Before proceeding, we recommend that you familiarize yourself with the features of the QIAgility by referring to Sections 3.2 and 3.2.10.

The QIAgility lid must remain closed during operation of the instrument. Only open the lid when the instrument is not operating or when instructed to do so by the software.

Note: Opening the lid during operation of the QIAgility will cause the system to pause. The instrument will complete the current movement, which may take up to 10 seconds.

<p>WARNING/ CAUTION</p> 	<p>Risk of personal injury and material damage [W4] Do not attempt to move the QIAgility during operation.</p>
<p>WARNING</p> 	<p>Moving parts [W12] To avoid contact with moving parts during operation of the QIAgility, the instrument must be operated with the lid closed. If the in-built lid sensor is not functioning correctly, contact QIAGEN Technical Services.</p>

6.1 Starting the software

Note: Before starting the software, ensure that the instrument lid is closed and that the QIAgility is switched on.



1. Double-click on the "QIAgility" icon on the desktop.
2. If the instrument is connected to the computer, the software will proceed automatically to "Normal Mode" operation. If the instrument is not connected to the

computer, or if the instrument is switched off, the software will run in “Virtual Mode”. See Section 5.2 for more details about “Virtual Mode” operation.



3. The welcome dialog will open.

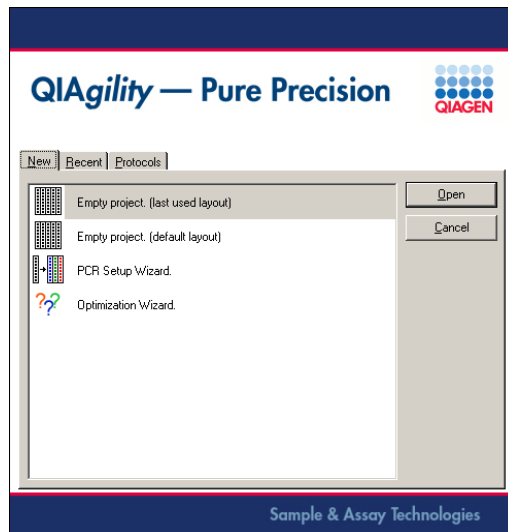

To create a new run file, select “Empty project (last used layout)”, “Empty project (default layout)”, “PCR Setup Wizard” or “Optimisation Wizard”, and then click on the “Open” button to continue. See Sections 5.10.1, 5.10.2, and 5.10.3 for more details about these options.

To use a saved run file, or to modify a saved run file, click on the “Recent” tab. A list of saved run files will be displayed. Left-click on a run file to select it, and then click on the “Open” button.

To use a Q Protocol, click on the “Protocols” tab. A list of Q Protocols will be displayed, left-click on a run file to select it, and then click on the “Open” button. Alternatively, double-click on the run file to open it directly.

4. The main software window will open. See Section 5.3 for a description of the features of the main software window.

6.2 Using the UV lamp

Warning: An electronic interlock ensures that the instrument lid is closed during UV lamp operation. Under no circumstances should this interlock be disabled.

Before operating the UV lamp, remove all worktable accessories. This ensures that the worktable has maximum exposure.

To operate the UV lamp:

1. Remove all plates and accessories from the worktable.
Note: The tip ejector must be present.
2. Close the instrument lid.
3. Click on the  icon on the toolbar.
4. The “UV Lamp Control” dialog box will appear.

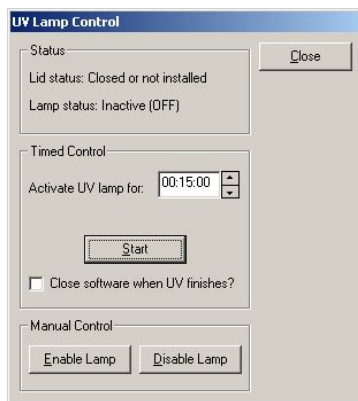

Lid status	Indicates whether the instrument lid is “Closed or not installed” or “Open”.
Lamp status	Indicates whether the lamp is “Inactive (OFF)” or “Active (ON)”
Activate lamp for	Enables the user to set UV lamp exposure times of between 1 second and 30 minutes, using the arrows.
Start	Initiates UV lamp operation.
Close software when UV finishes?	Shuts down the QIAgility Software when UV lamp operation is complete.
Enable Lamp	Switches the UV lamp on.
Disable Lamp	Switches the UV lamp off.
Close	Closes the “UV Lamp Control” dialog box.



5. The UV lamp can be enabled using timed control or manual control. Under manual control the instrument arm does not move and shadowing will result. Under timed control, the instrument arm moves between 2 locations in 5 s intervals.

6. If using timed control, define the exposure time and click on the “Start” button. If using manual control, click on the “Enable Lamp” button.
7. A message box will appear. Read it carefully.
8. Click on the “Yes” button to start operation of the UV lamp.
Note: To switch the UV lamp off, click on the “Stop” button.

6.3 Operating the HEPA filter

When the HEPA filter is switched off, the HEPA filter icon in the toolbar appears red.

To operate the HEPA filter:

1. Click on the  icon in the toolbar.
2. The HEPA filter will switch on and the HEPA filter icon in the toolbar will appear green.
3. To switch the HEPA filter off, click on the  icon in the toolbar.

6.4 Executing a run

6.4.1 Q Protocols

Q Protocols are run files which have been developed to directly facilitate specific PCR applications. Q Protocols are installed within the “QProtocols” subfolder. To access this folder, select “Installation directory of QIAgility Software\QIAgility\QProtocols” (e.g., C:\Program Files\QIAgility\QProtocols).

Q Protocols are locked. Edit access is only permitted to update the lab notebook, set tip availability, modify sample banks and assign plate IDs/barcodes and well IDs/barcodes to sample/reaction wells defined in the run.

A loaded Q Protocol cannot be saved as a Q Protocol. It can be saved as a locked “User-Developed Protocol” or an unlocked normal run file. If further adjustments are required,

the Q Protocol must be unlocked and saved as a normal run file.

If the user attempts to overwrite an existing Q Protocol, the following message will appear.

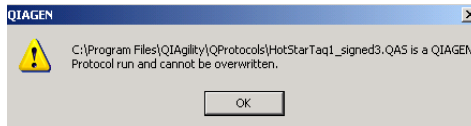

Using a Q Protocol

1. Start the QIAgility software, as outlined in Section 5.1.
Note: If the QIAgility software is already operating, press the  icon in the toolbar.
2. The following screen will appear.



3. The welcome dialog will open.

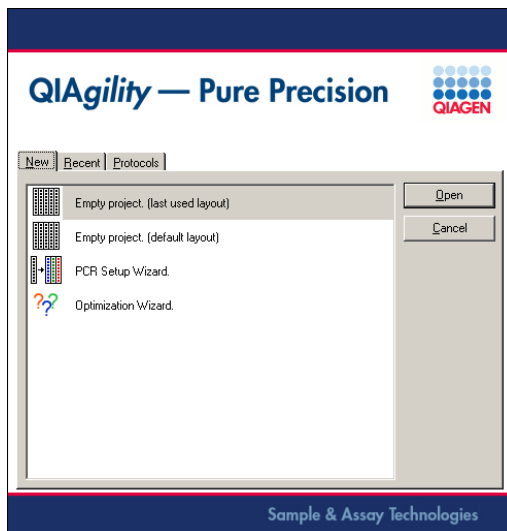

4. Select the "Protocols" tab. All Q Protocols that are saved in the appropriate folder (i.e. "QProtocols") will be displayed.

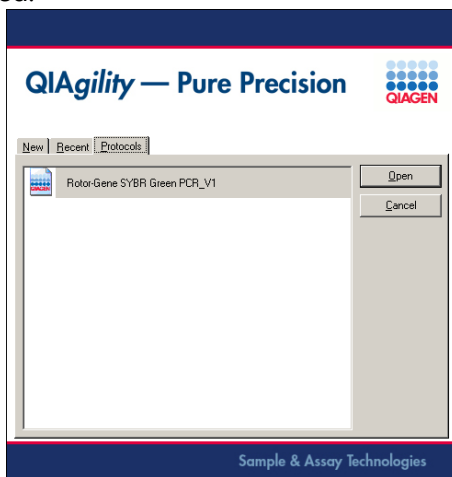

5. Select the desired Q Protocol.
6. Click on the "Open" button.
7. A description of the Q Protocol will appear.

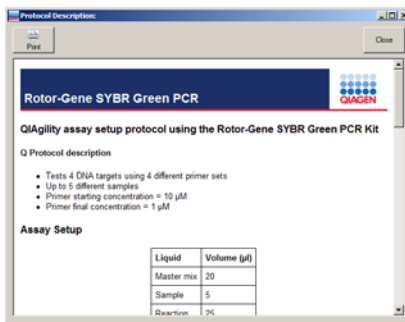

8. Review the description and then click on the “Close” button.
9. If necessary, modify the Q Protocol according to your needs. The user can adjust the lab notebook, set tip availability (see Section 5.7.2), modify sample banks (see Section 5.8.1), assign plate IDs/barcodes (see Sections 5.9.5, 5.9.6, and 5.9.7) and assign well IDs/barcodes to sample/reaction wells (see Sections 5.9.5, 5.9.6, and 5.9.7).

6.4.2 Selecting a saved run file

To open a saved run file:

1. Select “File/Open”, or click on the  icon.

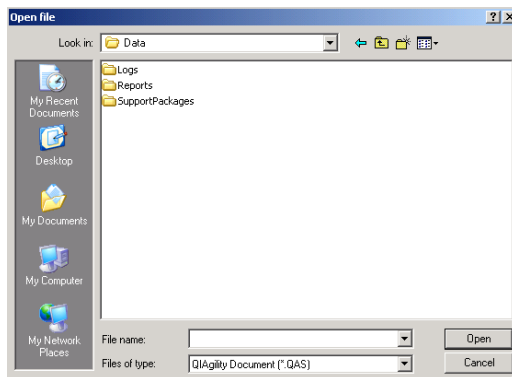

2. Select a file and then click on the “Open” button.

To open a recently used run file using the toolbar:

1. Click on the  icon on the toolbar.

2. Select the "Recent" tab.

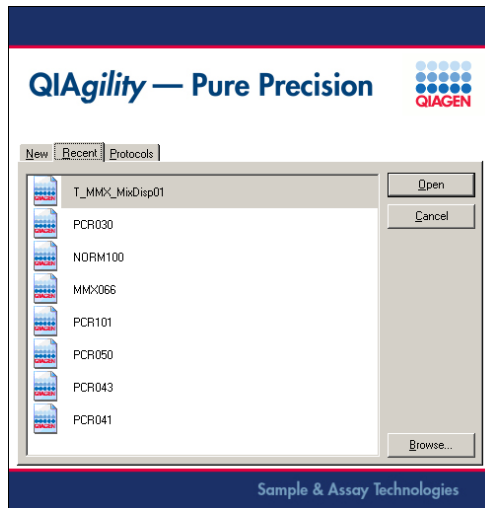

3. Select a run file from the list and then click on the "Open" button.

To open a recently used file from the "File" menu:

1. Select "File" from the menu bar. Recently used run files are listed in the "File" menu.

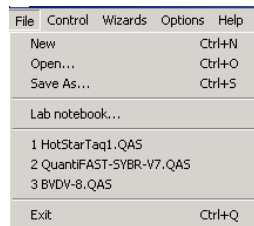

2. Select one of these files.

6.4.3 Creating a new run file

There are 2 wizards, "PCR Setup Wizard" and "Optimisation Wizard", which can be used to create a new run file. Alternatively, a new file can be created by selecting "Empty Project (last used layout)" or "Empty Project (default layout)" when the software is started.

Note: Once a run file has been created, it can be checked using “Virtual Mode” operation. See Section 5.1 and 5.2 for more details about “Virtual Mode” operation.

See Sections 5.10.1, 5.10.2, and 5.10.3 for information about how to create a new run file, either using a wizard, or using the “Empty Project” (last used layout) or “Empty Project (default layout)” function.

6.4.4 Preparing the worktable

After loading the desired run file, the worktable must be prepared. The pre-run report provides details about the location and amount/volume of consumables and liquids that are required on the worktable for completion of the loaded run file. To view the pre-run report, select “Wizards/Generate report”. See Section 6.7.1 for more details about the pre-run report.

Note: Before preparing the worktable, ensure that the tip disposal box has sufficient space to accommodate additional used tips that will be produced from the run.

1. Prepare the reagents and samples.
2. Open the instrument lid.
3. If tips are available on the worktable, check whether these are the correct tip types and whether sufficient tips are available. If not, add more tips to the worktable and make these available in the software. See Section 5.7.2 for more details about how to do this. The following picture outlines how to insert tips into Tip Rack Holders.

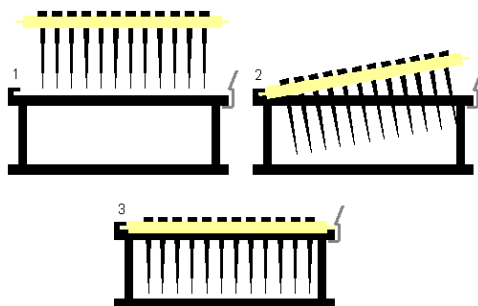

4. Place the correct plates on the worktable.
5. Load the correct plate height and plate position calibrations for each plate and Tip Rack Holder. See Sections 5.5.2, 7.1.2, and 7.1.3 for more details about how to do this.
6. Place the correct tubes in each plate on the worktable.
7. Add the correct volumes of reagent, diluent, standard, samples, and, if used, premixed master mix into the correct tubes on the worktable.

Note: To view the required volume of liquid, place the cursor over the source well. A hover box will appear which displays the required volume of liquid that the software has calculated. This volume includes the extra volume which allows for liquid recovery limitations and losses due to evaporation and tip contact during pipetting. Alternatively, view the pre-run report.

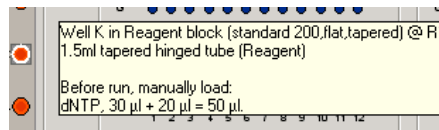

8. Close the instrument lid.

6.4.5 Starting a run

1. Click on the  icon on the toolbar, or select "Control/Start".
2. The "Save as" dialog box will appear. To save the run file, enter a name for the run file and click on the "Save" button. If the run file has already been saved, click on the "Cancel" button to continue.
3. The pre-run "Checklist" dialog box will appear.

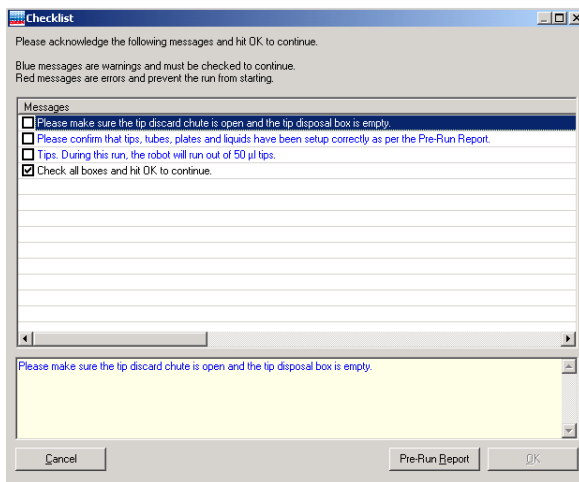

4. If the run has been set up correctly, the checklist will not list any warnings or errors other than those listed above. If errors are listed, user intervention is required before the run can be started. Select the boxes next to the warnings to continue.
5. Click on the “Pre-Run Report” button to view the pre-run report. Check the worktable setup.
6. Click on the “OK” button to start the run.
7. The location of the pipetting head will be highlighted on the software worktable in real time, and a summary of the progress of the run will be displayed in the right-hand pane. See Section 5.3.4.

6.5 Pausing/aborting a run

A run can be paused and aborted at any time.

Pauses will be logged in the post-run report. If the run is aborted, the instrument will discard the tip and return to its resting position.

To pause a run:

1. Click on the  icon in the toolbar, or select “Pause/Abort” from the “File” menu.

- The instrument will complete the current operation and will then pause. The following dialog box will appear.

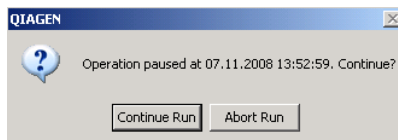

- Click on the "Continue Run" button to continue the run, or click on the "Abort Run" button to abort the run.
- The instrument lid must be closed to abort the run.

Note: A run will also be paused when the instrument lid is opened.

Note: The instrument does not stop immediately when the lid is opened. Therefore, wait until the Y-arm has stopped moving and the warning screen is displayed before continuing.

Note: An aborted run cannot be restarted from the point at which it was aborted.

6.6 Exception handling

If an exception (i.e., an error or warning) occurs during a run, an alarm will sound for 60 seconds, and then at 30 second intervals. A dialog box which contains information about the error will appear. This box has 4 buttons — "Abort run", "Retry operation", "Ignore error", and "Skip step". See Section 9.3 for more information about specific warnings and errors.

Abort run	Click this button to abort the run.
Retry operation	The instrument will discard the current tip. The Y-arm will move to its resting position. This provides access to the worktable, allowing the error to be resolved. Click on the "OK" button to continue with the run.
Ignore error	The instrument will continue with the run as normal.

Skip step The instrument will skip the step and continue with the run.

Exhausting tip supply during a run

If the tip supply is exhausted during a run, the instrument will pause to allow the user to replenish the tips. The “Replace Tips” dialog box will appear.

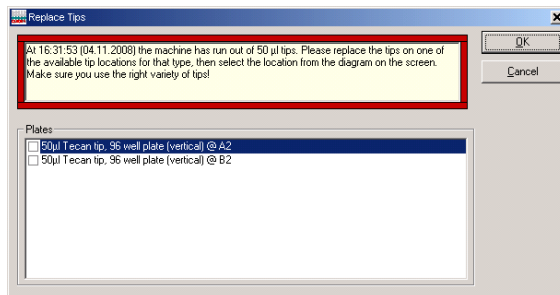

To replace the tips:

1. Add the correct tips to one of the available tip locations on the worktable.
2. Select the “Tip” plate where the tips have been replaced by checking the box next to the correct plate.
3. Click on the “OK” button to continue the run.

Note: If the “Cancel” button is selected, the run will be aborted.

6.7 Reports/log files

6.7.1 Pre-run report

The pre-run report is automatically generated before starting a run file. It contains the following information:

- Run file
- Software version
- Instrument details
- Run time (estimate)
- Protocol information

In addition, the pre-run report also contains detailed information about “Assay Setup”, “Robot table setup”, “Reaction steps/Task list”, and “Program Settings”.

The following options are available from the toolbar at the top of the pre-run report.



Prints the pre-run report.



Saves the pre-run report. Assign a file name, select a location, and then click on the “Save” button.



Opens a new e-mail message, which enables the pre-run report to be e-mailed.



Saves the pre-run report as a Word document. Assign a file name, select a location, and then click on the “Save” button.



Closes the pre-run report.

Generating the pre-run report

To generate a pre-run report:

1. Open the run file for which the pre-run report will be generated.
2. If necessary, adjust the run file according to your needs.
3. Select “Wizards/Generate report”. The pre-run report will be displayed.

Alternatively, the pre-run report can be generated when starting a run. To do this:

1. Select the  icon from the toolbar.
2. The “Save file” dialog box will open.

3. Select a location in which to save the run file, and then click on the “Save” button. Alternatively, if no changes have been made, click on the “Cancel” button.
4. The pre-run “Checklist” dialog box will appear.

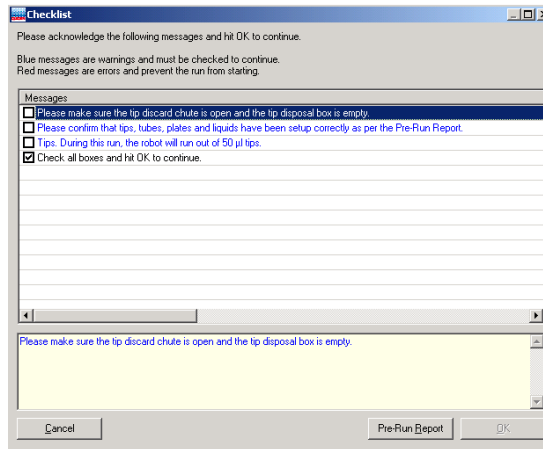

5. Click on the “Pre-Run Report” button. The pre-run report will be displayed.

6.7.2 Post-run report

Upon completion of a run, a “Post-run” report will appear. This report contains the same information as the “Pre-run report”, but also contains the following information:

Duration:

- Date
- Start time
- Completion time
- Run duration

Exceptions:

- Date and time of exception
- Instrument activity at time of exception
- Details of the exception
- User response

Note: Any exceptions are highlighted in the post-run report.

Reaction plate details

- Well number
- Well location
- Programmed final well contents
- Actual final well contents
- Volume pipetted (total to well)
- Final concentration
- Maximum working volume achieved
- Status ("OK" or "Error")

Options to "Print", "Save", "E-mail" or "Export" the report into a Word document are available via the toolbar at the top of the "Post-run Report".

The "Post-run report" is automatically saved in a subdirectory called "Reports" in the current run file save directory. The default directory is **C:\Program Files\QIAgility\Data**.

6.7.3 Log files and support packages

Log files

A new log file is generated when the software starts, when a run starts, or when a log file reaches 16 MB in size. The 8 most recent logs are stored.

Log files are saved under "selected installation directory"/Data/Logs (e.g., **C:\Program Files\QIAgility\Data\Logs**).

To view a log file:

1. Select "Help/Display log file" or press F11.
2. The log file will be displayed.
3. Items listed in red indicate an error. Items listed in green indicate the start/shutdown of the software and the start/end of a log file.

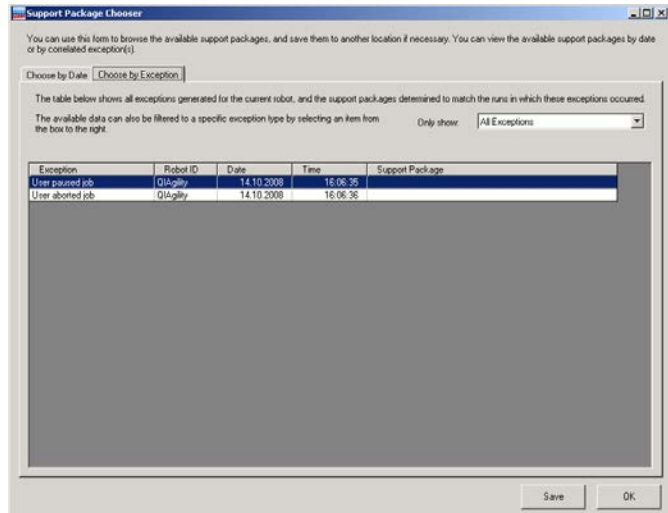

Choose by Date Sorts listed support packages by date.

Choose by Exception Sorts listed support packages by exception.

All Exceptions Displays all support packages which contain an exception.

User paused job Displays all support packages in which the user paused the run file.

User aborted job Displays all support packages in which the user aborted the run file.

- The support packages can be sorted by selecting "Choose by Date" and "Choose by Exception" tab. In addition, support packages can be viewed based on the type of exception. To do this, select "All Exceptions", "User paused job", or "User aborted job" from the drop-down menu.

6.8 Importing and exporting reaction/sample data

Sample and reaction data can be imported and exported. See Section 5.9.7. Extraction data from earlier purifications can be imported and used as sample data. In addition, data can be exported for use in downstream applications, for example with the Rotor-Gene Q.

6.9 Shutting down the software and the instrument

1. Click  in the top right corner of the screen, or select "File/Exit", to shut down the software.
2. If a run is still active, the software will display a warning message.

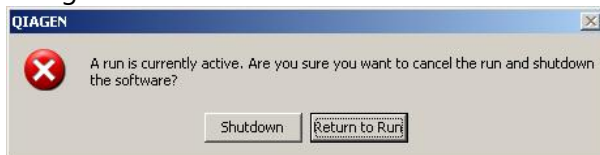

3. Select "Return to Run" if you want to cancel the shutdown process and finish the run.
4. Select "Shutdown" if you really want to stop the run immediately and proceed with the shutdown process.
5. If the current run file has already been saved, proceed to Step 8. If the current run file has not been saved, the following message will appear.

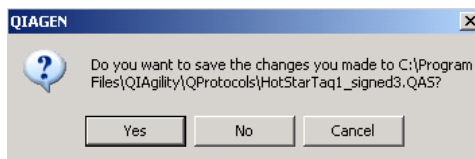

6. Select the "Yes" or "No" button.
7. If "Yes" is selected, the "Save File" dialog box will appear. Select a file location and then click on the "Save" button.

8. If the current run file has already been saved, the following message will appear.

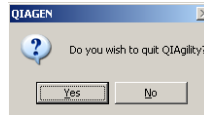

9. Click on the "Yes" button.
10. The following dialog box will appear.

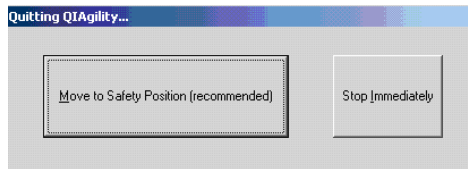

11. Select "Move to Safety Position (recommended)", or "Stop Immediately". See below for details about these options. If "Stop Immediately" was selected, proceed to step 11.
12. The software will now shut down. If "Move to Safety Position (recommended)" was selected, the robot will discard the tip, and the pipetting head will now move to a safe location. The following message will appear.

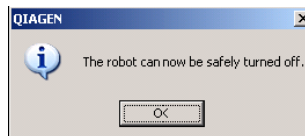

13. Click on the "OK" button.
14. Set the power switch of the QIAgility to the off position.

Moving to a safety position

This is the recommended method of shutting down the instrument. The instrument will discard the tip, complete its homing routine, and then the pipetting head will be lowered to a known safe location. The user is prompted when it is safe to switch the instrument off. All the instrument axes are disengaged and can be moved freely. As the instrument is

switched off a small click is heard as the pipetting head drops 1–2 mm further.

Shutting down immediately

This is a faster way of shutting down. The instrument axes remain engaged and the pipetting head remains in an upward position. If the head holds a tip it will not be discarded. As the instrument is switched off, the pipetting head will drop approximately 70 mm. This will not damage the instrument but may result in a pipet tip being picked up.

7 Instrument Setup and Calibration

Before starting any runs, the QIAgility must be calibrated. This section outlines the calibrations that must be performed.

If the QIAgility is moved, we recommend recalibrating the plate positions. Unless the pipetting mechanism has been serviced, or pipetted volumes are found to be inaccurate, there is no need to recalibrate the volume.

Note: If pipetted volumes are found to be inaccurate, please contact QIAGEN Technical Services.

7.1.1 Setup tip ejector

Before starting, ensure that the worktable is clear, except for the tip ejector.

Procedure

1. Select "Options/Robot setup/Set up tip ejector".
Alternatively, if tip ejector calibration is being performed for the first time, click on the "OK" button in the following dialog box.

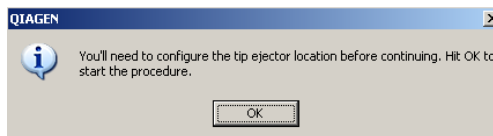

2. Review the following message.

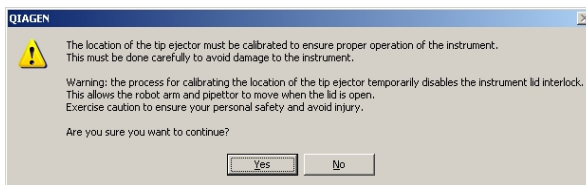

3. Click on the "Yes" button to continue with tip ejector calibration.
4. The "Tip Ejector Calibration" dialog box will appear.

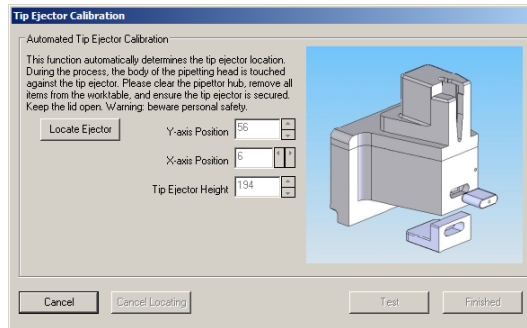

5. Click on the "Locate Ejector" button.

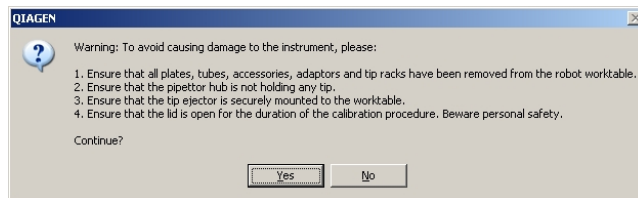

6. Open the instrument lid and ensure that the worktable has been cleared.
7. Click on the "Yes" button. The automated calibration procedure will start.
8. Once the X- and Y-axis positions have been located, the following message will appear.

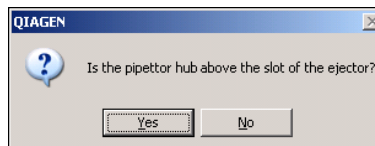

9. Check the pipetting hub position. If it is located correctly, click on the "Yes" button to continue. The Z-axis position will now be located. The "Tip Ejector Calibration" dialog box will reappear. Proceed to step 14.

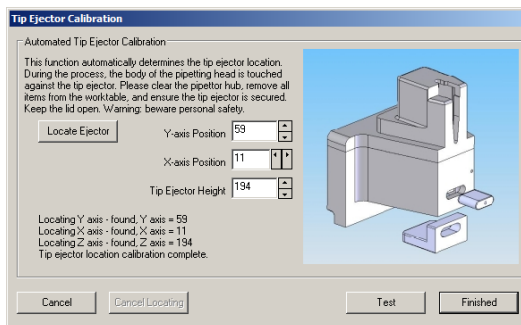

- If the pipetting hub is not correctly located, click on the "No" button. The following dialog box will appear.

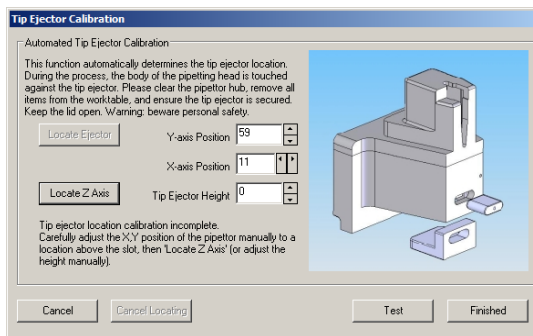

- Manually adjust the X- and Y-axis positions, using the arrows, and then click on the "Locate Z Axis" button.
- The following message box will appear.

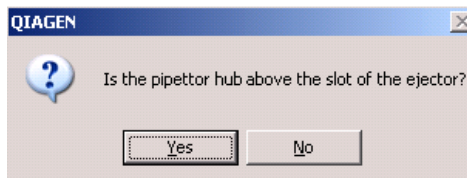

- Click on the "Yes" button. The instrument will now locate the Z-axis position.
- Click on the "Test" button, the following message box will appear.

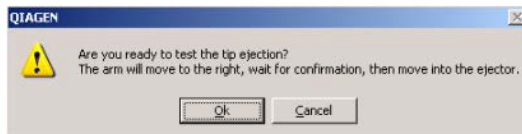

15. Click on the "OK" button.

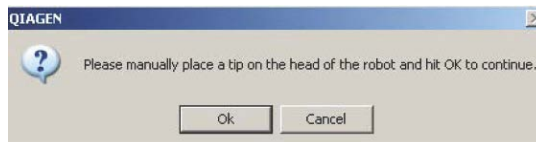

16. Place a tip onto the pipetting head, and then click on the "OK" button to continue.
17. The instrument will now locate the tip ejector and will eject the tip.
18. Click on the "Finished" button.
19. The following message box will appear.

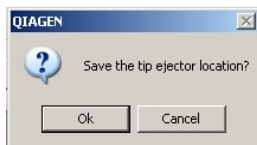

20. Click on the "OK" button to save the tip ejector calibration.

7.1.2 Calibrate plate positions

Before using a plate on the worktable, a position calibration must be performed. Plate position calibrations can be saved and reused.

Important: Tip Rack Holder calibrations must be performed before any other plate type can be calibrated.

Caution: The Y-arm will move during position calibration when the lid is raised. Do not click on any software buttons while parts of your body are within the instrument worktable.

Before starting the procedure:

- Open the instrument lid.

- Place plates to be calibrated onto the worktable.
 - Ensure that 200 µl tips are available in at least one Tip Rack Holder.
1. Select “Options/Robot Setup/Calibrate plate positions”.
 2. The “Set Alignment” dialog box will appear.

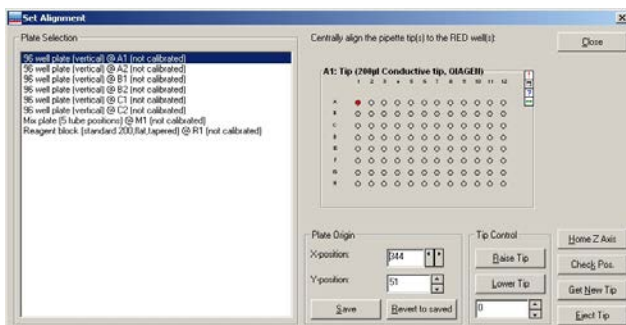

- | | |
|-----------------|--|
| Plate Selection | Lists the plates that are located on the instrument worktable. |
| X-position | Indicates the position of the pipetting head on the X-axis. During calibration, the objective is to set this to match the center position of the calibration well. |
| Y-position | Indicates the position of the pipetting head on the Y-axis. During calibration, the objective is to set this to match the center position of the calibration well. |
| Save | Saves the current X- and Y-positions as the calibration location for the plate. |
| Revert to saved | Restores the X- and Y-positions from the most recently saved values. |
| Raise tip | Raises the tip. |
| Lower tip | Lowers the tip. |
| Home Z Axis | Raises the pipetting head to the top (home) position. |

Check Pos.	Moves the pipetting head to the defined X- and Y-position to enable the user to visually inspect whether this corresponds to the center of the calibration well.
Get New Tip	Collects a new (200 µl) tip.
Eject Tip	Discards the tip that is currently on the pipetting head.

3. Select a plate from the "Plate Selection" list.
Note: Tip Rack Holders are listed as 96-well plates.
4. A schematic diagram of the selected plate is displayed on the right. Position calibration is performed using a 'calibration well'. This well is highlighted red.
5. Use the "Lower Tip" and "Raise Tip" buttons in the "Tip Control" panel to move the pipetting head so that it is just above the plate surface. Ensure that the tip is not in contact with the plate.
Note: If there is no tip attached, the pipetting head can only move to a limited Z-height (680). To obtain lower Z-height positions the instrument must pick up a tip. To do this, click on the "Get New Tip" button.
6. Adjust the "X-position" and "Y-position" in the "Plate Origin" panel so that the pipetting head is directly above the center of the calibration well. View the pipetting head from the front and from the side to ensure correct alignment.
7. Click on the "Save" button. The current position is now saved as the calibrated value. If desired, click on the "Check Pos" button to confirm that the correct position has been saved.
8. To perform position calibrations on other plates, repeat steps 3–7.
9. When position calibrations are complete, click on the "Close" button.

7.1.3 Calibrate plate heights

Plate height calibration should be performed after plate position calibration. It can be performed automatically or manually.

Automatic plate height calibration

Before starting the procedure:

- Ensure that 50 μ l tips are available, that the Tip Rack Holder is calibrated, and that the correct tips are set as available.
 - Ensure that empty tubes are placed in the first 4 wells of each plate.
1. Select "Options/Robot Setup/Calibrate plate height".
 2. The "Configure Plate Heights" dialog box will appear.

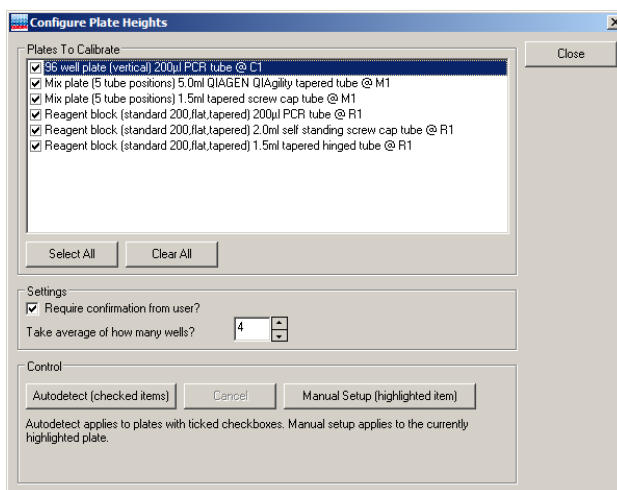

Plates to Calibrate Lists the plates that are currently located on the worktable.

Select All Selects all of the plates in the "Plates to Calibrate" list.

Clear All Deselects all of the plates in the "Plates to Calibrate" list.

Require confirmation from user?	Instructs the software to present a message to the user after automatic plate height calibration is performed. This enables the user to confirm the value to be recorded as the auto-detected height.
Take average of how many wells?	Defines the number of wells from which to take an average.
Autodetect (checked items)	Initiates the automatic plate height calibration operation. Automatic plate height calibration is performed only for the selected plates.
Abort	Aborts the current calibration activity.
Manual Setup (highlighted items)	Initiates the manual plate height calibration operation. Manual plate height calibration is performed only for the selected plate.

3. Check the boxes next to the plates to be calibrated in the “Plates to Calibrate” list. Alternatively, click on the “Select All” button to select all of the plates.

Note: Plates which have multiple segments (e.g., Reagent Blocks) are listed more than once, but with different tube types.

4. Define the number of wells from which to take an average. It is recommended that 4 wells are used to calculate the average.
5. Click on the “Autodetect (checked items)” button to initiate calibration.

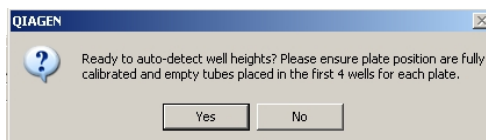

6. Review the message and click on the “Yes” button to continue.

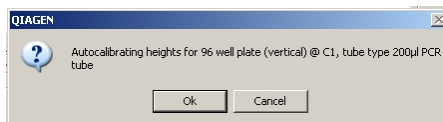

7. Click on the “OK” button to continue.
8. If “Require confirmation from user?” was selected, the following message will appear.

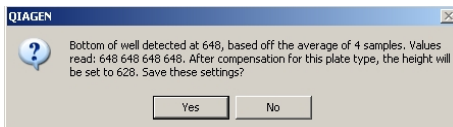

9. Click on the “Yes” button to accept the calibration, if the averages for a plate are within 10 units of each other. If the averages are not within 10 units of each other, click on the “No” button to reject the current calibration and then repeat steps 5–8.

Note: Before repeating the calibration, ensure that all tubes are sitting correctly and that the tips are not bent.

Note: If there is significant variation across the 4 samples, the following message box will appear. Click on the “OK” or the “Cancel” button.

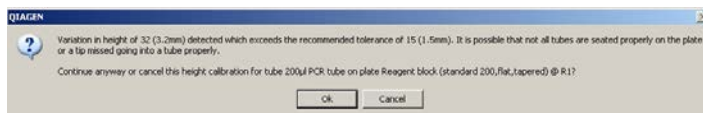

10. If more than one plate was selected in the “Plates to Calibrate” list, the instrument will calibrate each plate in turn. Repeat steps 6–9 for each plate.
11. When all calibrations are complete, click on the “Close” button.

Manual plate height calibration

1. Complete steps 1–4 of “Automatic plate height calibration”.
2. Click on the “Manual Setup (highlighted item)” button.
3. A dialog box will appear, click on the “Yes” button to continue.

- If the plate had a previous calibration, a dialog box will appear, asking whether to reset the Z-axis height. Click on the "Yes" button to reset the height, or click on the "No" button to retain the current setting. The "Adjust Height" dialog box will appear.

Caution: If the current setting is retained and the plate position is too high, the tip may jam into the plate and bend the tip.

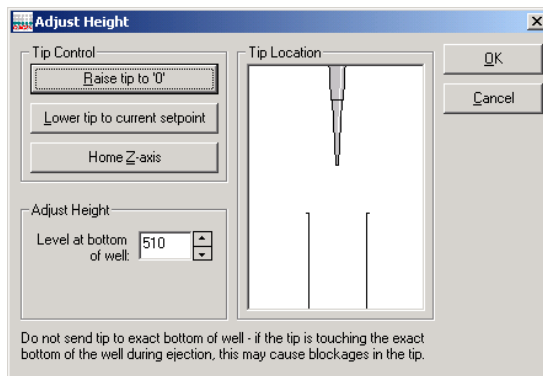

- | | |
|-------------------------------|---|
| Raise tip to "0" | Lifts the pipetting head to the current "0" position. |
| Lower tip to current setpoint | Places the pipetting head at the height that corresponds to the displayed "Level at bottom of well". |
| Home Z-axis | Lifts the pipetting head to the top (home) position and resets the "0" position. |
| Level at bottom of well | Indicates the proposed manual plate height calibration value — a Z distance measured from the "0" or home position. The goal of manual plate height calibration is to set this so that the tip is just above the base of the tube/well. |

- Adjust the height of the tip in the "Adjust Height" panel.

6. Use the up/down arrow buttons in the manual height calibration window to raise and lower the pipetting head.
7. To adjust the height correctly, the distance between the tip and the tube base must be adjusted as described above. In most cases it is not possible to see the distance between the tip and the base, the distance must be 'felt' by manually lifting the tube from its support plate.
8. If the tip makes forceful contact with the base of the tube/well, the "Level at bottom of well" does not reflect the true distance of the base of the tip from the home position. Use the "Home Z-axis" button to reset the "0" position and repeat steps 5–7, starting with a lower "Level at bottom of well" value to avoid driving the tip forcefully into the base of the well.
9. Click on the "OK" button when the correct height calibration has been set.
10. Click on the "Cancel" button when all calibrations are complete.

7.1.4 Optimal height calibration

For optimal height calibration, please refer to "Optimal plate height calibration" in Appendix F.

7.1.5 Calibrate tip offsets

It is recommended that this calibration is performed upon initial installation and when the user starts a new lot number of tips.

The collar size of 50 μ l and 200 μ l tips should be equal, but small variations sometimes exist.

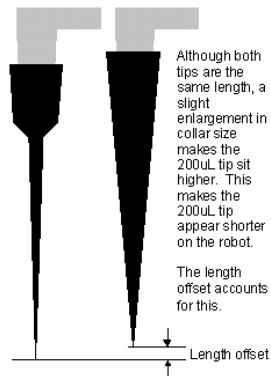

The tip offset calibration enables the software to automatically determine the correct height calibration for the 200 μ l tips, based on the height calibration that was performed with 50 μ l tips.

Before starting the procedure:

- Ensure that a plate with “Reaction” or “Mix” function, with well sizes large enough to accommodate 50 μ l and 200 μ l tips, is available — this plate must be position and height calibrated.
 - Place a tube in the first well of the reaction plate.
 - Ensure that 50 μ l and 200 μ l tips are available, that Tip Rack Holders are calibrated and that correct tips are set as available.
1. Select “Options/Robot setup/Calibrate tip offsets”.
 2. The “Configure tip offsets” dialog box will appear.

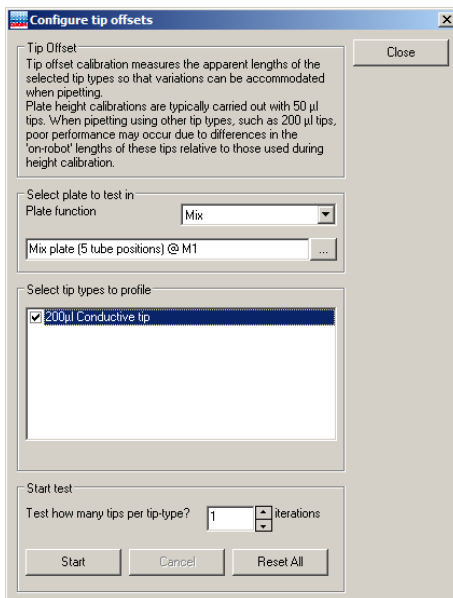

Plate function Defines the function of the plate in which tip offset calibration will be performed.



Opens the “Plate/well Selector” screen, which enables selection of the location of the plate in which tip offset calibration will be performed.

Select tip types to profile Lists the tip types to be calibrated — 200 µl conductive tips are selected by default.

Test how many tips per tip-type Defines the number of replicates that will be performed for the calibration of the selected tip type.

Start Starts the tip offset calibration.

Abort Aborts the current tip offset calibration.

Reset All Resets the tip offset calibration settings to the factory default values.

3. Select the correct plate function, from the drop-down menu, of the plate in which tip offset calibration will be performed.
4. Click on the  button. The "Plate/well Selector" screen will open. Left-click on a plate to select the location of the plate in which tip offset calibration will be performed.
5. Ensure that the correct tip type is selected in the "Select tip types to profile" panel.
6. Define the number of tips to be used to calculate the average offset.
7. Click on the "Start" button to start tip offset calibration.

7.1.6 Calibrate volumes

There is a direct relationship between the rotation of the motor shaft and the vertical movement of the pipet piston. Volume calibration defines the number of units that the P-axis motor must move to accurately deliver a given volume of liquid.

Volume calibration is performed using the "Volume Calibration Wizard". During installation of the QIAgility, the user should perform "Option 1" from the "Volume Calibration Wizard".

Note: Volume calibration must be done before the start of the first run on a newly-installed QIAgility. An error is shown at the start of the run if no volume calibration has been done.

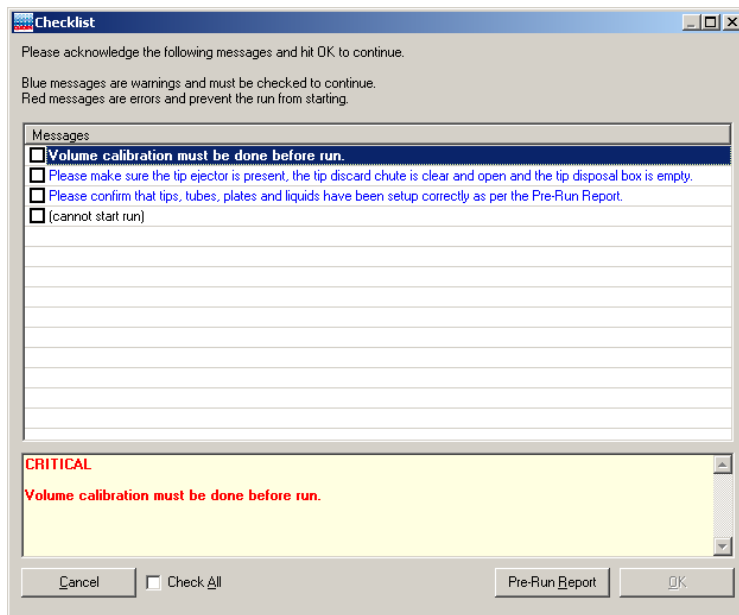

Opening the “Volume Calibration Wizard”

1. Open an “Empty Project (last used layout)” or “Empty Project (default layout)”, as outlined in steps 1–2 of Section 5.10.3.
2. Select “Options/Robot Setup/Calibrate Volumes”.
3. The “Volume Calibration Wizard” dialog box will appear. Options 1–3 will be displayed.

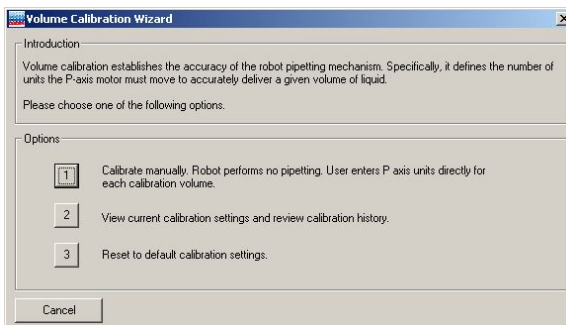

4. See the following sections for detailed information about Options 1–3.

Option 1

Use Option 1 to manually adjust the P-axis unit value for specific volumes. This method is used to enter the values supplied on the factory volume calibration report. Increasing the P-axis value increases the volume aspirated or dispensed. Conversely, decreasing the P-axis value decreases the volume aspirated or dispensed.

1. Select "Option 1" from the "Volume Calibration Wizard" dialog box.
2. The "Volume Calibration Wizard — Manual Calibration" dialog box will appear.

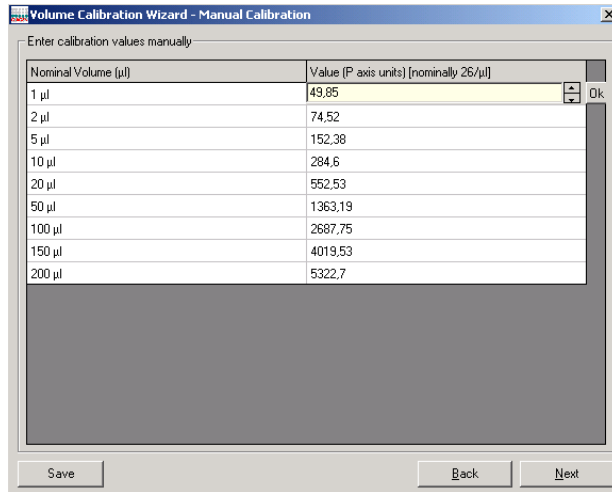

3. Click in the appropriate cell in the "Value (P axis units)" column to manually change the P-axis units.
4. Click on the "Next" button.



5. Click on the "Yes" button to continue.

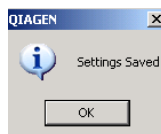

6. Click on the "OK" button.
7. The "Volume Calibration Wizard — History of Calibration Data" dialog box will appear.

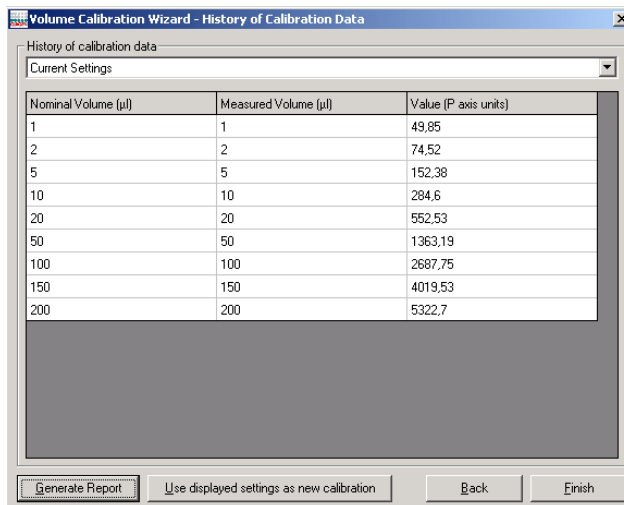

Generate Report

Opens a report which summarizes the displayed calibration settings.

Use displayed settings as new calibration

Updates the default volume calibration with the displayed calibration settings.

8. "Current Settings" are displayed by default. Saved calibration settings (up to 9) can be accessed via the drop-down menu. Select one of these calibrations to display the associated calibration data in the table.
9. To update the default volume calibration with the displayed calibration settings, click on the "Use displayed settings as new calibration" button.

10. If desired, click on the “Generate Report” button to open a window that displays the current calibration settings in a table format.

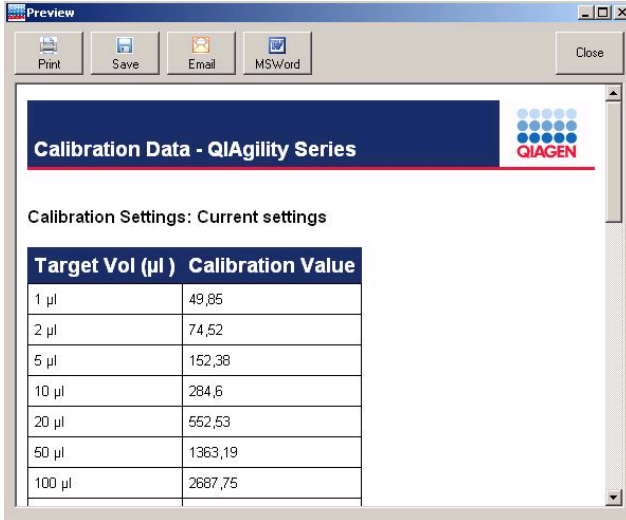

Target Vol (µl)	Calibration Value
1 µl	49,85
2 µl	74,52
5 µl	152,38
10 µl	284,6
20 µl	552,53
50 µl	1363,19
100 µl	2687,75

11. Click on the “Close” button to return to the “Volume Calibration Wizard — History of Calibration Data” dialog box.
12. Click on the “Finish” button to return to the main software window.

Option 2

Use Option 2 to view current calibration settings and to replace the current default calibration settings with previously saved calibration settings.

1. Select “Option 2” from the “Volume Calibration” dialog box.
2. The “Volume Calibration Wizard — History of Calibration Data” dialog box will open.
3. Proceed as for steps 8–12 of “Option 1”.

Option 3

Use Option 3 to reset the volume calibration to the factory default calibration settings. Current calibrations are automatically saved in the volume calibration history.

1. Select Option 3 from the "Volume Calibration" dialog box.
2. The following message will appear.

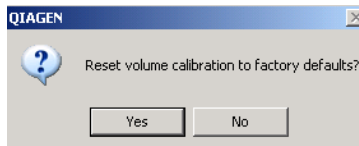

3. Click on the "Yes" button.
4. Click on the "Cancel" button in the "Volume Calibration" dialog box. The volume calibrations will now be updated with the factory default calibration settings.

This page intentionally left blank

8 Maintenance Procedures

The following maintenance procedures must be carried out to ensure reliable operation of the QIAgility:

- **Cleaning the QIAgility**
- **Minor corrective maintenance**

Following these procedures ensures that the QIAgility is free of dust and liquid spills.

Important: Switch the instrument off and disconnect the line power cord from the power outlet before servicing.

<p>WARNING/ CAUTION</p> 	<p>Risk of electric shock [W14]</p> <p>Do not open any panels on the QIAgility.</p> <p>Risk of personal injury and material damage</p> <p>Only perform maintenance that is specifically described in this user manual.</p>
--	---

Servicing

The QIAgility is supplied with a warranty that lasts for 1 year, beginning on the date of shipment. The warranty includes all repairs due to mechanical breakdown. Application development, software upgrades, accessories, and disposable items are not included in the warranty.

QIAGEN offers comprehensive Service Support Agreements, including Warranty Extensions, Full Cover Support Agreements, and instrument/application training, including on-site installation. Service Support Agreements maximize productivity and ensure high performance from your instrument. In addition, service histories are fully documented and all parts are certified and guaranteed.

Contact your local QIAGEN Field Service Specialist or your local distributor for more information about flexible Service Support Agreements from QIAGEN.

8.1 Regular maintenance

8.1.1 Cleaning the QIAgility

CAUTION 	Damage to the instrument [C4] Do not use solvents, or reagents containing acids, alkalis, or abrasives to clean the QIAgility.
---	---

WARNING 	Risk of electric shock [W14] Do not open any panels on the QIAgility. Risk of personal injury and material damage Only perform maintenance that is specifically described in this user manual.
---	--

CAUTION 	Damage to the QIAgility lid [C5] Do not use alcohol, solvents, reagents containing acids, alkalis, or abrasives to clean the instrument lid. Alcohol will damage the lid. To clean the lid, use distilled water only.
---	--

CAUTION 	Damage to the QIAgility side panels [C6] Never clean the instrument side panels with alcohol or alcohol-based solutions.
---	---

Important: We recommend wiping the QIAgility with a damp cloth only. The following cleaning agents have been tested successfully: Mikrozyd® Liquid, Mikrozyd Wipes (Schülke & Mayr GmbH); DECON-QUAT® 100 (Veltek Associates, Inc.) (identical to Microcide SQ™; Global Biotechnologies, Inc.)

Important: The worktable inside the instrument should be cleaned using a moist, soft cloth. The following cleaning agents have been tested successfully: Lysetol® AF, Gigasept® AF (Schülke & Mayr GmbH); DECON-QUAT 100 (Veltek Associates, Inc.) (identical to Microcide SQ; Global Biotechnologies, Inc.).

Note: Do not wipe the rails. These rails support the pipetting head and allow it to slide backwards and forwards easily. Wiping the rails will remove the grease and make them more susceptible to rust.

8.2 Periodic maintenance

8.2.1 Decontaminating the QIAgility

To remove DNA/RNA from the worktable and to eliminate cross-contamination, the QIAgility must be routinely decontaminated. Proceed as follows:

1. Remove all loading blocks and the tip ejector chute from the worktable. Wash these in detergent and rinse with clean water.
2. Soak these components in TriGene (Medichem International; for more information, see www.medimark.co.uk), or one of the tested cleaning agents listed in Section 8.1.1 above, for 15–30 min.
3. Thoroughly rinse the components in nucleic acid-free water.
4. Briefly rinse with absolute ethanol and dry with a soft paper towel.
5. Spray the instrument worktable with TriGene, or one of the tested worktable cleaning agents listed above, and allow to stand for 15–30 min. Wipe away with clean paper towels.
6. Spray the worktable the nucleic acid-free water and dry with clean paper towels. Repeat this 3 times.
7. Spray the worktable with TriGene, or one of the tested worktable cleaning agents listed above, and allow to air dry.
8. Return all components to the worktable and close the hood.
9. If fitted, switch on the optional UV lamp for 15 min.

8.2.2 Removing and replacing the tip ejector chute

Removing the tip ejector chute

1. Open the lid.



2. Grasp the chain connected to the tip ejector chute.
3. Using the chain, pull out the sliding security bolt.



4. Remove the tip ejector/tip ejector chute.

Replacing the tip ejector chute

1. Open the lid.
2. Replace the tip ejector chute.



3. Press the sliding security bolt into the side slot opening.

8.2.3 Replacing the HEPA filter

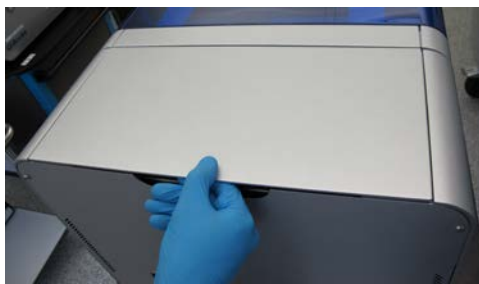

1. Lift the HEPA filter lid section.

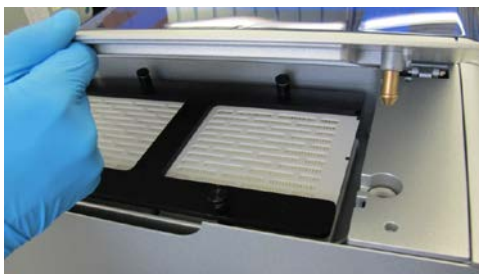

2. Remove the lid.
3. Unscrew the 4 thumb screws.
4. Remove the "H" Frame.
5. Remove the HEPA filters.
6. Replace the HEPA filters and reassemble.

This page intentionally left blank

9 Troubleshooting

9.1 System setup

Comments and suggestions

Instrument does not turn on

- a) Power cord not connected Check the power connection.
- b) Fuse blown Replace the fuse.

Computer software cannot communicate with system

- a) System is connect via RS-232 Under Windows 10 the RS232 port is not working
- b) Incorrect COM port settings Check the COM port setting. If the instrument is connected to the incorrect COM port the software will start in "Virtual Mode". See Sections 4.5 and 5.11.

QIAgility Software does not launch

- a) QIAgility Software not installed Install the QIAgility Software. See Section 4.6
- b) Old version of Microsoft Windows The QIAgility Software operates with Windows XP Professional or Windows 7. See Section 3.4.

9.2 Operation

Comments and suggestions

Running out of master mix

- | | |
|--|---|
| a) Master mix remains in the tube after completion of the run, but insufficient volume of master mix was delivered to the last reactions aliquoted | Ensure that the height calibration of the master mix tube is set correctly. Use manual height calibration to get a setting closer to the tube base without touching. |
| b) Correct initial volume was supplied or made but all master mix is consumed before all reactions are made | The pipettor may be aspirating larger volumes than expected. Ensure that the volume calibration data are correct and have been configured properly.

Tip reuse causes greater liquid losses on the insides of tips due to capillary and surface tension effects. Disable tip reuse.

Master mix may be viscous and build up on the outside of tips, causing larger losses. Increase the master mix extra volume configuration. See Section 5.6.3. |
| c) Source reagent remains in the tube after completion of the run, but the master mix has run out before all reactions aliquoted | Ensure that the height calibration of all reagent wells used for construction of the master mix is set correctly. Use manual height calibration to get a setting closer to the tube base without touching. |

Uneven levels in reaction tubes

- | | |
|--|---|
| a) Air bubbles trapped in sample tubes or master mix tubes | The liquid-level sensor functions equally well on air bubbles or the liquid surface. Centrifuge the sample plate to remove air bubbles. |
|--|---|

Comments and suggestions

- | | | |
|----|---|---|
| b) | Air bubbles appear in reaction tubes | Air volumes for dispense are too high. Reduce tip air intake volumes. |
| c) | Liquid droplets appear on reaction tubes above the liquid surface | The tip is colliding with the base of the tube causing liquid ejected under pressure to spray when the tip is retracted. Height calibration needs to be raised to prevent tip contact with the tube base during dispense. |
| d) | None of the above | Pipettor is operating erratically and may be clogged. Organize a service for the pipettor. |

Software locks or crashes

- | | |
|---|---|
| Screen savers and power save modes not disabled on the computer | Disable screen savers and power save modes on the computer. |
|---|---|

Z-axis not rising after power has been switched on

- | | | |
|----|--|--|
| a) | Power cords not securely plugged in | Ensure that all power cords are securely plugged in, then try switching the instrument on again. |
| b) | An internal fault on the instrument has occurred | Contact QIAGEN Technical Services. |

Replicates do not provide high reproducibility

- | | | |
|----|---|--|
| a) | Incorrect volumes entered for each reagent | Insert the correct volumes for each reagent. |
| b) | Master mix insufficiently mixed | Increase the number of mixes or use the "Wait for confirmation after creating mix" option and manually mix the master mix. |
| c) | Less than 5 µl DNA template used in reactions | It is recommended to use at least 5 µl DNA template is used in reactions. |

Comments and suggestions

- d) Air bubbles trapped in sample tubes Centrifuge the sample plate to remove air bubbles.

Software is very slow

- a) Virus scanners running on the computer Disable virus scanners on the computer.
- b) Long reaction list A long reaction list will cause the software to significantly slow down.

Instrument pipets in mid-air or pipets no liquid

- Level sensor malfunction Static electricity on the plasticware may be interfering with operation of the liquid-level sensor. Generate a support package and contact QIAGEN Technical Services.

Liquid in source well, but received "Insufficient Liquid" error message

- a) Incorrect tip configuration The instrument may have been configured to pick up tips that were not present in the Tip Rack Holder. Ensure that tip configuration is correct.
- b) Incorrect plate height calibration If the plate height calibration is too high, the tip cannot reach low enough into the tube to aspirate all the fluid. Ensure that plate height calibration is correct.
- c) Physical plate does not match model selected in software Software uses models of tubes and wells to translate the detected liquid surface height into a volume. When the wells or tubes are physically different than the model chosen, the volume calculated may be much lower than the actual volume present, causing aspiration steps to fail. Ensure the plate chosen in the software matches the physical plate. Consider disabling the "Detect insufficient volume on aspirate" advanced setting (see Appendix F).

Error messages recorded in post-run report, but the run was completed

Comments and suggestions

- | | |
|---|---|
| a) Volumes of reagents or samples below the minimum volume which is required for liquid-level sensing function. | If liquid was not detected, an error is recorded in the post-run report.

Add an extra 20 µl volume as required. Alternatively, dilute samples and reagents and pipet larger volumes rather than pipetting small volumes of concentrated solutions. |
|---|---|

A non-readable error message is received when the software is started

- | | |
|---|---|
| Correct plate definitions not installed | Uninstall and then reinstall the software. See Section 4.6. |
|---|---|

Software does not start and the “A required library file is not correctly installed or registered” error message is displayed

- | | |
|---|--|
| Present version of the software conflicts with an older version of the software | Reinstall the most recent version of the QIAgility software. |
|---|--|

Software running incorrectly with a “Software error: aborting” error message

- | | |
|--|---|
| Communications channel to the instrument being interrupted | Ensure that no other devices (e.g., modems) are attempting to use the same serial port as the instrument.

Alternatively, configure the instrument to use to a different serial port. |
|--|---|

9.3 Warnings and errors

9.3.1 Warning and error messages

Warnings and errors are indicated by the  symbol in the toolbar. In addition, warning (blue) or error (red) messages are listed in the pre-start checklist.

Click on the  icon to view a message describing the error or warning.

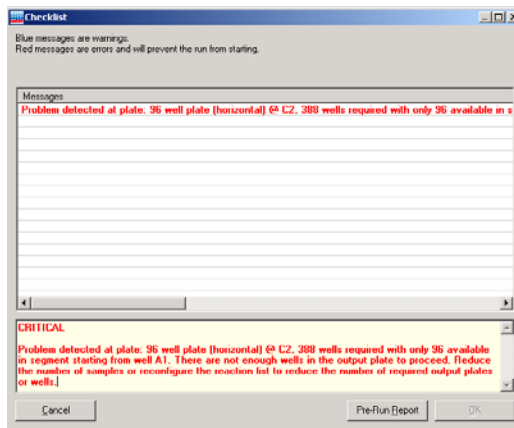

The run can commence with active warning messages, but this may lead to erroneous results.

Note: Warnings and errors are logged in the post-run report and in any support packages.

Warnings

Not enough small tips	There is an insufficient supply of 50 μ l tips.
Not enough large tips	There is an insufficient supply of 200 μ l tips.
Well too full	Too much liquid will be ejected into a well.
Well too small	A well cannot contain sufficient liquid to supply the run.
Eject volume too low	A volume of less than 5 μ l is programmed to be ejected into a dry well.
Will contaminate	The run contains reaction elements that will contaminate sample wells.

Volume too small	The run requires a volume of less than 1 μ l to be pipetted.
Multi eject	The run is set up with multi-eject functionality which can lead to reduced precision.
Master mix extra volume too small	The master mix extra volume is set to prepare a total extra volume that is lower than the extra volume recommended to avoid shortages.
Standards volume too high	An instrument-prepared standard well has a volume that is too large for a 200 μ l tip to mix effectively.
Speed not set	A speed parameter has not been set. Default settings will be used.
Air intake limits	The maximum volume that can be pipetted is limited by the amount of preaspirated air.
More than one sample added	Two or more different samples are added to a single reaction well.

Errors

Not enough output wells	There are not enough output wells in the reaction plate.
Too many standards	The number of programmed standards exceeds the maximum number of standards. The software can accommodate a maximum of 16 dilution series.
Invalid sample config	Sample banks are incorrectly configured.
Operation impossible	A reaction in the "Reaction List" cannot be performed.

Dilution out of range	The sample and target concentration are set to values that are not achievable.
Bad plate config	A plate configuration is not usable.
Reagent name	Problems with reagent naming in the "Optimisation Wizard" have occurred.
Non-unique tip type for volume	The correct tips for the required volume are not available.
Volume calibration must be done before run	Volume calibration must be done before a run can be started in these situations: New installation of instrument After pipettor service

9.3.2 Instrument error codes

All instrument errors are associated with an error number. All error numbers start with 40000. If an instrument error occurs, immediately save a support package and contact QIAGEN Technical Services. See Section 6.7.3 for details about how to save a support package.

Instrument error codes

1	FIFO over run error
2	Bad checksum error
3	Bad axis number used when an axis number is not supported by command.
4	Instrument is sent an unknown command.
5	Vacuum sensor cannot sense vacuum.
6	An axis is not enabled.
7	Tip sensor did not detect liquid.

8	Tip sensor could not be reset.
9	Home switch could not be found within limit.
10	82C55 I/O pins are unstable.
11	An error has occurred in SPI coms.
18	Error reading accessory EEPROM.
129	An invalid axis was specified.
130	The instrument did not respond with the first reply.
131	The instrument did not respond with a second reply.
132	The COM port has problems.
133	The micro firmware is mismatched.
134	An invalid COM port was chosen.
135	An attempt was made to move an axis beyond its limit.
136	Too many replies were specified in send Packet.
137	An incorrect checksum was encountered in a received packet.
138	The first reply was corrupt.
139	The second reply was corrupt.
140	The local receive FIFO overflowed.
141	An incorrect number of replies was received.
142	A specified packet ID could not be found in collection.

143	A specified accessory port number does not exist.
144	A specified accessory port is unoccupied.
145	An unknown accessory was detected.
146	A bad temperature reading was taken.
147	A bad packet length was received.
148	More data was received while processing.

9.4 Self diagnostic tools

These tests are designed to collect information to help with troubleshooting.

Note: These tests should only be performed by experienced users.

Warning: Before conducting self diagnostic tests, remove all plates, loading blocks and the tip ejector from the worktable. Failure to do this may result in permanent damage to the pipetting head.

1. Select "Help/Self diagnostic tools".
2. The "Robot Self Diagnostic Tools" dialog box will appear.

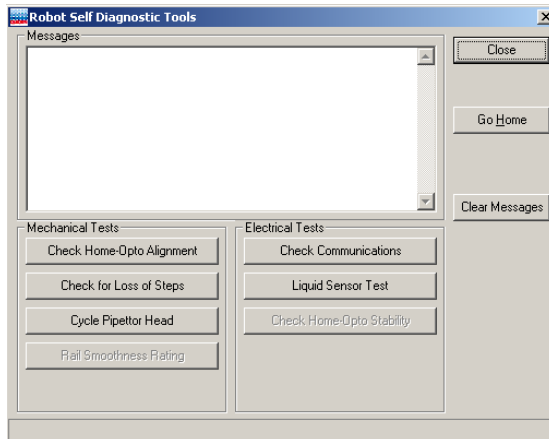

Check Home-Opto Alignment	See Section 9.4.1 for more details.
Check for Loss of Steps	See Section 9.4.1 for more details.
Cycle Pipettor Head	See Section 9.4.1 for more details.
Check Communications	See Section 9.4.2 for more details.
Liquid Sensor Test	See Section 9.4.2 for more details.
Close	Closes the dialog box.
Go Home	Homes all axes and resets the positional reference for the instrument for subsequent movements including tip ejection.
Clear Messages	Clears the content of the messages text box.

9.4.1 Mechanical tests

Check Home-Opto Alignment

This test ensures that the optical homes in X-, Y- and possibly Z-axes in QIAgility instruments are 3, 4, and 5 steps away from their L297 software home, respectively.

Check for loss of steps

This test establishes whether the instrument has reliable movement. The default iteration setting of 5 will take approximately 20–25 minutes to complete. Reported loss of steps on the P-axis can be ignored. Reported loss of steps on the Z-axis of +/- 8 steps is acceptable. If there are errors

on the X- or Y-axis, save a support package and contact QIAGEN Technical Services. See Section 6.7.3 for details about how to save a support package.

Cycle Pipettor Head

After calibration, or if the instrument has been unused for a long period of time, it is recommended to cycle the pipetting head. This helps to distribute the grease evenly. An iteration of 400 is recommended.

9.4.2 Electrical tests

Check Communications

USB cable bridge communication between the computer and the main controller of the instrument. SPI bridges communication between the main controller and slave controllers (i.e., accessories and axes controllers).

This test checks the integrity of both types of communications links in the system, exercising the channel to 4 internal axes and any accessories (if connected).

During this test, a SPIERROR(#11) error message is generated if the SPI link is unstable, or a BADRXCHKSUM(#137) error message appears if there is an unstable computer to instrument link. If no error message appears during the test, there is no problem with the communications links.

Liquid Sensor Test

This test checks that the liquid sensor circuitry is functioning correctly, so that it only triggers when the conductive tip touches the liquid.

This page intentionally left blank

10 Glossary

Term	Description
Diluent	Diluent is used to dilute the master mix, dilute samples, and create standard dilution series. It is assumed to be PCR-grade water. A diluent can only be assigned to a single well segment. Only 1 diluent tube can be assigned in a run file.
Lid	The instrument lid isolates the worktable, maintaining sample integrity, and acting as a safety mechanism.
Master mix	A master mix is a pooled group of reagents that can be added to a reaction plate. Master mix is always added to a reaction first because it normally constitutes the largest volume of the reaction.
Master Mix Block	The Master Mix Block is intended to hold diluent and master mix on the instrument worktable.
Menu bar	The menu bar contains 5 menus — “File”, “Control”, “Wizards”, “Options”, and “Help”. All software functions can be controlled from these menus.
Mode indicator	Indicates whether the instrument is operating in “Normal Mode” or “Virtual Mode”.
Normal mode	For “Normal Mode” operation the instrument must be switched on and connected to the computer. In “Normal Mode” operation, run files can be executed.
Power switch	A button located at the back of the QIAgility. It allows the user to switch the QIAgility on and off.
Q Protocol	Q Protocols are run files which have been developed by QIAGEN to directly facilitate specific PCR applications. Q Protocols are installed in the “QProtocols” subfolder

Glossary

Term	Description
Reaction	A reaction is the destination for the samples, master mixes, and reagents. Reactions can be assigned to a sample bank — this enables a reaction to be a component of a different reaction. A reaction that is a component of another reaction is an 'Intermediate' reaction.
Reagent	A reagent can be combined with other reagents to make a master mix, or added individually to a reaction. Reagents are always dispensed to reaction wells before samples.
Reagent Block	The Reagent Block is intended to hold reagents and standards on the instrument worktable.
Right-hand pane	The right-hand pane refers to the area at the right side of the software workspace. It provides access to options which relate to different plate functions. When a run is in progress, a progress report is displayed in the right-hand pane.
Run file	A run file defines the reaction setup.
Tip	Defines the function of a plate as a Tip Rack Holder. Tips in the Tip Rack Holder must be set to available or unavailable.
Tip chute	Used tips are ejected through the tip chute into a tip disposal box at the side of the instrument.
Tip Rack Holder	A Tip Rack Holder supports tips on the instrument worktable.
Tip disposal box	The tip disposal box collects used tips at the side of the instrument.
Toolbar	The toolbar consists of a series of icons, from which a range of software functions can be accessed.

Term	Description
Sample	A sample is always added to a reaction last. Samples must be assigned to a sample bank before they can be used in a reaction setup.
Software worktable	The software worktable visually simulates the instrument worktable. The 6 plate positions are labeled A1, A2, B1, B2, C1, and C2. Positions for the Master Mix Block and Reagent Block are labeled M1 and R1. When a run is in progress, the location of the pipetting head is highlighted on the software worktable.
Standard	A standard is a dilution series with known concentrations. Standards are treated like samples.
Virtual Mode	"Virtual Mode" enables run files to be developed and simulated, without actually performing the pipetting operations on the instrument. This is particularly useful for checking new run files. In "Virtual Mode" all software functions are enabled.
Worktable	The instrument worktable supports tips racks, plates/tubes, the Master Mix Block, and the Reagent Block.

This page intentionally left blank

Appendix A

Technical data

QIAGEN reserves the right to change specifications at any time.

Environmental conditions

Operating conditions

Power	100–240 V AC, 50–60 Hz, 250 VA Mains supply voltage fluctuations are not to exceed 10% of the nominal supply voltages.
Fuse	F5A 250 V fuse
Overvoltage category	II
Air temperature	15–30°C (59–86°F)
Relative humidity	40–70%
Altitude	Up to 2000 m (6500 ft.)
Place of operation	For indoor use only
Pollution level	2
Environmental class	3K2 (IEC 60721-3-3) 3M2 (IEC 60721-3-3)

Transportation conditions

Air temperature –25°C to 60°C (–13°F to 140°F) in manufacturer's package

Relative humidity Max. 75% (noncondensing)

Storage conditions

Air temperature 15°C to 30°C (59°F to 86°F) in manufacturer's package

Relative humidity Max. 75% (noncondensing)

Mechanical data and hardware features

Dimensions	Width: 54 cm (21.3 in.) Depth: 63 cm (24.8 in.) without cables 72 cm (28.3 in.) with cables Height: 45 cm (17.7 in.) lid closed 86 cm (33.9 in) lid open
Mass	41 kg (90.2 lb.) standard configuration
Capacity	Up to 96 samples per run
Software	QIAgility Software is supplied with the QIAgility System. Default protocols are available for use with the QIAgility Software and can be downloaded from www.qiagen.com/goto/QIAgility .

Waste Electrical and Electronic Equipment (WEEE)

This section provides information about disposal of waste electrical and electronic equipment by users.

The crossed-out wheeled bin symbol (see below) indicates that this product must not be disposed of with other waste; it must be taken to an approved treatment facility or to a designated collection point for recycling, according to local laws and regulations.

In the European Union, the European Directive 2002/96/EC on WEEE requires proper disposal of electrical and electronic equipment when it reaches its end of life.

The separate collection and recycling of waste electronic equipment at the time of disposal helps to conserve natural

resources and ensures that the product is recycled in a manner that protects human health and the environment.



Recycling can be provided by QIAGEN upon request at additional cost. In the European Union, in accordance with the specific WEEE recycling requirements, and where a replacement product is being supplied by QIAGEN, free recycling of its WEEE-marked electronic equipment is provided

To recycle electronic equipment, contact your local QIAGEN sales office for the required return form. Once the form is submitted, you will be contacted by QIAGEN either to request follow-up information for scheduling collection of the electronic waste or to provide you with an individual quote.

FCC declaration

The "United States Federal Communications Commission" (USFCC) (in 47 CFR 15. 105) declared that the users of this product must be informed of the following facts and circumstances.

"This device complies with part 15 of the FCC:

Operation is subject to the following two conditions: (1) This device may not cause harmful interference, and (2) this device must accept any interference received, including interference that may cause undesired operation."

"This Class A digital apparatus complies with Canadian ICES-0003."

The following statement applies to the products covered in this manual, unless otherwise specified herein. The statement for other products will appear in the accompanying documentation.

NOTE: This equipment has been tested and found to comply with the limits for a Class A digital device, pursuant to part 15 of the FCC Rules. These limits are designed to provide reasonable protection against harmful interference when the equipment is operated in a commercial environment. This equipment generates, uses, and can radiate radio frequency energy and, if not installed and used in accordance with the instruction manual, may cause harmful interference to radio communications. Operation of this equipment in a residential area is likely to cause harmful interference in which case the user will be required to correct the interference at his own expense.

QIAGEN GmbH Germany is not responsible for any radio television interference caused by unauthorized modifications of this equipment or the substitution or attachment of connection cables and equipment other than those specified by QIAGEN GmbH, Germany. The correction of interference caused by such unauthorized modification, substitution or attachment will be the responsibility of the user.

Declaration of conformity

Name and address of the company

**QIAGEN GmbH
QIAGEN Strasse 1
40724 Hilden
Germany**

We herewith declare under our sole responsibility that the product

QIAgility

meets all applicable requirements of the following European Directives

Low Voltage Directive (LVD) 2006/95/EC
Electromagnetic Compatibility Directive (EMC) 2004/108/EC

and the relevant harmonised standards

IEC 61010-1 (Ed.2.0)

IEC 61010-2-081 (Ed.1.0)

IEC 61326-1

IEC 61000-6-2

Hombrechtikon, February 8, 2011

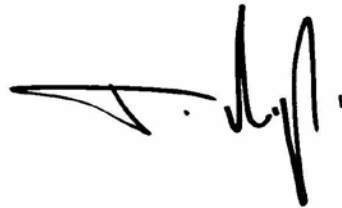

Pit Muggli

Senior Director, Quality & Compliance

This page intentionally left blank

Appendix B

Liability clause

QIAGEN shall be released from all obligations under its warranty in the event repairs or modifications are made by persons other than its own personnel, except in cases where the Company has given its written consent to perform such repairs or modifications.

All materials replaced under this warranty will be warranted only for the duration of the original warranty period, and in no case beyond the original expiration date of original warranty unless authorized in writing by an officer of the Company. Read-out devices, interfacing devices and associated software will be warranted only for the period offered by the original manufacturer of these products. Representations and warranties made by any person, including representatives of QIAGEN, which are inconsistent or in conflict with the conditions in this warranty shall not be binding upon the Company unless produced in writing and approved by an officer of QIAGEN.

This page intentionally left blank

Appendix C

Safety Information (French, FR)

1 Consignes de sécurité

Avant d'utiliser le QIAgility, il est impératif de lire attentivement ce manuel et de porter une attention particulière aux consignes de sécurité. Afin de garantir un fonctionnement de l'appareil en toute sécurité et de maintenir l'appareil en bon état de marche, il est impératif de suivre les instructions et consignes de sécurité fournies dans le présent manuel d'utilisation.





Les types d'informations de sécurité suivants sont fournis tout au long du manuel.

AVERTISSEMENT 	Le terme AVERTISSEMENT signale des situations risquant d'entraîner des accidents corporels dont l'utilisateur, ou d'autres personnes, pourraient être victime. Les détails concernant ces circonstances sont donnés dans un encadré identique à celui-ci.
---	---

ATTENTION 	Le terme ATTENTION signale des situations risquant d'entraîner des détériorations de l'appareil ou de tout autre matériel. Les détails concernant ces circonstances sont donnés dans un encadré identique à celui-ci.
--	---

Les conseils donnés dans ce manuel ont pour but de venir compléter les exigences de sécurité habituelles en vigueur dans le pays de l'utilisateur, et non de s'y substituer.

1.1 Utilisation appropriée

<p>AVERTISSEMENT/ ATTENTION</p> 	<p>Risque d'accident corporel et de détérioration du matériel [W1]</p> <p>L'utilisation inappropriée du QIAgility peut entraîner des accidents corporels ou une détérioration de l'appareil.</p> <p>L'utilisation du QIAgility est exclusivement réservée au personnel qualifié ayant été convenablement formé.</p> <p>La maintenance du QIAgility doit uniquement être effectuée par des spécialistes du Service Après-Vente QIAGEN.</p>
<p>AVERTISSEMENT/ ATTENTION</p> 	<p>Risque de surchauffe [W2]</p> <p>Afin de garantir une bonne ventilation, laisser un dégagement d'au moins 10 cm sur les côtés et à l'arrière du QIAgility. Les fentes et les ouvertures qui assurent la ventilation de l'appareil ne doivent pas être obstruées.</p>
<p>AVERTISSEMENT/ ATTENTION</p> 	<p>Risque d'accident corporel et de détérioration du matériel [W3]</p> <p>Le QIAgility est trop lourd pour être soulevé par une seule personne. Afin d'éviter tout accident corporel et toute détérioration du matériel, ne pas soulever l'appareil seul.</p>
<p>AVERTISSEMENT/ ATTENTION</p> 	<p>Risque d'accident corporel et de détérioration du matériel [W4]</p> <p>Ne pas essayer de déplacer le QIAgility pendant qu'il est en marche.</p>

<p>AVERTISSEMENT/ ATTENTION</p> 	<p>Atmosphère explosive [W5] Le QIAgility n'est pas conçu pour être utilisé dans une atmosphère explosive.</p>
<p>AVERTISSEMENT/ ATTENTION</p> 	<p>Risque d'explosion [W6] Le QIAgility a été conçu pour l'utilisation des réactifs et substances fournis par les kits QIAGEN. L'utilisation de réactifs et de substances autres que celles indiquées peut entraîner un risque d'incendie ou d'explosion.</p>
<p>ATTENTION</p> 	<p>Détérioration de l'appareil [C1] La lumière directe du soleil peut décolorer les pièces de l'appareil et abîmer les éléments en plastique. Tenir le QIAgility à l'abri de la lumière directe du soleil.</p>
<p>ATTENTION</p> 	<p>Détérioration de l'appareil [C2] Éviter de renverser de l'eau ou des produits chimiques sur le QIAgility. La détérioration de l'appareil dû au déversement de liquides annule la garantie.</p>
<p>AVERTISSEMENT</p> 	<p>Risque d'accident corporel [W7] Pendant les étapes de calibration des positions, le bras robotisé se déplace alors que le capot de l'appareil est relevé. Ne jamais actionner ou cliquer sur aucunes touches tant que des parties du corps se trouvent dans l'enceinte de l'appareil.</p>

En cas d'urgence, éteindre le QIAgility à l'aide de l'interrupteur d'alimentation situé à l'arrière de l'appareil et débrancher le cordon d'alimentation de la prise de courant.

1.2 Sécurité électrique

Avant l'entretien, débrancher le cordon d'alimentation de la prise de courant.

AVERTISSEMENT 	Danger électrique [W8] Toute interruption du conducteur de protection (conducteur de terre/de masse) à l'intérieur ou à l'extérieur de l'appareil ou toute déconnexion de la borne du conducteur de protection est susceptible de rendre l'appareil dangereux. Toute interruption intentionnelle est interdite. Tensions mortelles à l'intérieur de l'appareil. Lorsque l'appareil est relié à l'alimentation, les bornes peuvent être sous tension et l'ouverture de capots de l'appareil ou le retrait de pièces risque d'exposer des éléments sous tension.
---	---

AVERTISSEMENT 	Danger d'irradiation UV [W9] Un dispositif électronique de verrouillage empêche la lampe UV de fonctionner tant que le capot de l'appareil est ouvert. Ce dispositif ne doit en aucun cas être désactivé.
---	--

Afin que le QIAgility fonctionne de manière satisfaisante et en toute sécurité, suivre les conseils suivants :

- Le cordon d'alimentation de l'appareil doit être branché sur une prise d'alimentation munie d'un conducteur de protection (terre/masse).
- Ne pas régler ni remplacer les pièces internes à l'instrument.
- Ne pas faire fonctionner l'appareil si des capots ou des pièces ont été retirés.
- En cas de déversement de liquides à l'intérieur de l'appareil, débrancher celui-ci de la prise d'alimentation et contacter les Services techniques de QIAGEN.
- Si l'appareil présente un danger électrique, empêcher le reste du personnel de s'en servir et contacter les

Services Techniques de QIAGEN. L'appareil peut présenter un danger électrique dans les cas suivants :

- Le cordon d'alimentation présente des signes de détérioration.
- L'appareil a été stocké pendant une longue période dans des conditions non conformes à celles énoncées dans l'Annexe A.
- L'appareil a subi des chocs sévères durant le transport.

1.3 Sécurité biologique

Les spécimens et les réactifs contenant des matières provenant d'êtres humains doivent être considérés comme potentiellement infectieux. Utilisez des procédures de laboratoire sûres comme décrit dans des publications telles que *Biosafety in Microbiological and Biomedical Laboratories*, HHS (www.cdc.gov/biosafety/publications).

1.3.1 Échantillons

Les échantillons peuvent contenir des agents infectieux. Vous devez connaître le risque que de tels agents représentent pour la santé et devez utiliser, stocker et éliminer ces échantillons conformément aux règles de sécurité nécessaires.

<p>AVERTISSEMENT</p> 	<p>Échantillons contenant des agents infectieux^[W10]</p> <p>Certains échantillons utilisés avec cet appareil peuvent contenir des agents infectieux. Manipulez ces échantillons avec la plus grande précaution et conformément aux règles de sécurité nécessaires. Portez toujours des lunettes de protection, deux paires de gants et une blouse de laboratoire. La personne responsable (par exemple, le directeur du laboratoire) doit prendre les précautions nécessaires afin de garantir que l'environnement de travail est sûr, que les opérateurs de l'appareil sont convenablement formés et ne sont pas exposés à des niveaux dangereux d'agents infectieux comme cela est défini dans les fiches techniques santé-sécurité (MSDS) ou dans les documents de l'OSHA*, de l'ACGIH[†] ou du COSHH[‡] applicables. L'évacuation des vapeurs et la mise au rebut des déchets doivent s'effectuer conformément à toutes les réglementations et lois nationales, régionales et locales relatives à la santé et à la sécurité.</p>
---	--

* OSHA : Occupational Safety and Health Administration (États-Unis d'Amérique) (Administration pour la santé et la sécurité du travail).

† ACGIH : American Conference of Government Industrial Hygienists (États-Unis d'Amérique) (Conférence américaine des hygiénistes industriels gouvernementaux).

‡ COSHH : Control of Substances Hazardous to Health (Royaume-Uni) (Contrôle des substances dangereuses pour la santé).

1.4 Produits chimiques

<p>AVERTISSEMENT</p> 	<p>Produits chimiques dangereux [W11]</p> <p>Certains produits chimiques utilisés avec cet appareil peuvent être dangereux ou le devenir après l'exécution du cycle du protocole.</p> <p>Toujours porter des lunettes de protection, des gants et une blouse de laboratoire.</p> <p>La personne responsable (par exemple, le directeur du laboratoire) doit prendre les précautions nécessaires afin de garantir que le lieu de travail environnant est sûr et que les opérateurs de l'appareil ne sont pas exposés à des niveaux dangereux de substances (chimiques ou biologiques) toxiques comme cela est défini dans les fiches de données de sécurité (FDS) ou dans les documents de l'OSHA *, de l'ACGIH † ou du COSHH ‡ applicables.</p> <p>L'évacuation des vapeurs et la mise au rebut des déchets doivent s'effectuer conformément à toutes les réglementations et lois nationales, régionales et locales relatives à la santé et à la sécurité.</p>
---	--

* OSHA : Occupational Safety and Health Administration (États-Unis d'Amérique) (Administration pour la santé et la sécurité du travail).

† ACGIH : American Conference of Government Industrial Hygienists (États-Unis d'Amérique) (Conférence américaine des hygiénistes industriels gouvernementaux).

‡ COSHH : Control of Substances Hazardous to Health (Royaume-Uni) (Contrôle des substances dangereuses pour la santé).

1.4.1 Vapeurs toxiques



Si vous travaillez avec des solvants volatils ou des substances toxiques, vous devez disposer d'un système de ventilation de laboratoire efficace afin d'évacuer les vapeurs qui peuvent être générées.

1.5 Traitement des déchets

Le matériel en plastique usagé peut contenir des produits chimiques dangereux. Ces déchets doivent être convenablement collectés et mis au rebut conformément aux réglementations de sécurité locales.

Pour plus d'informations sur la mise au rebut du QIAgility, voir l'Annexe A.

1.6 Dangers mécaniques

<p>AVERTISSEMENT</p> 	<p>Pièces mobiles [W12]</p> <p>Éviter le contact avec les pièces en mouvement lorsque le QIAgility est en marche. Ne jamais placer les mains sous le bras robotisé lorsque celui-ci s'abaisse. Ne pas tenter de déplacer des plaques ou des tubes lorsque le bras robotisé est en marche.</p>
<p>ATTENTION</p> 	<p>Détérioration de l'appareil [C3]</p> <p>N'appliquer aucune force manuelle sur le bras Y (c'est-à-dire la tête de pipetage). En cas de déplacement manuel accidentel du bras Y, il est fortement recommandé de redémarrer le système.</p>

Afin que le QIAgility fonctionne de manière satisfaisante et en toute sécurité, suivre les conseils suivants :

- Utiliser uniquement les tips et les supports de tips recommandés.
- Dans la mesure du possible, maintenir le capot de l'appareil fermé.
- Ne pas désactiver le dispositif de verrouillage du capot.
- Lors de la calibration des plaques capot ouvertes, toujours se tenir à l'écart de l'appareil au moment des réglages. Le dispositif de verrouillage est désactivé en mode de calibration. Par conséquent, ne pas cliquer avec la souris ni appuyer sur une des touches du clavier lors de l'observation de l'inspection visuelle de la calibration des plaques. Attendre l'arrêt complet du bras robotisé pour déplacer une plaque ou un tube.
- Ne rien poser sur le bras robotisé.
- Avant de retirer des plaques ou des tubes de la table de travail, sélectionner « Pause » dans la barre d'outils du logiciel QIAgility pour mettre l'appareil en mode de









pause. Attendre l'arrêt complet du bras robotisé. Cela peut prendre jusqu'à 10 s.



1.7 Sécurité relative à la maintenance

Procéder à la maintenance comme décrit à la Section 8. QIAGEN facture les réparations rendues nécessaires suite à une maintenance inappropriée.

<p>AVERTISSEMENT/ ATTENTION</p> 	<p>Risque d'accident corporel et de détérioration du matériel [W13] Effectuer uniquement la maintenance spécifiquement décrite dans ce manuel.</p>
<p>AVERTISSEMENT</p> 	<p>Risque de décharge électrique [W14] Risque d'accident corporel et de détérioration du matériel Ne pas ouvrir les panneaux du QIAgility. Effectuer uniquement la maintenance spécifiquement décrite dans ce manuel.</p>
<p>ATTENTION</p> 	<p>Détérioration de l'appareil [C4] Ne pas utiliser de solvants ni de réactifs contenant des acides, des bases ou des composés abrasifs pour nettoyer le QIAgility.</p>
<p>ATTENTION</p> 	<p>Détérioration du capot du QIAgility [C5] Ne pas utiliser de solvants ni de réactifs contenant des acides, des bases ou des composés abrasifs pour nettoyer le capot de l'appareil. L'alcool peut endommager le capot. Employer uniquement de l'eau distillée.</p>
<p>ATTENTION</p> 	<p>Détérioration des panneaux latéraux du QIAgility [C6] Ne jamais nettoyer le capot ou les panneaux latéraux de l'appareil à l'alcool ou avec une solution à base d'alcool.</p>

1.8 Symboles sur le QIAgility

Symbole	Emplacement	Description
	Table de travail et près de la plaque signalétique	Symbole de mise en garde
	Table de travail et près de la sortie des tips	Symbole de danger biologique
	Table de travail	Symbole de risque d'écrasement
	Plaque signalétique à l'arrière de l'appareil	Marque CE
	Plaque signalétique à l'arrière de l'appareil	Label CSA pour le Canada et les États-Unis
	Plaque signalétique à l'arrière de l'appareil	Fabricant légal
	Plaque signalétique à l'arrière de l'appareil	Symbole DEEE
	Plaque signalétique à l'arrière de l'appareil	Label FCC de la Federal Communications Commission des États-Unis

Symbole	Emplacement	Description
	Plaque signalétique à l'arrière de l'appareil	Marquage RCM (antérieurement marquage C-Tick) pour l'Australie (identifiant du fournisseur N17965)
	Plaque signalétique à l'arrière de l'appareil	Label RoHS pour la Chine (restriction de l'utilisation de certaines substances dangereuses dans l'équipement électrique et électronique)

This page intentionally left blank

Appendix D

Safety Information (German, DE)

1 Sicherheitshinweise

Lesen Sie dieses Handbuch sorgfältig durch, bevor Sie den QIAgility benutzen. Beachten Sie dabei insbesondere die Sicherheitshinweise. Die Gebrauchsanweisungen und Sicherheitshinweise im Handbuch müssen befolgt werden, um einen sicheren Betrieb des Geräts zu gewährleisten und das Gerät in einem sicheren Zustand zu erhalten.

In diesem Handbuch werden die folgenden Kategorien von Sicherheitshinweisen verwendet:

WARNUNG 	Der Begriff „ WARNUNG “ (“ WARNING “) weist Sie auf Situationen hin, in denen eine Verletzungsgefahr für Sie selbst oder andere Personen besteht. Nähere Einzelheiten über diese Situationen werden in einem Textfeld wie diesem beschrieben.
---	--

ACHTUNG 	Der Begriff „ ACHTUNG “ (“ CAUTION “) weist Sie auf Situationen hin, in denen das Gerät oder andere Geräte beschädigt werden könnten. Nähere Einzelheiten über diese Situationen werden in einem Textfeld wie diesem beschrieben.
---	---

Die in diesem Handbuch enthaltenen Hinweise stellen eine Ergänzung und keinen Ersatz der üblichen Sicherheitsanforderungen dar, die im jeweiligen Land gelten.

1.1 Sachgemäße Handhabung

<p>WARNUNG/ ACHTUNG</p> 	<p>Verletzungsgefahr und Beschädigung des Geräts [W1] Die unsachgemäße Bedienung des QIAgility kann zu einer Verletzung des Benutzers oder zur Beschädigung des Geräts führen. Der QIAgility darf nur durch qualifiziertes Personal, das entsprechend geschult wurde, bedient werden. Die Instandhaltung des QIAgility darf nur durch einen Außendienst-Mitarbeiter des QIAGEN Service durchgeführt werden.</p>
--	--

<p>WARNUNG/ ACHTUNG</p> 	<p>Überhitzungsgefahr [W2] Vergewissern Sie sich, dass zwischen Wand und QIAgility (Rückseite und Seitenteile) ein Mindestabstand von 10 cm eingehalten wird. Das gewährleistet eine ausreichende Belüftung des Gerätes. Die Lüftungsschlitze und Öffnungen, die für die Be- und Entlüftung des QIAgility bestimmt sind, dürfen nicht zugedeckt werden.</p>
--	--

<p>WARNUNG/ ACHTUNG</p> 	<p>Verletzungsgefahr und Beschädigung des Geräts [W3] Der QIAgility ist zu schwer, um von einer einzelnen Person gehoben zu werden. Zur Vermeidung einer Verletzung oder Beschädigung des Gerätes heben sie das Gerät nicht alleine an.</p>
---	--

<p>WARNUNG/ ACHTUNG</p> 	<p>Verletzungsgefahr und Beschädigung des Geräts [W4] Der QIAgility darf auf keinen Fall während des Betriebs fortbewegt werden.</p>
--	---

<p>WARNUNG/ ACHTUNG</p> 	<p>Explosionsfähige Atmosphären [W5] Der QIAgility ist nicht für den Gebrauch in explosionsfähigen Atmosphären vorgesehen.</p>
--	---

<p>WARNUNG/ ACHTUNG</p> 	<p>Explosionsgefahr [W6] Der QIAgility ist ausschließlich mit Reagenzien und Substanzen aus den QIAGEN Kits zu benutzen. Die Benutzung von anderen Reagenzien oder Substanzen kann Feuer oder eine Explosion auslösen.</p>
--	--

<p>ACHTUNG</p> 	<p>Geräteschäden [C1] Direktes Sonnenlicht kann zum Ausbleichen von Geräteteilen führen und Schäden an Kunststoffteilen verursachen. Der QIAgility darf nicht direkter Sonneneinstrahlung ausgeliefert werden.</p>
---	--

<p>ACHTUNG</p> 	<p>Beschädigung des Geräts [C2] Vermeiden Sie es, Wasser oder Chemikalien auf der Oberfläche des QIAgility zu verschütten. Durch verschüttete Chemikalien oder verschüttetes Wasser verursachte Geräteschäden sind nicht durch die Garantie abgedeckt.</p>
---	--

<p>WARNUNG</p> 	<p>Verletzungsgefahr [W7] Bei der Kalibrierung der Positionen bewegt sich der Roboterarm bei geöffneter Gerätehaube. Klicken Sie nicht auf die Maus und drücken Sie nicht auf eine Taste der Tastatur, während sich Ihre Hände oder andere Körperteile im Arbeitsbereich des Roboterarms befinden.</p>
--	--

Schalten Sie im Notfall den QIAgility aus (der Netzschalter befindet sich auf der Geräterückseite), und ziehen Sie den Netzstecker aus der Steckdose.

1.2 Elektrische Sicherheit

Ziehen Sie das Netzanschlusskabel aus der Steckdose, bevor Sie Wartungsarbeiten am Gerät vornehmen.

<p>WARNUNG</p> 	<p>Gefahr durch Stromschlag [W8]</p> <p>Jede Unterbrechung des Schutzleiters (Erdungs- bzw. Masseleiter) im Gerät oder außerhalb des Geräts und jede Abtrennung des Schutzleiters am Anschluss der Netzleitung erhöht die Gefahr eines Stromschlags. Eine absichtliche Unterbrechung der Schutzleiterverbindung ist verboten.</p> <p>Gefährliche Spannung im Gerät</p> <p>Wenn das Gerät an die Stromversorgung angeschlossen ist, sind die Anschlussstellen spannungsführend. Durch das Öffnen der Abdeckungen oder das Entfernen von Gehäuseteilen können spannungsführende Komponenten freigelegt werden.</p>
---	---

<p>WARNUNG</p> 	<p>Gefahr durch UV-Strahlung [W9]</p> <p>Eine elektronisch gesteuerte Verriegelung stellt sicher, dass die Gerätehaube geschlossen sein muss, bevor die UV-Lampe eingeschaltet werden kann. Diese Verriegelung sollte auf keinen Fall deaktiviert werden.</p>
---	---

Um einen zufriedenstellenden und sicheren Betrieb des QIAgility zu gewährleisten, befolgendes Sie bitte die nachstehenden Richtlinien:

- Das Netzkabel muss an eine Wechselstrom-Steckdose mit Schutzleiter (Erdungs-/ Masseleiter) angeschlossen werden.
- Nehmen Sie im Geräteinneren keine Einstellungen an Teilen vor und wechseln Sie keine Teile aus.
- Nehmen Sie das Gerät nicht in Betrieb, wenn Abdeckungen oder Teile entfernt worden sind.
- Falls Flüssigkeit auf dem Gerät verschüttet wird und in das Gerät läuft, dann schalten Sie es sofort aus, trennen Sie es von der Netzspannung (Stecker ziehen!) und setzen Sie sich mit dem Technischen Service von QIAGEN in Verbindung.

- Falls die elektrische Sicherheit bei der Bedienung des Geräts nicht mehr gewährleistet werden kann, muss das Gerät gegen unbefugte oder unabsichtliche Benutzung gesichert werden. Kontaktieren Sie anschließend den Technischen Service von QIAGEN. Die elektrische Sicherheit des Geräts ist nicht mehr gegeben, wenn:
 - das Netzkabel beschädigt ist;
 - das Gerät längere Zeit unter ungünstigen Bedingungen, d. h. unter anderen Bedingungen als in Anhang A angegeben, gelagert wurde;
 - das Gerät unsachgemäß transportiert worden ist.

1.3 Biologische Sicherheit

Bei Substanzen und Reagenzien, die humanes Untersuchungsmaterial enthalten, sollte immer von einer möglichen Infektionsgefahr ausgegangen werden. Wenden Sie nur sichere Laborverfahren an, wie sie z. B. in Veröffentlichungen wie *Biosafety in Microbiological and Biomedical Laboratories* (HHS, www.cdc.gov/biosafety/publications) beschrieben werden.

1.3.1 Proben

Proben können infektiöse Erreger enthalten. Sie sollten sich der Gesundheitsgefahr bewusst sein, die von diesen Erregern ausgeht, und derartige Proben gemäß den erforderlichen Sicherheitsbestimmungen handhaben, lagern und entsorgen.

<p>WARNUNG</p> 	<p>Proben, die infektiöse Erreger enthalten [W10]</p> <p>Einige Proben, die mithilfe dieses Geräts verarbeitet werden, können infektiöse Erreger enthalten. Gehen Sie beim Umgang mit diesen Proben mit der größtmöglichen Vorsicht und gemäß den erforderlichen Sicherheitsbestimmungen vor.</p> <p>Tragen Sie immer eine Schutzbrille, zwei Paar Laborhandschuhe und einen Laborkittel.</p> <p>Die verantwortliche Person (z. B. der Laborleiter) muss alle erforderlichen Vorsichtsmaßnahmen treffen, um sicherzustellen, dass die unmittelbare Umgebung des Arbeitsplatzes sicher ist und die Bediener des Geräts ausreichend geschult sind. Außerdem dürfen die Grenzwerte in Bezug auf infektiöse Erreger, die in den entsprechenden Sicherheitsdatenblättern (MSDS) oder den Vorschriften der OSHA,* ACGIH[†] oder COSHH[‡] festgelegt sind, nicht überschritten werden.</p> <p>Beim Betrieb des Abzugs und bei der Entsorgung von Abfallstoffen müssen alle Bestimmungen und Gesetze zu Gesundheitsschutz und Sicherheit am Arbeitsplatz auf übernationaler, nationaler und regionaler Ebene eingehalten werden.</p>
---	--

* OSHA: Occupational Safety and Health Administration (Vereinigte Staaten von Amerika)

† ACGIH: American Conference of Government Industrial Hygienists (Vereinigte Staaten von Amerika)

‡ COSHH: Control of Substances Hazardous to Health (Vereinigtes Königreich)

1.4 Chemikalien

<p>WARNUNG</p> 	<p>Gefährliche Chemikalien [W11]</p> <p>Einige Chemikalien, die mit diesem Gerät verwendet werden, können gefährlich sein oder nach Beendigung eines Protokolllaufs gefährlich werden.</p> <p>Tragen Sie immer eine Schutzbrille, Laborhandschuhe und einen Laborkittel.</p> <p>Die verantwortliche Person (z. B. der Laborleiter) muss alle erforderlichen Vorsichtsmaßnahmen treffen, um sicherzustellen, dass die unmittelbare Umgebung des Arbeitsplatzes sicher ist. Auch dürfen die Grenzwerte in Bezug auf infektiöse Erreger, die in den entsprechenden Sicherheitsdatenblättern (MSDS) oder den Vorschriften der OSHA*, ACGIH† oder COSHH‡ festgelegt sind, nicht überschritten werden.</p> <p>Beim Betrieb des Abzugs und bei der Entsorgung von Abfallstoffen müssen alle Bestimmungen und Gesetze zu Gesundheitsschutz und Sicherheit am Arbeitsplatz auf übernationaler, nationaler und regionaler Ebene eingehalten werden.</p>
---	---

* OSHA: Occupational Safety and Health Administration (Vereinigte Staaten von Amerika)

† ACGIH: American Conference of Government Industrial Hygienists (Vereinigte Staaten von Amerika)

‡ COSHH: Control of Substances Hazardous to Health (Vereinigtes Königreich)

1.4.1 Giftige Dämpfe

Alle Arbeiten mit flüchtigen Lösungsmitteln oder toxischen Substanzen müssen unter einem funktionierenden Laborabzugssystem durchgeführt werden, damit die möglicherweise entstehenden Dämpfe abziehen können.

1.5 Abfallentsorgung

Benutzte Kunststoff-Laborartikel können gefährliche Chemikalien enthalten. Derartige Abfälle müssen gemäß den geltenden regionalen Sicherheitsbestimmungen gesammelt und entsorgt werden.

Beachten Sie bei der Entsorgung des QI Agility die gesetzlichen Bestimmungen zur Entsorgung von Elektro- und Elektronik-Altgeräten (siehe Anhang A).

1.6 Gefahren durch mechanische Teile

WARNUNG 	Sich bewegende Geräteteile [W12] Vermeiden Sie jeglichen Kontakt mit sich bewegenden Geräteteilen, während der QI Agility in Betrieb ist. Auf gar keinen Fall dürfen sich Ihre Hände unter dem Roboterarm befinden, wenn dieser herunterfährt. Versuchen Sie nicht, Reaktionsgefäße oder Platten zu entnehmen oder zu bewegen, während der Roboterarm arbeitet.
---	--

ACHTUNG 	Beschädigung des Geräts [C3] Bewegen Sie den Y-Arm (den Pipettierkopf) nicht von Hand. Wir empfehlen dringend, einen Neustart des Systems durchzuführen, falls der Y-Arm versehentlich von Hand bewegt wurde.
---	---

Um einen zufriedenstellenden und sicheren Betrieb des QI Agility zu gewährleisten, befolgen Sie bitte die nachstehenden Richtlinien:



- Verwenden Sie nur die empfohlenen Pipettenspitzen und -Racks.
- Halten Sie die Gerätehaube möglichst immer geschlossen.
- Deaktivieren Sie nicht die Verriegelung der Gerätehaube.
- Wenn bei geöffneter Gerätehaube die Plattenpositionen kalibriert werden, achten Sie darauf, dass Sie nicht in den Arbeitsbereich des Roboterarms kommen, wenn Sie Justierungen vornehmen. Im Kalibrier-Modus ist die Verriegelung der Gerätehaube deaktiviert. Achten Sie deshalb darauf, nicht mit der Maus zu klicken oder eine der Bedienungstasten auf der Tastatur zu drücken, wenn Sie die Kalibrierungen der Plattenpositionen überprüfen.

Warten Sie, bis die Bewegungsabläufe des Roboterarms beendet sind, bevor Sie Reaktionsgefäße oder Platten entnehmen oder bewegen.

- Stellen Sie keine Gegenstände auf den Roboterarm.
- Wählen Sie die Option "Pause" in der Werkzeugleiste der QIAgility Software, um das Gerät anzuhalten, bevor Sie Reaktionsgefäße oder Platten von der Arbeitsplattform entfernen. Warten Sie, bis der Roboterarm die gerade ablaufende Bewegung beendet hat – dies kann bis zu 10 Sekunden dauern.

1.7 Sicherheitshinweise – Wartungsarbeiten









Führen Sie alle Wartungsarbeiten gemäß den Anweisungen in Abschnitt durch. QIAGEN stellt alle Reparaturen in Rechnung, die nachweislich auf eine inkorrekte Wartung zurückzuführen sind.



<p>WARNUNG/ ACHTUNG</p> 	<p>Verletzungsgefahr und Beschädigung des Geräts [W13] Führen Sie nur Wartungsarbeiten durch, die ausdrücklich in dieser Gebrauchsanweisung beschrieben sind.</p>
<p>WARNUNG/ ACHTUNG</p> 	<p>Gefahr durch Stromschlag [W14] Öffnen Sie keine Gehäuseteile des QIAgility. Verletzungsgefahr und Beschädigung des Geräts Führen Sie nur Wartungsarbeiten durch, die ausdrücklich in dieser Gebrauchsanweisung beschrieben sind.</p>
<p>ACHTUNG</p> 	<p>Beschädigung des Geräts [C4] Verwenden Sie weder Lösungsmittel noch Reagenzien, die Säuren, Laugen oder Abrasivstoffe enthalten, um das QIAgility zu reinigen.</p>

<p>ACHTUNG</p> 	<p>Beschädigung der QIAgility Gerätehaube [C5] Verwenden Sie weder Alkohol noch Lösungsmittel oder Reagenzien, die Säuren, Laugen oder Abrasivstoffe enthalten, um die QIAgility Haube zu reinigen. Alkohol schädigt die Gerätehaube. Verwenden Sie zum Reinigen der Gerätehaube ausschließlich destilliertes Wasser.</p>
---	--

<p>ACHTUNG</p> 	<p>Beschädigung der QIAgility Seitenwände [C6] Reinigung sie niemals die Gerätehaube und Seitenwände mit Alkohol oder alkoholhaltigen Lösungen.</p>
---	--

1.8 Symbole auf dem QIAgility

Symbol	Ort	Beschreibung
	Arbeitsplattform und nahe Typenschild	Symbol „Achtung“
	Auf der Arbeitsplattform und nahe „Tip chute“ Ausgang	Symbol „Biogefährdung“
	Arbeitsplattform	Symbol „Quetschgefahr“
	Typenschild auf der Rückseite des Instruments	CE-Kennzeichnung
	Typenschild auf der Rückseite des Instruments	Symbol der CSA-Zertifizierung in Kanada und den USA
	Typenschild auf der Rückseite des Instruments	Hersteller i. S. d. Gesetzes
	Typenschild auf der Rückseite des Instruments	WEEE-Kennzeichnung (gemäß europäischer Richtlinien bzw. Elektro- und Elektronik-Altgeräte-Verordnung)
	Typenschild auf Rückseite des Instruments	FCC-Kennzeichen der Federal Communications Commission der Vereinigten Staaten

Symbol	Ort	Beschreibung
	<p>Typenschild auf Rückseite des Instruments</p>	<p>RCM-Zeichen (ehemals C-Tick) für Australien (Anbieterkennzeichnung N17965)</p>
	<p>Typenschild Rückseite des Instruments</p>	<p>Markierung gemäß RoHS-Richtlinie für China (Beschränkung der Verwendung bestimmter gefährlicher Stoffe in Elektro- und Elektronikgeräten)</p>

Appendix E

ABI 7000/7500 SDS master mix naming conventions

Absolute Quantification

For absolute quantification, the ABI software requires each reaction to be associated with a detector, reporter and quencher. To achieve this, master mixes used in the exported reactions must be named in the QIAgility software according to the convention:

[?:]D_R_Q{:D_R_Q}

?	Indicates a string of characters, which excludes ":".
:	Is a separator.
D	Is a placeholder for detector.
R	Is a placeholder for reporter.
Q	Is a placeholder for quencher.
[]	Indicates an optional component.
{}	Indicates 0 or more items.

For example, "Mix C:EBV_FAM_TAMRA" specifies a mix with detector for EBV, using FAM reporter, and TAMRA quencher. The "Mix C" portion of the name is unused by the SDS software.

The absolute quantification function exports a single file, "XXX.TXT", where "XXX" is the filename.

Allelic Discrimination

For allelic discrimination, the ABI software requires each reaction to be associated with a marker, identifying a pair of

detector/reporter/quencher sets. To achieve this, master mixes used in the exported reactions must be named in the QIAgility software according to the convention:

M:D_R_Q:D_R_Q

“M” is the marker name. All other items are the same as for “Absolute Quantification”.

For example, “Mix D:CMV_FAM_TAMRA:EBV_JOE_TAMRA” specifies a mix with detector for CMV using FAM reporter and TAMRA quencher, and detector for EBV using JOE reporter and TAMRA quencher. “Mix D” represents the marker name in the SDS software.

The allelic discrimination function exports 2 files, “XXX.TXT” and “XXXend.TXT” (for endpoint analysis), where “XXX” is the filename.

Note: The “Absolute Quantification” and “Allelic Discrimination” export modes ignore reactions where the master mix name does not match the required format. In the resultant files, wells are only listed where their master mix contents are named, so that they can match the required format.

Appendix F

Advanced Settings

Advanced run settings are available to adjust specific applications on the QIAgility. These functions should be modified only under direct instructions from QIAGEN.

Tip pickup mode

This defines the strategy used for collecting tips from the Tip Rack Holder. "Normal (single stage)" or "Three Stage" can be selected.

Normal (single stage)	Instructs the instrument to collect tips using a single downward movement. This is the default setting.
Three Stage	Instructs the instrument to collect tips in 3 separate downward movements: <ol style="list-style-type: none">1. The pipetting head is brought into the tip collar.2. The pipetting head is gently pressed against the tip collar.3. The pipetting head is forced against the tip collar.

Detect tip absence

When activated, a tick is visible. This function automatically detects when the instrument has failed to pick up a tip. This is caused when a tip is absent from the pick-up position. A message is presented with options to ignore (and proceed as if the pickup succeeded), retry (attempt to pickup at the same location), abort (terminate the run), or skip (to the next available tip position and retry).

By default, this function is activated.

Automatically skip to next if detect tip absence

This function is disabled until “Detect tip absence” is enabled to be activated. When activated a tick is visible. This function automatically skips to the next available tip position and retries the tip pickup if a tip pickup fails due to tip absence.

By default, this function is not activated.

Compensate for liquid loss

This function sets a depth in millimeters by which the tip should be further lowered into the wells below the determined (or calculated) liquid surface position for pipetting operations. The default value is 0.

This function is intended for applications which use liquids that evaporate rapidly. In addition, this function can be used to address a variety of situations where the tip would otherwise be placed too high in the well for pipetting operations.

Note: Using this function may increase the amount of liquid carried on the exterior of tips.

Allow volumes > tip capacity (special operations)

When activated a tick is visible. By default, all of the liquid handling functions available from the “Special” button, presented on the “Reaction” right-hand pane, work only with volumes up to the largest capacity tip supported on the QIAgility (i.e., 200 µl). Activating this option allows those functions to work with volumes larger than 200 µl.

By default, this function is activated.

Reactions are mixed by default

When activated a tick is visible. This function sets the default setting of the “Mix on ejection?” option presented on the Mix Settings section of the “Reaction Configuration” dialog box shown when editing PCR setup liquid handling operations (displayed using the “Add” button of the

“Reaction” right-hand pane). When activated, the “Mix on ejection?” option is checked by default; when deactivated, this option is unchecked by default.

By default, this function is activated.

Allow preserved well indices

When activated a tick is visible. This function affects the options listed in the Target Wells section of the “Reaction Configuration” dialog box shown when editing PCR setup liquid handling operations (displayed using the “Add” button of the “Reaction” right-hand pane). When activated, the “Preserve source well indices” option is presented; when deactivated, this option is not presented.

The “Preserve source well indices” function changes the reaction well allocation strategy used by the software for the corresponding liquid handling operation. Normally, this function is disabled and the software allocates reaction wells sequentially from the first available well in the target plate not used by previous reaction setup operations in the run. When activated, the software attempts to use the well index in the reaction plate corresponding to the well index of the sample in the source plate for the reaction made using that sample.

The software applies special rules to allow reactions which “Preserve source well indices” and those which do not coexist in the same run. In short, for each reaction plate the software determines the highest index reaction well required by a “Preserve source well indices” liquid handling operation and treats the next well as the first available for all other reaction construction operations which do not “Preserve source well indices” in that plate.

By default, this function is activated.

Require extra volume in intermediate wells

When activated a tick is visible. By defining sample banks in reaction plates, it is possible to construct new reactions from others previously constructed. The wells in such sample

banks are considered to be intermediate reaction wells. By default, the software does not account for dead volumes of the intermediate wells when checking for underflow conditions. In practice this can result in shortages when aspirating from intermediate reaction wells. When this function is activated, the software will generate warnings if aspirates from intermediate wells would cause the well volume to fall below its dead volume.

By default, this function is not activated.

Advance Z-axis whilst aspirating

When activated a tick is visible. This function modifies the aspirate operation to reduce contact between liquid and the exterior of the tip. When activated, aspirates are performed by advancing the tip downwards into the well while aspirating, thereby approximately tracking the liquid surface during the operation.

By default, this function is not activated.

Retract Z-axis whilst dispensing

When activated a tick is visible. This function modifies the eject operation to reduce contact between liquid and the exterior of the tip. When activated, dispenses are performed by retracting the tip upwards from the well while ejecting, thereby approximately tracking the liquid surface during the operation.

By default, this function is activated.

Detect insufficient volume on aspirate

When activated a tick is visible. When using the level sensor during aspirate operations, the software calculates the volume present in the well based on the position of the liquid surface, and generates an error warning if the volume detected is less than the volume to be aspirated. When activated, this function suppresses this warning, allowing the operation to proceed regardless.

By default, this function is activated.

Level sensor false trigger handling options (aspirate)

False triggering occurs when the level sensor spuriously reports that it has found the liquid surface when it hasn't actually reached the liquid during its downward probe. The software considers all liquid surface levels found between the tube base and the top of tube to be valid, and reports false triggering errors when the level found by the sensor is above the top of the tube. Such conditions can occur when static electricity is present on the plasticware, as this may cause an apparent change in capacitance similar to that caused when the tip makes contact with liquid. False triggering which occurs within the tube is undetectable.

False triggering of the level sensor which occurs during aspirate operations usually causes insufficient volume to be aspirated and hence a deficiency in volume transferred to the target well.

This function presents options to reduce the impact of false triggering caused by static electricity. Recommended settings cause the pipettor to probe the surface at least twice looking for successive level detections which are within a small tolerance before proceeding with the aspirate.

By default, recommended settings to multiprobe the surface are activated.

Level sensor false trigger handling options (eject)

False triggering of the level sensor which occurs during eject operations may cause insufficient volume to be delivered to the target well.

This function presents options to reduce the impact of false triggering caused by static electricity. Recommended settings cause the pipettor to probe the surface at least twice looking for successive level detections which are within a small tolerance before proceeding with dispensing.

By default, recommended settings to multiprobe the surface are activated.

Use optimal height calibration where possible

As the mechanism used for automatic height calibration (Section 7.1.3) must account for several sources of measurement error, the software implements a compensation factor to ensure that tips do not contact the tube/well base during normal operation. As a consequence, the dead volumes for some tubes can be larger than is desirable.

This function activates an alternate height calibration mechanism which tries to optimize the calibrated tube/well height more closely to the true internal base of the vessel. Details are described below. While this may reduce the wasted dead volume, it also increases the risk that liquid may not be found during aspirate operations. Consequently, this function is offered only for selected vessels.

By default, this function is not activated.

Optimal plate height calibration

This function is activated by the 'use optimal height calibration where possible' advanced setting.

Before starting the procedure:

- Ensure that 50 μ l tips are available, that the Tip Rack Holder is calibrated, and that the correct tips are set as available.
1. Select "Options/Robot Setup/Calibrate plate height".
 2. The "Configure Plate Heights" dialog box will appear.

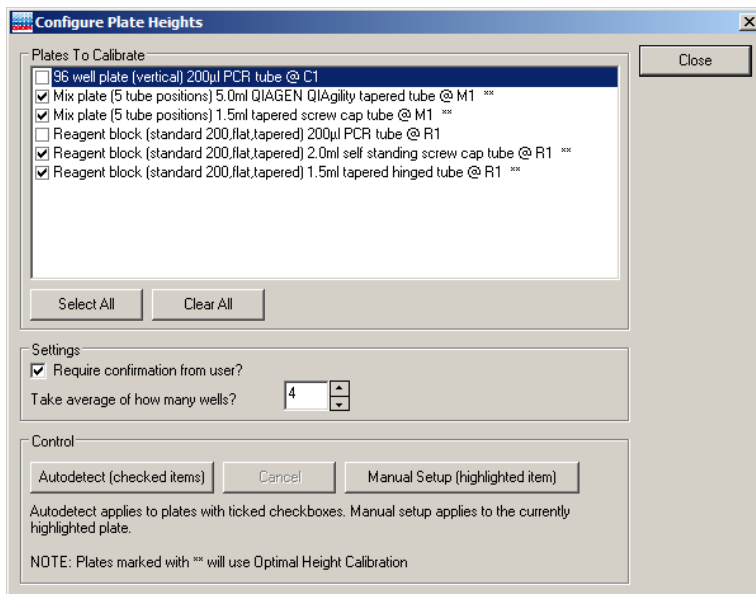

Plates to Calibrate	Lists the plates that are currently located on the worktable.
Select All	Selects all of the plates in the “Plates to Calibrate” list.
Clear All	Deselects all of the plates in the “Plates to Calibrate” list.
Require confirmation from user?	Instructs the software to present a message to the user after automatic plate height calibration is performed. This enables the user to confirm the value to be recorded as the auto-detected height.
Take average of how many wells?	Defines the number of wells from which to take an average.

Autodetect (checked items)	Initiates the automatic plate height calibration operation. Automatic plate height calibration is performed only for the selected plates.
Abort	Aborts the current calibration activity.
Manual Setup (highlighted items)	Initiates the manual plate height calibration operation. Manual plate height calibration is performed only for the selected plate.

A note indicates that workspace segments marked with a "***" symbol in the list of "Plates to Calibrate" are processed using optimal height calibration.

3. Check the boxes next to the plates to be calibrated in the "Plates to Calibrate" list. Alternatively, click on the "Select All" button to select all of the plates.
Note: Plates which have multiple segments (e.g., Reagent Blocks) are listed more than once, but with different tube types.
4. If user confirmation is required before saving the determined height calibration values, check the "Require user confirmation from user?" box.
5. Set the number of wells to measure in the "Take average of how many wells?" box. By default, this value is 4.
6. Click on the "Autodetect (checked items)" button to initiate calibration.
7. The "Optimal Height Autocalibration" form is presented. This displays a graphic of the first segment to be calibrated based on the selected checkboxes. It also indicates the wells to be calibrated, according to the selected number of wells to average. Ensure that empty tubes are present in the indicated well locations.

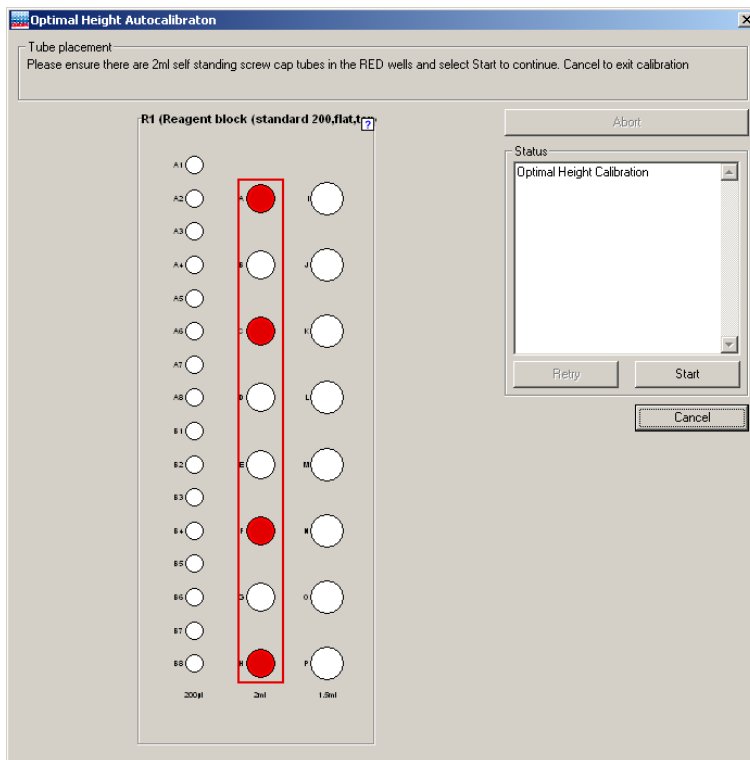

8. When ready, click the “Start” button to commence automatic height calibration. Where the segment contains vessels eligible for optimal calibration, the system uses a tip to probe the base of the vessel, discards it, then uses a second tip to probe again, cycling to tune the measured value. This process is repeated for each vessel to be measured. Where the segment is not eligible for optimal height calibration, a single tip is used to probe the base of the vessel and the process proceeds as described in Section 7.1.3, Automatic Height Calibration.
9. If “Require confirmation from user?” was selected, the Status region of the form shows the measured values, the calculated average, and the value determined as the height calibration. This value can be saved using the “Save” button, or the process at step 8 can be performed again by selecting “Retry”. If “Require

confirmation from user?" was not selected, the determined height calibration value is automatically saved.

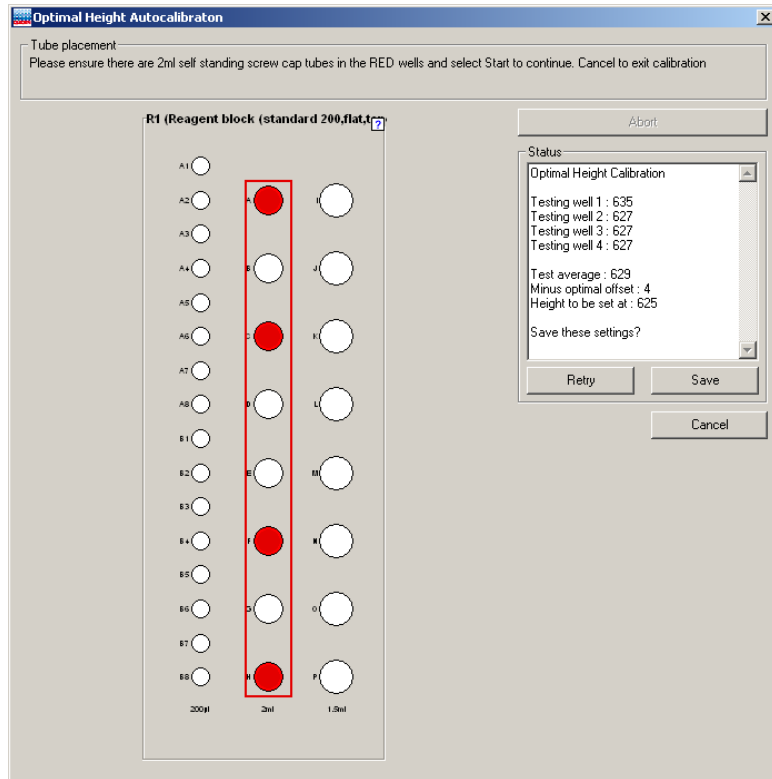

10. If more than one plate was selected in the "Plates to Calibrate" list, the instrument will calibrate each plate in turn. Repeat steps 8 and 9 for each plate.
11. When all calibrations are complete, click the "Close" button.

Appendix G

Description of the Generic XML Format

The XML file exported in Generic XML mode follows the schema defined in
 ...\\Integration\\xsd\\GenericXMLFormat.xsd.

The main structure is:

```

<Root>
  <ReactionData>
    <Socket>
      <Name>C1</Name>
      <PlateID/>
      <PlateType>Std96</PlateType>
      <Size>96</Size>
      <Wells>
        <Well>
          <Label>A1</Label>
          <WellID/>
          <WellNo>1</WellNo>
          <StandardWellName>A:1</StandardWellName>
          <Color>5775359</Color>
          <TubeType>BioSprint_250</TubeType>
          <Concentration>37</Concentration>
          <FinalWellVol>80</FinalWellVol>
          <EventOccurred>0</EventOccurred>
          <Contents>
            <Diluent>
              <SocketName>M1</SocketName>
              <WellLabel>A</WellLabel>
              <Vol>40</Vol>
            </Diluent>
            <Mix>
              <SocketName>M1</SocketName>
              <WellLabel>B</WellLabel>
              <Vol>10</Vol>
              <Name>Mix B</Name>
            </Mix>
            <Reagent>
              <SocketName>R1</SocketName>
              <WellLabel>I</WellLabel>
              <Vol>2.5</Vol>
              <Name>10X Buffer</Name>
            </Reagent>
          </Contents>
        </Well>
      </Wells>
    </Socket>
  </ReactionData>
</Root>

```

```
        <Vol>20</Vol>
        <Name/>
        <SampleID/>
        <Concentration>0</Concentration>
    </Sample>
    <Reaction>
        <SocketName>R1</SocketName>
        <WellLabel></WellLabel>
        <Vol>40</Vol>
        <Concentration>74</Concentration>
        <ReactionID/>
        <SourceContent/>
    </Reaction>
</Contents>
</Well>
```

...

For each reaction well a <well> tag is exported, that contains information of all contents of the well. The <reaction> tag contains recursive information, if a reaction was added to the exported well (e.g. when using "Create sample banks from target wells").

As the XML export can be used to export more than one plate, the <Socket> tag might be repeated for every exported plate data.

It is possible to create XSL transformation files to transform this generic XML format to the format you might need for your lab environment. This XSL file should be stored in the folder ...\\integration\\xsl. It can then be selected by the user during the XML export dialog.

To make the user's selection for empty wells and sample labels evaluable, two parameters are passed to the XSL transformation. These are:

SampleLabelType

Possible values:

SL_FullID = 0

SL_SampleID = 1

SL_ReactionID = 2

SL_SampleName = 3

and

EmptyLabelType

Possible values:

EL_Empty = 0

EL_WellID = 1

EL_WellOrder = 2

EL_WellNumber = 3

They can be evaluated during the transformation.

This page intentionally left blank

Appendix H

Packing the QIAgility

<p>WARNING/ CAUTION</p> 	<p>Risk of personal injury and material damage ^[W3]</p> <p>The QIAgility is too heavy to be lifted by one person. To avoid personal injury or damage to the instrument, do not lift the instrument alone.</p>
--	---

If you need to transport the QIAgility, package the instrument as follows:

1. Open the hood and remove all plates and tips from the worktable.
2. Shut down the QIAgility Software and switch off the QIAgility, as outlined in Section 6.9.
3. If installed, disconnect the UV lamp and HEPA filter from the instrument.
4. Reinstall the transport locks, see Section 4.5.
5. Disconnect the USB cable from the instrument to the computer and remove the AC power cord.
6. Place the QIAgility into the packaging in which it was originally shipped.

Appendix G

Copyright Information

The QIAgility software uses an XSLT template for scientific number to decimal conversion provided by Ludek Vodicka under MIT license.

Copyright (c) 2010 Ludek Vodicka

Permission is hereby granted, free of charge, to any person obtaining a copy of this software and associated documentation files (the "Software"), to deal in the Software without restriction, including without limitation the rights to use, copy, modify, merge, publish, distribute, sublicense, and/or sell copies of the Software, and to permit persons to whom the Software is furnished to do so, subject to the following conditions:

The above copyright notice and this permission notice shall be included in all copies or substantial portions of the Software.

THE SOFTWARE IS PROVIDED "AS IS", WITHOUT WARRANTY OF ANY KIND, EXPRESS OR IMPLIED, INCLUDING BUT NOT LIMITED TO THE WARRANTIES OF MERCHANTABILITY, FITNESS FOR A PARTICULAR PURPOSE AND NONINFRINGEMENT. IN NO EVENT SHALL THE AUTHORS OR COPYRIGHT HOLDERS BE LIABLE FOR ANY CLAIM, DAMAGES OR OTHER LIABILITY, WHETHER IN AN ACTION OF CONTRACT, TORT OR OTHERWISE, ARISING FROM, OUT OF OR IN CONNECTION WITH THE SOFTWARE OR THE USE OR OTHER DEALINGS IN THE SOFTWARE.

Index

- ABI software naming, 1
- Access control, 5-24
- Accessories, 5-51
- Accessory panel, 3-7
- Adapters, 3-11
- Advanced settings, 1
- Attention, 1
- Avertissement, 1
- Calibration, 7-1
 - optimal plate height, 6
 - plate height, 7-7
 - plate position, 7-4
 - tip ejector, 7-1
 - tip offset, 7-11
 - volume, 7-14
- Cautions, 1-1
- Cleaning, 8-2
- COM port, 5-146
- Computer, 3-14
 - connecting, 4-18
- Conductive Filtered Tips, 3-13
- Decontamination, 8-3
- Dilution series, 5-63
- Errors, 6-13, 9-5
 - error codes, 9-8
- Exporting data, 5-112
- Feet, 3-3
- Fumes, 1-6
- Generic XML Format, 1
- Glossary, 10-1
- HEPA filter, 6-5
 - replacement, 8-5
 - use, 3-4
- Importing data, 5-112
- Installation, 4-1
 - COM port, 4-18
 - computer setup, 4-7
 - HEPA filter, 4-7
 - power cord, 4-19
 - releasing the transport locks, 4-5
 - requirements, 4-1
 - software, 4-7
 - UV lamp, 4-7
- Instrument lid, 3-3
- Intended use, 2-3
- Lid, 3-3
- Liquid-level tracking
 - liquid-level estimate, 3-14
 - liquid-level sensing, 3-13
- Log files, 6-17
- Maintenance, 8-1
- Master mix block, 3-10
- Operating conditions, 1
- Operation, 6-1
 - pausing/aborting a run, 6-12
 - preparing the worktable, 6-10
 - software, 6-1
 - starting a run, 6-11
- Packing, 1
- Pipetting head, 3-9
 - use, 3-6
- Plate functions
 - diluent, 5-50
 - mix, 5-50, 5-67
 - reaction, 5-50, 5-81
 - reagent, 5-50, 5-65

- sample, 5-49, 5-77
- standard, 5-50, 5-60
- tip, 5-50, 5-59
- Post-run report, 6-16
- Power connection, 4-3
- Pre-run report, 6-14
- Q Protocols, 6-5
 - "QProtocols" folder, 4-17
- QIAgility
 - hardware features, 2
 - internal features, 3-8
 - mechanical data, 2
- Reagent Block, 3-10
- Right-hand pane
 - mix, 5-67
 - progress report, 5-127
 - reaction, 5-81
 - reagent, 5-65
 - sample, 5-77
 - standard, 5-60
 - tip, 5-59
- Robotic arm, 3-6
- Safety, 1-1
 - biological, 1-4
 - chemicals, 1-5
 - electrical, 1-3
 - infectious agents, 1-4
 - maintenance, 1-8
 - mechanical hazards, 1-7
 - proper use, 1-1
- Safety position, 6-21
- Sample tubes, 3-12
- Sécurité
 - dangers mécaniques, 8
 - électrique, 4
 - produits chimiques, 7
 - utilisation appropriée, 2
- Servicing, 8-1
 - service register, 5-147
- Sicherheit
 - Chemikalien, 7
 - elektrische, 3
 - Gefahr durch mechanische Teile, 8
 - sachgemäße Handhabung, 2
- Software, 5-1
 - "QProtocols" folder, 4-17
 - empty project, 5-142
 - folders, 4-16
 - Hardware Wizard, 4-19
 - installation, 4-8
 - main software window, 5-3
 - menu bar, 5-4
 - mode indicator, 5-16
 - multi-eject options, 5-44
 - Optimisation Wizard, 5-136
 - PCR Setup Wizard, 5-127
 - plate buttons, 5-18
 - plate function, 5-49
 - plate type, 5-49
 - reaction list, 5-90
 - required volumes, 5-146
 - right-hand pane, 5-19, 5-59
 - sample banks, 5-54
 - service register, 5-147
 - shutting down, 6-20
 - software worktable, 5-17
 - tip availability, 5-53
 - tip usage, 5-42
 - toolbar, 5-14
 - uninstalling, 4-15
 - virtual mode, 5-2

- Storage conditions, 1
- Support packages, 6-18
- Symbols, 1-9
- Technical assistance, 2-2
- Tip chute, 3-4, 8-4
- Tip disposal box, 3-6
- Tip ejector, 3-9
- Tip rack holders, 3-13
- Transport locks, 4-5
- Transportation conditions, 1
- Troubleshooting, 9-1
 - self diagnostic tools, 9-10
- Unpacking, 4-3
- USB interface, 4-18
- User classes, 5-21
- User management, 5-21
- UV lamp, 6-3
 - use, 3-5
- Virtual mode, 5-2
- Virtual Mode, 5-147
- Warnhinweise, 1
- Warnings, 1-1, 6-13, 9-5
- Waste disposal, 1-6, 2
- Wizards
 - Hardware Wizard, 4-19
 - Optimisation Wizard, 5-136
 - PCR Setup Wizard, 5-127
 - Volume Calibration, 7-15
- Worktable, 3-6, 3-9, 5-45, 6-10
- X-axis, 3-9
- Y-arm, 3-9
- Y-axis, 3-9
- Z-axis, 3-9

This page intentionally left blank

www.qiagen.com

Australia ■ techservice-au@qiagen.com

Austria ■ techservice-at@qiagen.com

Belgium ■ techservice-bnl@qiagen.com

Brazil ■ suportetecnico.brasil@qiagen.com

Canada ■ techservice-ca@qiagen.com

China ■ techservice-cn@qiagen.com

Denmark ■ techservice-nordic@qiagen.com

Finland ■ techservice-nordic@qiagen.com

France ■ techservice-fr@qiagen.com

Germany ■ techservice-de@qiagen.com

Hong Kong ■ techservice-hk@qiagen.com

India ■ techservice-india@qiagen.com

Ireland ■ techservice-uk@qiagen.com

Italy ■ techservice-it@qiagen.com

Japan ■ techservice-jp@qiagen.com

Korea (South) ■ techservice-kr@qiagen.com

Luxembourg ■ techservice-bnl@qiagen.com

Mexico ■ techservice-mx@qiagen.com

The Netherlands ■ techservice-bnl@qiagen.com

Norway ■ techservice-nordic@qiagen.com

Singapore ■ techservice-sg@qiagen.com

Sweden ■ techservice-nordic@qiagen.com

Switzerland ■ techservice-ch@qiagen.com

UK ■ techservice-uk@qiagen.com

USA ■ techservice-us@qiagen.com